

Be safe. Be sure



SHOCKS, STRUTS,
CARTRIDGES & GASLIFTS

2014-2015



Torre Automotive

Torre Automotive (Pty) Ltd, a subsidiary of the JSE listed Torre Industries Limited, manufactures and distributes quality branded products to the automotive aftermarket in Sub-Saharan Africa. The company, established in 1948, and formerly known as Control Instruments Automotive, has a significant basket of products. Brand names owned and/or exclusively distributed by Torre Automotive include Gabriel, Echlin, Textar, VDO, Autocom, Acsa-Mag, Mag Brakes, Warn, Hi-Lift, Vision X and Truck-Lite.

Based in City Deep in Johannesburg, with manufacturing facilities in Retreat, Western Cape, Torre Automotive employs some 450 people dedicated to its sales, marketing, warehousing, distribution and manufacturing operations, serving a network of wholesale distributors, in South Africa and the rest of Africa.

Torre Automotive is an ISO9001, ISO14001, and SABS certified company.

To read more about Torre Automotive please visit www.torreautomotive.co.za





Torre
Industries

Torre Industries

Torre Industries Ltd is a Johannesburg Stock Exchange (JSE) listed industrial group that provides engineering, equipment and financing solutions to customers in selected, global markets.

Torre Industries' business is the value added distribution of branded capital equipment products; the sale of complementary industrial consumable products and services; and the provision of specialised financial solutions to industrial customers in the areas of financing, foreign exchange, treasury and corporate advisory services.

To read more about Torre Industries please visit www.torreindustrial.com.

How to use the Catalogue		2
SHOCKS, STRUTS & CARTRIDGES		
	Overview	7
	Product Range	8
	New Releases	13
	Vehicle Listing	19
	Parts Listing	69
	Parts Finder	137
	Technical Information	161
	• Key to Mounting Codes	162
	• How to Protect your Struts	162
	• How to Measure Extended and Collapsed Lengths	162
	• Technical guide to drawings	163
	• Removal and fitment of shocks	164
	• Removal and fitment of struts	165
	• Parts Listing	166
GASLIFTS & STEERING DAMPERS		
	Product Range and General Information	176
	Vehicle Listing	178
	Parts Listing	180
	Parts Finder	182
	Technical Information	183
	• Universal Gaslifts	183
	• Gas Filling Machine	183
	• Custom Range Gaslifts	184
	• Extended & Collapsed Lengths	185
	Steering Dampers	187
TERMS & CONDITIONS		
Warranty Policy		188
Processing a Warranty		189
Brands of Torre Automotive		193

HOW TO USE THE CATALOGUE

VEHICLE LISTING

Vehicle make sorted in alpha-numeric order

Vehicle model sorted in alpha-numeric order

Model derivative sorted in alpha-numeric order

Vehicle or shock specific information (refer to the fitment guide on page 6)

Part number Italic if OBS. (Obsolete)

Icon indicates shock type. Refer to page 5 for more details

The first part number is for the left hand side and the second part number for right hand side

Part number status is either blank (active), NEW or OBS. (obsolete)

Model	Derivative	Year	Vehicle Type	Note #	FRONT					REAR					GASLIFT	
					Shock Info	Part #	Side	Range	Status	Shock Info	Part #	Side	Range	Status	Front	Rear
ALFA ROMEO																
155	2.0 (Exc 155)	96-98				<i>G35037</i>	↔	Gas Ryder	OBS.		<i>69919</i>	↔	Gas Ryder			
156	2.0 Twin Spark (932) (Excl. VETO116246 Right)	98-06				<i>G51217</i>	↔	Gas Ryder			<i>G35280</i>	↔	Gas Ryder	OBS.	4521 Left 4522 Right	
BEDFORD																
KE, KG, KH All	Truck	64 on	g	14		<i>76015</i>	↔	Fleet Ryder			<i>76015</i>	↔	Fleet Ryder	NEW		
						<i>G56126</i>	↔	Safari			<i>G56126</i>	↔	Safari			
BMW																
1 Series	E81 3-Door (Excl. Sport Susp. & 135i)	19...				<i>70577</i>	L	Gas Ryder			<i>69102</i>	↔	Gas Ryder			
						<i>70578</i>	R	Gas Ryder			<i>69102</i>	↔	Gas Ryder			

Vehicle introduction year to replacement year. For open ended periods (19...) search by model, not period

Vehicle type. Refer to page 5 for more information

Fitment position (L – Left, R – Right) or both sides (↔)

Range options available for the same vehicle model. The first listed is the preferred brand and those that follow are the alternatives.

NEW – Please refer to page 13

PARTS LISTING

Part numbers in alpha-numerical order

Product range

Icon and figure indicates shock type. Refer to page 5 and page 163 for more details

Refer to vehicle listing keys as per above

Vehicle or shock specific information (refer to page 6)

Part #	Range	Superceding Part # /Status.	Product Type	Make	Model	Derivative	Year	Position	L/R	Note #	
18727	Technomatic			8.5	Volkswagen	Beetle	Mk I	52-79	Front	↔	4
					Volkswagen	Kombi	Microbus, Fleetline (swing axle rear)	55-78	Front	↔	
					Volkswagen	Kombi	Microbus, Fleetline (swing axle rear)	55-78	Rear	↔	
19022	Technomatic	NEW		6.2	Renault	R8, R10	Small Sedan	62-70	Front	↔	
					Austin, Morris	Mini	Excl. Hydrolastic Susp.	59-85	Rear	↔	21
					Austin, Morris	Mini	Incl. Cooper	59-80	Rear	↔	
					Austin, Morris	Mini	Incl. Mk III	61-79	Rear	↔	
19289	Technomatic	OBS.		4	Nissan	Langley, Pulsar	Incl. Panache (N10)	80-83	Rear	↔	

Refer to footer of page

HOW TO USE THE CATALOGUE

NEW RELEASES

Make	Model	Derivative	Year	Position	L/R	Part #	Range	Released
Audi	A4	B8	08 on	Front	↔	69119	Gas Ryder	
				Rear	↔	62057	Gas Ryder	
BMW	5 Series	E60 Series	04-10	Front	↔	70722	Gas Ryder	
				Rear	↔	69121	Gas Ryder	
BMW	X3	(E83) 2.5, 3.0 & 2.0D	04-10	Front	L	70642	Gas Ryder	
				Front	R	70643	Gas Ryder	
Chery	QQ3	0.8, 1.1 (S11)	08 on	Front	L	35955	Technomatic	✓
				Front	R	35956	Technomatic	✓
				Rear	↔	36875	Technomatic	✓

PARTS FINDER

Reference to brands, trademarks or manufacturers part numbers are for reference and identification purposes only

Part #	Manufacturer	Gabriel		Model/Year/Side
		Primary	Alternative	
R1000	Monroe	G45006		
R1581	Monroe	G45418		
R1581	Monroe	G63423		
343185	KYB	G45122		
343187	KYB	G45860		Rear Left
343367	KYB	G56116	G45872	
721573	Gabriel Europe	35018		Rear Right
721574	Gabriel Europe	35094		Rear Left
721583	Gabriel Europe	55872		

- Manufacturers part numbers in alpha-numerical order
- Alternative part manufacturers
- The primary recommended alternative
- An additional recommended alternative
- Additional information

HOW TO USE THE CATALOGUE

TECHNICAL INFORMATION – Extended and collapsed lengths

Collapsed Length	Extended Length	Upper Mounting	Lower Mounting	Shock Type			Part #
				Fig	Icon	Code	
GABRIEL GAS RYDER							
MACPHERSON STRUT – WITHOUT SPRING SEAT							
297	489	M12x1.25x23	B	1,2		RE/RE	55802
SPRING SEAT SHOCK ABSORBERS – STUD UPPER, U BRACKET LOWER							
422	672	S	UB	3,3		SS/UB	69082
436	580	S	UB	3,3		SS/UB	69087
459	580	S	UB	3,3		SS/UB	651097
GABRIEL® HEAVY DUTY							
SHOCK ABSORBERS – STUD UPPER AND LOWER							
199	303	S	S	5		S/S	83233
SHOCK ABSORBERS – STUD UPPER, RUBBER EYE LOWER							
318	506	S	RE20	6,1		S/RE	83454

Annotations for the table above:



















- Type of damper by figure number, icon and code (refer to page 163 for more information)
- Damper part numbers
- The listings are segmented by range
- The different type of dampers in each range are listed by type
- The dampers are listed by their fully collapsed lengths
- Length of damper when fully extended
- Mounting Code at the top of the damper – refer to list in technical section
- Damper part number

KEY DESCRIPTIONS – Mounting Codes















Rubber Eyes	Sleeved Eyes	Other		
RE 16 = 16 mm I.D	SE 9 = 9 mm I.D	SE 16 = 16 mm I.D	B = Bracket	P = Plate
RE 17 = 17 mm I.D	SE 10 = 10 mm I.D	SE 19 = 19 mm I.D	BP = Bar Pin	S = Stud
RE 20 = 20 mm I.D	SE 11 = 11 mm I.D	SE 20 = 20 mm I.D	BT = Bolt	SM = Special Mounting
RE 22 = 22 mm I.D	SE 12 = 12 mm I.D	SE 22 = 22 mm I.D	C = Cartridge	SS = Spring Seat Stud
RE 25 = 25 mm I.D	SE 13 = 13 mm I.D	SE 24 = 24 mm I.D	DS = Dual Stud	SSE = Spring Seat Sleeved Eye
	SE 14 = 14 mm I.D	SE 25 = 25 mm I.D	I.D = Inner Diameter	UB = U Bracket
	SE 15 = 15 mm I.D	SE 31 = 31 mm I.D		

HOW TO USE THE CATALOGUE

KEY DESCRIPTIONS – Icons

	All models		Electronically adjustable suspension
	Passenger Car/Sedan (4 door)		Sport suspension
	Hatchback/Fastback		Self levelling suspension
	Estate/Station wagon	L / Left	Left hand side
	Coupe	R / Right	Right hand side
	Convertible	← →	Both Left and Right Hand Side
	LCV/Pick-up/Bakkie	Excl.	Excluding
	Panel van/Commercial	Incl.	Including
	Minibus	Susp.	Suspension
	MPV	Part #	Part number
	SUV	Fig 1	Gabriel® MacPherson Strut
	Panel van/Truck	Fig 2	Gabriel® MacPherson Cartridge
	Chassis Cab	Fig 3	Gabriel® Springseat Shock Absorber
g	Truck	Fig 4 to 13	Gabriel® Shock Absorbers
	Trailer	Fig 14	Gabriel® Gaslift®
	Bus	Fig 15	Gabriel® Steering Damper

Refer to technical guide to drawings on page 163 for more information

	Gabriel® MacPherson strut		Eye and stud shock absorber
	Gabriel® MacPherson cartridge		Eye and barpin shock absorber
	Gabriel® Springseat shock absorber		Eye and special mounting shock absorber
	Stud and barpin shock absorber		Barpin and stud shock absorber
	Stud and stud shock absorber		Barpin and eye shock absorber
	Stud and eye shock absorber (with or without dust cover)		Gabriel® Gaslift®
	Stud and special mounting shock absorber		Gabriel® Steering damper
	Eye and eye shock absorber		

HOW TO USE THE CATALOGUE

FITMENT GUIDE INSTRUCTION NOTES*

Note	Fitment Guide
1	Fit 2.5mm spacer either side lower sleeve front mounting
2	For rear use 414075 for lower mounting
3	For rear use sleeve 414164 and 414081 – top and bottom
4	Imported Beetle front use 19289, remove bar pin, fit 404702 + 414167
5	Remove lower sleeve
6	Remove top front shock bushing – fit 404702 plus 414167 remove sleeve lower mount
7	Re-use rear lower mounting bushes
8	Re-use rear lower mounting bushes. Using G45874 OR 61242 upside down does not work
9	Re-use spring seat upper mounting and bump rubber for rear shock
10	Use 414371 retainer (M48 x 1.0) for front
11	Use existing rear mounting
12	Use existing upper front mounting
13	Use existing upper rear assembly
14	Use existing upper rear mounting
15	Use kit 140729 for rear
16	Use kit 144028 x 2 for front and rear mountings
17	Use retainer 414334 with RS2000

Note	Fitment Guide
18	Use retainer 414363 (M48 x 1.5) when replacing Bilstein O.E. front units. Use existing upper rear mounting
19	Use sleeve 414167 lower for rear mounting
20	Use sleeve 414167 upper and lower for rear
21	When replacing struts with welded brake brackets use 414480 & 414481 brackets for rear
22	With rear lower eye mounting
23	With rear lower mounting bracket
24	Only fits applications with one pin at the bottom strut mounting
25	Re-use spring seat, upper mounting and bump rubber for rear shock
26	76042 for models with 25mm rubber bushes upper and lower. 76017 for models with 20mm sleeves upper and lower
27	77022 with Neway ARD 125/244 air suspension. 77018 with Hendrickson TA 460 air suspension
28	O.E. 16-13947-000 or 6913260400 for 85319 and O.E. 16-13957-000 or 680339 for 85724
29	Some use G56102 with 16mm eyes
30	Use 20mm spacer on lower mounting
31	Use 4 x 401754 rubber bushes
32	Use rubber bush 414323 x 2 for front and rear
33	Refer to fitment instructions located inside the box

* Should a fitment guide number not be specified, please revert to the standard fitment instructions on pages 164 and 165



OVERVIEW – SHOCKS, STRUTS & CARTRIDGES

Gabriel designs, engineers and manufactures shock absorbers for both the South African and international markets.

Gabriel's state of the art manufacturing facility (based in Retreat, Cape Town) houses its own product development, engineering and manufacturing divisions whereby products is designed and manufactured to the highest quality standards and distributed throughout the African continent.

All genuine Gabriel products are comprehensively tested by a team of qualified engineers and Gabriel's comprehensive range of shock absorbers are specifically designed and engineered to suit local South African conditions.

The Gabriel range includes:

- Gas and hydraulic shock absorbers
- MacPherson struts and cartridges
- Steering dampers
- Gaslifts®
- Accessories

The Gabriel product range is supplied through its wide distribution network under the following well known brands:

- Gabriel® Gas Rider™
- Gabriel® Safari™
- Gabriel® Safari HDP™
- Gabriel® Technomatic™
- Gabriel® Fleet Ryder®
- Gabriel® Gaslifts®

Drivers who use Gabriel shock absorbers comment on the smooth ride of their vehicles, however shock absorbers are not just for comfort – their primary purpose is to keep the wheels in contact with the road surface. Shock Absorbers also affect the steering, handling and braking of your vehicle, which is why they are vital for your safety.

Our years of research and testing have resulted in Gabriel developing shock absorbers that are firm enough to prevent the wheels from leaving the road surface, but also flexible enough to ensure that the occupants are not directly subjected to the vehicle's forces.

Gabriel shock absorbers limit the bounce of the wheels by controlling the rate at which the suspension springs compress and extend. In doing so, the shock absorbers help maintain traction and control of the body, as well as the pitch and roll of the car during cornering, braking and acceleration. With more accurate control and steering, Gabriel shock absorbers enhance safety through good road holding.







PRODUCT RANGE

PRODUCT FEATURES AND BENEFITS

Product Area	Product Type	Product Feature and Benefits	Brand:						
			Vehicle Type:	Passenger vehicles, MPV & SUV		MPV, SUV, LDV, MCV & Older Passenger Cars		MCV, HCV	Vehicle & Industrial
			Range:	Premium Range	Standard Range	On & Off Road Range	On & Off Road Heavy Duty Range	Heavy Duty Truck and Bus Range	Vehicle & Industrial Gas Stay Range
Design Type	Shock Absorber	Designed for all types of vehicles	✓	✓	✓	✓	✓		
	Spring Seat	Designed for mainly passenger and SUV's	✓	✓	✓	✓			
	Gaslift	Designed for automotive and industrial applications						✓	
	Twin Tube	Designed for all types of vehicles	✓	✓	✓	✓	✓		
	Mono Tube	Designed for mainly SUV's and MPV's	✓		✓	✓			
	MacPherson Struts	Designed for mainly passenger vehicles	✓	✓					
Suspensions	Standard	The vast majority of vehicles in South Africa	✓	✓	✓	✓	✓		
	Air Suspensions	A limited amount of vehicles in South Africa					✓		
	Raised	Specialist vehicle applications, Mainly custom 4x4's				✓			
Bore Size	Working Cylinder Bore Size (mm)	The larger the bore size the better the energy disbursement	27/30/32/36	27/32	32	35/41/46	41/52	19/22	
Oil	Custom Formulated Oil	Specially formulated oil to meet Gabriel's specifications	1200 C	1200 C	1200 C	1800 C	1200 C	80°C	
Gas and Pressures	Hydraulic	Standard feature on most shocks		✓			✓		
	Low Pressure gas	Gives a faster response time and less chance of the oil foaming		✓	✓			Variable pressure	
	Nitrogen infused	Gives a much faster response time and less chance of the oil foaming	✓	✓	✓	✓			
	High Pressure	Gives exceptional ride control and a quicker response time	✓			✓			
Bushing	Natural Rubber	Specifically designed for greater control	✓	✓	✓	✓	✓		
	Polyurethane	Specifically designed for great control and is harder wearing			✓	✓			
Seals	Viton or rubber rod seals	Designed to withstand high operating temperatures	✓	✓	✓	✓			
	Single lip rod seals	Designed as a standard feature with good wear properties	✓		✓		✓	✓	
	Multi lip rod seals	Specifically designed for better sealing and longer life expectancy	✓	✓	✓		✓		
	Rubber o-ring piston seals	Designed as a standard feature with good wear properties	✓						
	PTFE band o-ring piston seals	Specifically designed for reducing friction and providing longer product usage	✓	✓	✓				
	Cast iron o-ring piston seals	Specifically designed for reducing friction and providing longer product usage				✓	✓		
Rods and Product Finishing	Chrome plated & trication of zinc phosphate shaft (piston rod)	Highest quality finish on rods to reduce wear and protect against rust.	✓	✓	✓	✓	✓	✓	
	Sintered (combination of metals) metal rod guides	Standard feature on most Gabriel shocks	✓	✓	✓				

PRODUCT RANGE

PRODUCT FEATURES AND BENEFITS

Product Area	Product Type	Product Feature and Benefits	Brand:	     					
			Vehicle Type:	Passenger vehicles, MPV & SUV		MPV, SUV, LDV, MCV & Older Passenger Cars		MCV, HCV	Vehicle & Industrial
			Range:	Premium Range	Standard Range	On & Off Road Range	On & Off Road Heavy Duty Range	Heavy Duty Truck and Bus Range	Vehicle & Industrial Gas Stay Range
Additional Design Criteria	Cast iron piston ring	Allows for greater durability in high operating temperatures than the alternative Teflon type rings.				✓	✓		
	Teflon DU piston band insert	Designed to reduce friction between the rod and rod guide	✓	✓	✓				
	Bump Stop support	Designed to stop metal to metal contact and such damage to the shock	✓	✓					
	Strike Plate bump stop support	Designed to stop metal to metal contact and such damage to the shock		✓	✓				
	Velocity sensitive valving	Specifically designed to adjust the ride and handling performance based on differing factors such as road surface and speed.	✓			✓			
	Hydraulic stop lock	Designed to prevent metal to metal contact under full extension and such damage to the shock				✓			
	360° Reinforce welded mounts	Increased weld strength for extreme conditions as opposed to 180 and tack welds				✓			
	Solid machined eye rings	Provides for stronger and more durable mountings as opposed to non-solid types	✓			✓			
Colouring	White	Electrostatically applied paint (cosmetic)		✓	✓			✓	
	Black	Electrostatically applied paint (cosmetic)	✓				✓	✓	
	Green	Electrostatically applied paint (cosmetic)				✓			
Dust Covers	Metal	A Standard feature that protects your product from damage	✓	✓	✓		✓		
	Rubber/Plastic	A Standard feature that protects your product from damage	✓	✓		✓			
Accreditation	ISO 9000	Piece of mind that our quality production standards are met (International)	✓	✓	✓	✓	✓	✓	
	ISO 14001	Piece of mind that our quality production standards are met (International)	✓	✓	✓	✓	✓	✓	
	SABS	Piece of mind that our quality production standards are met (local RSA)	✓	✓	✓	✓	✓	✓	
Warranty Period	Standard - Time (Years)	Gabriel quality guarantee	3	3	3	3	1	1	
	Standard - Distance (Km)	Gabriel quality guarantee	Unlimited	Unlimited	Unlimited	Unlimited	20 000	Unlimited	
	Extended 3 to 5 Year	Gabriel quality guarantee	✓	✓	✓	✓			

PRODUCT RANGE

GABRIEL® GAS RYDER™

The Gabriel Gas Ryder Series offers an extensive range of South African shock absorbers, spring seat shock absorbers, MacPherson struts and MacPherson cartridges for passenger cars, sports cars, station wagons, small LCV's, MPV's and SUV's.

With the unique nitrogen gas-pressured dynamic response design, Gabriel Gas Ryder gives both an exceptional ride as well as a quicker response time compared to ordinary shock absorbers – the ultimate in both comfort and safety.

Allowing for greater ride control and performance, comfort and ultimately safety, the Gabriel Gas Ryder and its Gabriel warranty delivers up to its historical South African pedigree and provides for total driving peace of mind.



GABRIEL® GAS RYDER™ STRUT



GABRIEL® GAS RYDER™ SPRING SEAT



GABRIEL® GAS RYDER™ SHOCK



GABRIEL® GAS RYDER™ CARTRIDGE

GABRIEL® TECHNOMATIC™

The Gabriel Technomatic Series offers an extensive range of robust and genuine South African shock absorbers, spring seat shock absorbers, MacPherson struts and MacPherson cartridges for today's passenger cars. Station wagons, MPV and LCV applications for use on both tar and gravel road surfaces.

Providing a firm yet comfortable ride with a fast response time, the Gabriel Technomatic Series and its Gabriel warranty delivers up to its historical South African pedigree and provides for total driving peace of mind.



GABRIEL® TECHNOMATIC™ STRUT CARTRIDGE



GABRIEL® TECHNOMATIC™ STRUT



GABRIEL® TECHNOMATIC™ SPRING SEAT



GABRIEL® TECHNOMATIC™ SHOCK

PRODUCT RANGE

GABRIEL® SAFARI™

The Gabriel Safari Series offers an extensive range of genuine, robust large bore South African oil and gas shock absorbers catering for the demanding requirements of today's light commercial, heavy passenger vehicles, station wagon, South African taxi's, SUV and MPV applications both on and off-road.

Allowing for greater ride control, comfort and ultimately safety, the Gabriel Safari Series and its Gabriel warranty delivers up to its historical South African pedigree and provides for total driving peace of mind.



GABRIEL® SAFARI™ SPRING SEAT SHOCK



GABRIEL® SAFARI™ GAS SHOCK

GABRIEL® SAFARI HDP™

The Gabriel Safari HDP is a genuine robust, technologically advanced, big bore shock absorber specifically designed and manufactured in South Africa to cater for the heavy-duty performance requirements of today's SUV, 4x4 and light commercial applications.

Allowing for greater ride control and increased comfort over other comparative shock absorbers in the market, the Gabriel Safari HDP and its 3 year unlimited kilometer warranty delivers up to its historical Gabriel pedigree and also sets a new standard for performance based shock absorber applications.



GABRIEL® SAFARI HDP™ SHOCK



GABRIEL® SAFARI HDP™ SPRING SEAT SHOCK

PRODUCT RANGE

GABRIEL® FLEET RYDER®

The Gabriel Fleet Ryder Series offers an extensive range of robust and genuine extra large bore South African shock absorbers designed to meet the pressing requirement of today's heavy commercial vehicle and fleet applications.

Providing a firm yet comfortable ride with a fast response time the Gabriel Fleet Ryder Series and its Gabriel warranty delivers up to its historical South African pedigree and provides for total driving peace of mind.



THE GABRIEL® FLEET RYDER® SHOCK

GABRIEL® SUSPENSION TESTERS

Gabriel South Africa in an exclusive partnership with a world leader in equipment testing have developed a unique retail solution that will help you identify worn or faulty shocks absorbers in a quick and professional way. The three models below allow you to choose the best option for your business:

FIXED IN THE FLOOR VERSION

Part No.: 144294



FIXED ON THE FLOOR – FLAT VERSION

Part No.: 144295



MOBILE FLAT VERSION

Part No.: 144296



For more information please go to www.gabriel.co.za, alternatively contact your Gabriel Sales Representative on 0861 242 886.



NEW RELEASES – SHOCKS, STRUTS & CARTRIDGES

This section indicates all our new part numbers released during the course of this year. They are listed and arranged by Vehicle Make, Model, Derivative, Year and Position.

Once a part number is released, you will receive official product bulletins indicating that stock is now available. You then have the ability to simply tick the released part number in the “Released” column.

This function of the catalogue allows you to have a central reference to new part number releases and not rely on keeping product release bulletins.

All new part number releases are also referenced in the vehicle listing of this catalogue.

When a reference is made, the word “NEW” is clearly marked alongside the information.

This allows the reader to refer to this catalogue section to quickly check if the product is released or not.



Make	Model	Derivative	Year	Position	L/R	Part L	Range	Released
Audi	A3	55mm Strut Body. All (8P1) - excluding Quattro, sport susp. & S3.	03-12	Front	↔	70640	Gas Ryder	√
			05-12	Front	↔	70640	Gas Ryder	√
Audi	A4	B8 (excl. Sport Susp. Quattro & S4)	08 on	Front	↔	69119	Gas Ryder	
			08 on	Rear	↔	62057	Gas Ryder	
BMW	5 Series	E60 Series	04-10	Front	L	70814	Gas Ryder	
			04-10	Front	R	70815	Gas Ryder	
			04-10	Rear	↔	69121	Gas Ryder	
BMW	X3	E83 2.5i, 3.0i, 2.0d and 3.0d	04-10	Front	L	70642	Gas Ryder	√
			04-10	Front	R	70643	Gas Ryder	√
Chery	QQ3	0.8, 1.1 (S11)	08 on	Front	L	35955	Technomatic	√
			08 on	Front	R	35956	Technomatic	√
			08 on	Rear	↔	36875	Technomatic	√
Chevrolet	Cruze	(J300) Gen 2	09 on	Front	L	70708	Gas Ryder	
			09 on	Front	R	70709	Gas Ryder	
			09 on	Rear	↔	62052	Gas Ryder	
Chevrolet	Spark	M200, M250	06-10	Front	L	70800	Gas Ryder	
			06-10	Front	R	70801	Gas Ryder	
			06-10	Rear	↔	62089	Gas Ryder	√
Chevrolet	Utility	Montana LDV	11 on	Front	↔	70757	Gas Ryder	
			11 on	Rear	↔	G56278	Safari	√
Daihatsu	Sirion	1.3, 1.5 (Mk II) (Boon)	05-10	Front	↔	70700	Gas Ryder	√
			05-10	Rear	↔	62040	Gas Ryder	√
Daihatsu	Terios II	4X2, 4X4	6/06 - on	Front	↔	70695	Gas Ryder	√
Dodge (Chrysler)	Dodge	Caliber	06 on	Front	L	70711	Gas Ryder	√
			06 on	Front	R	70712	Gas Ryder	√
			06 on	Rear	↔	69117	Gas Ryder	√
Fiat	Punto	Mk II	04-12	Front	↔	70710	Gas Ryder	√
Ford	Focus	Mk III Hatch & Sedan (excl. 2.5 ST & RS)	11 on	Front	L	70771	Gas Ryder	
			11 on	Front	R	70772	Gas Ryder	
			11 on	Rear	↔	62073	Gas Ryder	
Ford	Ranger	4x2 (Std. Susp.) T6	12 on	Front	↔	G56290	Safari	
			12 on	Rear	↔	G56291	Safari	
Ford	Ranger	4x4, 4x2 Hi-Trail (Raised Susp.) T6	12 on	Front	↔	G56276	Safari	
			12 on	Front	↔	GS46013	Safari HDP	
			12 on	Rear	↔	G56277	Safari	√
			12 on	Rear	↔	GS78032	Safari HDP	
GWM	Steed	4X2	08 on	Front	↔	G45904	Technomatic	
			08 on	Rear	↔	G45905	Technomatic	√



Make	Model	Derivative	Year	Position	L/R	Part L	Range	Released
Honda	Civic	Mk VII Hatch	01-05	Front	L	70648	Gas Ryder	✓
			01-05	Front	R	70649	Gas Ryder	✓
Honda	Civic	Mk VII Sedan	01-05	Front	L	70648	Gas Ryder	✓
			01-05	Front	R	70649	Gas Ryder	✓
Honda	CR-V	Mk III	07-12	Front	L	70718	Gas Ryder	
			07-12	Front	R	70719	Gas Ryder	
			07-12	Rear	←→	69120	Gas Ryder	
Honda	Fit	Gen 1 (GD1)	07 on	Front	L	70749	Gas Ryder	✓
			07 on	Front	R	70750	Gas Ryder	✓
Honda	Fit	Gen 1 (GD1)	07 on	Rear	←→	61296	Gas Ryder	
Honda	Jazz	Gen 2 (Fit)	08-13	Front	L	70715	Gas Ryder	
			08-13	Front	R	70716	Gas Ryder	
			08-13	Rear	←→	62058	Gas Ryder	
Hyundai	Accent	MK4	11 on	Front	L	70810	Gas Ryder	
			11 on	Front	R	70811	Gas Ryder	
			11 on	Rear	←→	62093	Gas Ryder	
Hyundai	Elantra	HD Sedan	06-10	Front	L	70793	Gas Ryder	
			06-10	Front	R	70794	Gas Ryder	
			06-10	Rear	←→	62085	Gas Ryder	✓
Hyundai	H1	Minibus, Multicab Bus, Panel Van	09 on	Front	L	70804	Gas Ryder	
			09 on	Front	R	70805	Gas Ryder	
			09 on	Rear	←→	G56294	Safari	
Hyundai	i10	Hatch	08 on	Rear	←→	62053	Gas Ryder	✓
Hyundai	i20	Hatch	09 on	Front	L	70696	Gas Ryder	✓
			09 on	Front	R	70697	Gas Ryder	✓
Hyundai	iX35	4x4, 4x2 (Excl. AWD)	10 on	Front	L	70691	Gas Ryder	✓
			10 on	Front	R	70692	Gas Ryder	✓
			10 on	Rear	←→	62036	Gas Ryder	✓
Isuzu	KB (D-MAX), TF Series	4x2 (Raised Height) (Mk VI)	13 on	Front	←→	G546014	Safari HDP	
			13 on	Rear	←→	G578038	Safari HDP	
Jeep (Chrysler)	Jeep	Wrangler 4x4 (JK)	07-11	Front	←→	G556288	Safari HDP	
			07-11	Rear	←→	G556289	Safari HDP	
Kia	Cerato	Hatch & Sedan	09-13	Front	L	70795	Gas Ryder	
			09-13	Front	R	70796	Gas Ryder	
			09-13	Rear	←→	62086	Gas Ryder	✓
Kia	Picanto	Mk 2 (TA)	11 on	Front	L	70791	Gas Ryder	
			11 on	Front	R	70792	Gas Ryder	
			11 on	Rear	←→	62084	Gas Ryder	✓
Kia	Sportage	4x2 2.0, 2.4 - Gen2 (Excl. AWD)	10 on	Front	L	70691	Gas Ryder	✓
			10 on	Front	R	70692	Gas Ryder	✓

**KIA****NEW RELEASES**

Shocks, Struts & Cartridges

NEW RELEASES

Make	Model	Derivative	Year	Position	L/R	Part L	Range	Released
Land Rover	Freelander	Mk I (1.8, 2.0Td, 2.5 V6)	98-3/07	Rear	L	70616	Gas Ryder	
			98-3/07	Rear	R	70617	Gas Ryder	
Land Rover	Freelander	Mk II (L359)	4/07 on	Rear	L	70677	Gas Ryder	
			4/07 on	Rear	R	70678	Gas Ryder	
Mazda	626	1.8, 2.0 (Mk V), Y5 Sedan	99-03	Front	L	70654	Gas Ryder	√
			99-03	Front	R	70655	Gas Ryder	√
			99-03	Rear	L	70656	Gas Ryder	√
			99-03	Rear	R	70657	Gas Ryder	√
Mazda	BT-50	4x2 Std. Susp.	12 on	Front	←→	G56290	SAFARI	
			12 on	Rear	←→	G56291	SAFARI	
Mazda	BT-50	4x4,4x2 Raised Susp.	12 on	Front	←→	GS46013	SAFARI HDP	
			12 on	Rear	←→	GS78032	SAFARI HDP	
			12 on	Front	←→	G56276	SAFARI	
			12 on	Rear	←→	G56277	SAFARI	√
Mazda	Familia	BJ	00-04	Front	L	70741	Gas Ryder	√
			00-04	Front	R	70742	Gas Ryder	√
			00-04	Rear	L	70743	Gas Ryder	√
			00-04	Rear	R	70744	Gas Ryder	√
Mazda	Familia	BJE	99-00	Front	L	70745	Gas Ryder	√
			99-00	Front	R	70746	Gas Ryder	√
			99-00	Rear	L	70747	Gas Ryder	√
			99-00	Rear	R	70748	Gas Ryder	√
Mazda	Mazda 6	All Excluding MPS (GG/GY)	03 on	Front	L	69107	Gas Ryder	√
			03 on	Front	R	69108	Gas Ryder	√
Mercedes-Benz	C Class	(CLC 203)	00-11	Front	←→	70808	Gas Ryder	
			00-11	Rear	←→	62092	Gas Ryder	
Mercedes-Benz	C Class	C180, C200, C220CDi, C230, C270CDi, C280, C320CDi, C350 (W203)	07 on	Rear	←→	62032	Gas Ryder	√
Mercedes-Benz	E Class	(W212)	09 on	Front	←→	70786	Gas Ryder	
			09 on	Rear	←→	62083	Gas Ryder	
Mercedes-Benz	Sprinter	Panel Van	06 on	Front	←→	70506	Gas Ryder	√
			06 on	Rear	←→	62008	Gas Ryder	√
Mini	Cooper	One, Cooper & Cooper S (R50, R53)	02 on	Front	L	70679	Gas Ryder	√
			02 on	Front	R	70680	Gas Ryder	√
			02 on	Rear	←→	69109	Gas Ryder	√
Nissan	Livina	Incl.. X-Gear & Grand Livina (XJ)	06 on	Rear	←→	62094	Gas Ryder	
Nissan	Micra	Gen 4 (K13)	11 on	Front	L	70806	Gas Ryder	
			11 on	Front	R	70807	Gas Ryder	
			11 on	Rear	←→	62091	Gas Ryder	
Nissan	Qashqai	1.6, 2.0, 1.5DCI (J10, JJ10)	07 on	Front	L	70661	Gas Ryder	√
			07 on	Front	R	70662	Gas Ryder	√



Make	Model	Derivative	Year	Position	L/R	Part L	Range	Released
Opel	Corsa	(D)	07 on	Front	L	70706	Gas Ryder	
			07 on	Front	R	70707	Gas Ryder	
			07 on	Rear	←→	62044	Gas Ryder	√
Peugeot	207	CC 1.6 Sport 2 EU5	06 on	Front	L	70763	Gas Ryder	
			06 on	Front	R	70764	Gas Ryder	
Peugeot	207	Hatch	06 on	Rear	←→	62046	Gas Ryder	√
Renault	Clio	Clio II 1.6 16V Sport	00-06	Front	←→	70809	Gas Ryder	
Renault	Clio	Clio III Hatch	06-13	Front	←→	70682	Gas Ryder	√
			06-13	Rear	←→	62043	Gas Ryder	
Suzuki	Jimny	Gen 3	98 on	Front	←→	G556283	Safari HDP	
			98 on	Rear	←→	G556284	Safari HDP	
Suzuki	Jimny	Gen 3 - SN413 / JA/JB33	98 on	Front	←→	G45901	Technomatic	√
			98 on	Rear	←→	G45902	Technomatic	√
Suzuki	Swift	Gen 3	08 on	Front	L	70689	Gas Ryder	√
			08 on	Front	R	70690	Gas Ryder	√
			08 on	Rear	←→	62055	Gas Ryder	
Suzuki	SX4	4X2	08 on	Front	L	70687	Gas Ryder	
			08 on	Front	R	70688	Gas Ryder	
Toyota	Avensis	Gen 2 (T250)	06-10	Front	L	70701	Gas Ryder	√
			06-10	Front	R	70702	Gas Ryder	√
Toyota	Bubble	(1NZ)	02-07	Front	L	70752	Gas Ryder	√
			02-07	Front	R	70753	Gas Ryder	√
Toyota	Camry	(Gen 5) (SV20)	96-01	Front	L	70727	Gas Ryder	√
			96-01	Front	R	70728	Gas Ryder	√
Toyota	Chaser	Mk II	92-02	Rear	←→	69123	Gas Ryder	√
Toyota	FJ Cruiser	4X4 SUV	11 on	Front	←→	G546012	Safari HDP	
			11 on	Rear	fg	G578037	Safari HDP	
Toyota	Harrier	SXU 10 (Gen 1)	97-03	Front	L	70729	Gas Ryder	√
			97-03	Front	R	70730	Gas Ryder	√
			97-03	Rear	L	70735	Gas Ryder	√
			97-03	Rear	R	70736	Gas Ryder	√
Toyota	Harrier	SXU 15 (Gen 1)	97-03	Rear	L	70737	Gas Ryder	√
			97-03	Rear	R	70738	Gas Ryder	√
Toyota	Harrier	SXU 15 (Gen 1)	97-03	Front	L	70729	Gas Ryder	√
			97-03	Front	L	70730	Gas Ryder	√
Toyota	Ipsum	Avensis Verso (E121) (ACM2)	01-06	Front	L	70754	Gas Ryder	√
			01-06	Front	R	70755	Gas Ryder	√
			01-06	Rear	←→	62061	Gas Ryder	√
Toyota	Ipsum	Picnic (E110) (SM10)	96-01	Front	L	70725	Gas Ryder	√
			96-01	Front	R	70726	Gas Ryder	√
			96-01	Rear	←→	36876	Technomatic	√



Make	Model	Derivative	Year	Position	L/R	Part L	Range	Released
Toyota	Land Cruiser	200	08 on	Front	←→	GS78033	Safari HDP	
			08 on	Rear	←→	GS78034	Safari HDP	
Toyota	Land Cruiser	76SW	07 on	Front	←→	GS78035	Safari HDP	
			07 on	Rear	←→	GS78036	Safari HDP	
Toyota	Prado	J150 (Excl D)	09 on	Front	←→	G56292	Safari	
			09 on	Rear	←→	G56293	Safari	
Toyota	Spaceo	(AE114) (Mk I) (E110)	97-01	Front	L	70731	Gas Ryder	√
			97-01	Front	R	70732	Gas Ryder	√
			97-01	Rear	L	70733	Gas Ryder	√
			97-01	Rear	R	70734	Gas Ryder	√
Toyota	Tercel	Starlet (EL4/NL4)	90-96	Front	L	70739	Gas Ryder	√
			90-96	Front	R	70740	Gas Ryder	√
			90-96	Rear	←→	69122	Gas Ryder	√
Toyota	Vigo	(CGN25) (Rear Not suitable for RSA models)	05 on	Rear	←→	G56281	Safari	√
Toyota	Vigo	(LAN25) (Both Not suitable for RSA models)	05 on	Front	←→	G56282	Safari	√
Toyota	Yaris	Hatch (Gen 3)	11 on	Front	L	70802	Gas Ryder	
			11 on	Front	R	70809	Gas Ryder	
			11 on	Rear	←→	62090	Gas Ryder	
Toyota	Yaris	T1 1.0L,T3 1.3L (Mk II)	05-11	Front	L	70608	Gas Ryder	√
Toyota	Yaris	Vitz	99-05	Front	←→	70751	Gas Ryder	√
			99-05	Rear	←→	62060	Gas Ryder	√
Volkswagen	Amarok	4X2	10 on	Front	←→	70759	Gas Ryder	
			10 on	Rear	←→	G56254	Safari	
Volkswagen	Amarok	4X4, 4X2 Raised	10 on	Front	←→	GS70760	Safari HDP	
			10 on	Rear	←→	G56255	Safari	
			10 on	Rear	←→	GS78031	Safari HDP	
Volkswagen	Crafter	3 ton, 3,5 ton (Excl 4x4 & 5 ton) (LT3)	06 on	Front	←→	70506	Gas Ryder	√
Volkswagen	Jetta	Mk VI (50mm OE Strut Body)	11 on	Front	←→	70774	Gas Ryder	
			11 on	Rear	←→	62018	Gas Ryder	
Volkswagen	Jetta	Mk V 50mm OE Strut Body (Excl. V5 & sport susp.)	06-11	Rear	←→	62018	Gas Ryder	√
			06-11	Rear	←→	62018	Gas Ryder	√
Volkswagen	Jetta	Mk VI (55mm OE Strut Body)	11 on	Front	←→	70775	Gas Ryder	
Volkswagen	Polo	Mk V (Typ 6R) (Excl GTI)	10 on	Front	←→	70714	Gas Ryder	√
Volkswagen	Touran	Typ 1T	04 on	Front	←→	70703	Gas Ryder	
			04 on	Rear	←→	69506	Gas Ryder	
Volvo	S60	Sedan	00-10	Front	←→	70785	Gas Ryder	
			00-10	Rear	←→	62082	Gas Ryder	
			00-10	Rear	←→	62082	Gas Ryder	



VEHICLE LISTING – SHOCKS, STRUTS & CARTRIDGES

The Vehicle Listing section is an easy to use vehicle reference to all Gabriel part numbers, product ranges and technical information according to the specific vehicle make, model, derivative and year: This includes all passenger cars, MPVs, SUVs, 4X4s, Pick-ups, Trucks and Busses.

The product ranges that are highlighted in this section include the Gabriel Gas Ryder™, Safari™, Safari HDP™, Technomatic™, Fleet Ryder® and Heavy Duty Shocks, Struts and Cartridges.

Where a vehicle is referenced to more than one part number/range of Gabriel product, please refer to the section at the beginning of the catalogue (beginning on page 7) where we define the main features, benefits, placement and warranty of each range offered.

The preferred part number/range for each application listing is always listed at the top with preferred alternatives below.

On page 13, all new Gabriel part numbers are listed in alphanumerical order against the vehicle application and derivatives.



A

Model	Derivative	Year	Vehicle Type	Note # (pg 6)	FRONT					REAR					GASLIFT	
					Shock Info	Part #	Side	Range	Status	Shock Info	Part #	Side	Range	Status	Front	Rear
ALFA ROMEO																
33	1.2, 1.3, 1.5, 1.7	83-85								⊕	36855	↔	Technomatic	OBS.		
147	1.6, 2.0 (937)	01-10			†	G51231	↔	Gas Ryder								
155	2.0 (Excl. ⚡)	96-98			†	G35037	↔	Gas Ryder	OBS.	⊗	69919	↔	Gas Ryder			
155	2.5 (Excl. ⚡)	96-98			†	G35038	↔	Gas Ryder	OBS.	⊗	69919	↔	Gas Ryder			
156	2.0 Twin Spark (932) (Excl. ⚡)(VETO116246 Right)	98-06			†	G51217	↔	Gas Ryder		†	G35280	↔	Gas Ryder	OBS.		
156	2.5 V6 (932) ⚡ (VETO116246 Right)	98-06			†	G51231	↔	Gas Ryder		†	G35288	↔	Gas Ryder	OBS.		
156	2.0 Twin Spark (932) (Excl. ⚡)(VETO116245 Right)	97-98			†	G51217	↔	Gas Ryder		†	G35222	↔	Gas Ryder	OBS.		
156	2.5 V6 (932) ⚡ (VETO116245 Right)	97-98			†	G51231	↔	Gas Ryder								
164	2.0, 3.0 (Excl. ⚡)	93-99			†	G35185	↔	Gas Ryder	OBS.	†	G35101	↔	Gas Ryder	OBS.		
166	3.0 V6 Sportronic	98-06			†	G51238	↔	Gas Ryder	OBS.	†	G51239	↔	Gas Ryder	OBS.		
145, 146	2.0 (Hatch & Sedan)	97-01			†	G35160	↔	Gas Ryder	OBS.	⊗	69935	↔	Gas Ryder	OBS.		
Alfasud, Export, Sprint	Excl. Sealed Strut	74-85			†	44858	↔	Technomatic	OBS.	⊕	36849	↔	Technomatic	OBS.		
Alfetta, Giulietta, Super	Incl. (159i, 1600, 1800, GT 1.8, 2000, 2000 GTV)	73-86			±	G45666	↔	Technomatic		†	G45667	↔	Technomatic			4125
Export	1.5, 1.5 GL, 1.5 Veloce	80-85			†	44858	↔	Technomatic	OBS.	⊕	36849	↔	Technomatic	OBS.		
GTV, Spider	2.0 TS	95-05			†	G35216	↔	Gas Ryder	OBS.	⊗	69983	↔	Gas Ryder	OBS.		
GTV, Spider	3.0 V6	95-05			†	G35217	↔	Gas Ryder	OBS.	⊗	69983	↔	Gas Ryder	OBS.		
Other	Incl. Giulia	66-77			⊕	G45122	↔	Technomatic		†	45464	↔	Technomatic	OBS.		
AUDI																
80	B1 (1600 GL, GLS)	75-81			†	44602	↔	Technomatic		⊗	G45715	↔	Technomatic			
100, 200	C2	77-84		14	†	61303	↔	Gas Ryder		⊕	36853	↔	Technomatic			4066
100, 200	Excl. Coupe (C1)	75-77		12	⊕	36826	↔	Technomatic	OBS.	⊕	36854	↔	Technomatic			
100, 200	Excl. Coupe (C1)	72-74		12	⊕	36844	↔	Technomatic	OBS.	⊕	36854	↔	Technomatic			
400, 500	C3, C4	83-94		14	†	61303	↔	Gas Ryder		†	69072	↔	Gas Ryder			4081
A3	50mm Strut Body. Sportback (8PA) Excl. Quattro, Sport Susp. & S3.	05-12			†	70546	↔	Gas Ryder		⊕	69507	↔	Gas Ryder			
A3	55mm Strut Body. Sportback (8PA) Excl. Quattro, Sport Susp. & S3.	05-12			†	70640	↔	Gas Ryder	NEW	⊕	69507	↔	Gas Ryder			
A3	50mm Strut Body. All (8P1) – Excl. Quattro, Sport Susp. & S3.	03-12			†	70546	↔	Gas Ryder		⊕	69507	↔	Gas Ryder			
A3	55mm Strut Body. All (8P1) – Excl. Quattro, Sport Susp. & S3.	03-12			†	70640	↔	Gas Ryder	NEW	⊕	69507	↔	Gas Ryder			
A3	Excl. S3 (8L1)	98-03			†	55872	↔	Gas Ryder	NEW	⊕	61262	↔	Gas Ryder			

VEHICLE LISTING

Shocks, Struts, Gaslifts & Cartridges

AUDI



A

Model	Derivative	Year	Vehicle Type	Note # (pg 6)	FRONT					REAR					GASLIFT	
					Shock Info	Part #	Side	Range	Status	Shock Info	Part #	Side	Range	Status	Front	Rear
AUDI																
A4	B8 (Excl. Sport Susp., Quattro & S4)	08 on			†	69119	↔	Gas Ryder	NEW	⊖	62057	↔	Gas Ryder	NEW		
A4	Excl. Sport Susp. (B7)	05-08			†	69101	↔	Gas Ryder		⊖	62024	↔	Gas Ryder			
A4	Sport Susp. Incl. Avant & Quattro(Exl All Road, S4 & RS4) B7 model	05-08								⊖	62003	↔	Gas Ryder			
A4	Excl. Sport Susp. (B6)	01-05			†	69101	↔	Gas Ryder		⊖	61298	↔	Gas Ryder			
A4	Avant (8D5)	96-99														4325
A4	1.8, 2.4, 2.6, 2.8 Excl. Quattro (B5)	94-01			†	69087	↔	Gas Ryder		†	G51023	↔	Gas Ryder		4321	4284
A4	Quattro Excl. Sport Susp. (B5)	94-01			†	69087	↔	Gas Ryder								
A4	Quattro Sport Susp. (B5)	94-01			†	G51099	↔	Gas Ryder	OBS.							
A6	Avant (8D5)	00 on														4326
A6	Excl. & Quattro (C5)	97-04			†	G51101	↔	Gas Ryder		⊖	69946	↔	Gas Ryder		4324	
A6	Quattro (C5)	97-04			†	G51101	↔	Gas Ryder							4324	
A6	Incl. Avant. Excl. Quattro (C4)	94-97		14	†	61303	↔	Gas Ryder		†	69072	↔	Gas Ryder			4323
AUSTIN, MORRIS																
Marina	1300, 1750, 2600	73-79								⊖	42447	↔	Technomatic	OBS.		
Mini	Excl. Hydrolastic Susp.	59-85			⊖	19021	↔	Technomatic		⊖	19022	↔	Technomatic			
Mini	Incl. Cooper	59-80			⊖	19021	↔	Technomatic		⊖	19022	↔	Technomatic			
Mini	Incl. Mk III	61-79			⊖	19021	↔	Technomatic		⊖	19022	↔	Technomatic			
BEDFORD																
4x4	Truck	70-80	g		⊖	76015	↔	Fleet Ryder		⊖	76015	↔	Fleet Ryder			
CF Series	Van, Truck	70-84			†	83233	↔	Heavy Duty	OBS.	⊖	G56102	↔	Safari			
ELR4, ELR 6, ELR A, ELR 8	Truck	75-79	g		⊖	76015	↔	Fleet Ryder								
J2-4	Truck	65 on	g		†	G56119	↔	Safari		⊖	G56116	↔	Safari			
J5-6	Truck	65 on	g		†	G56119	↔	Safari		⊖	G56126	↔	Safari			
KE, KG, KH All	Truck	64 on	g		⊖	76015	↔	Fleet Ryder		⊖	76015	↔	Fleet Ryder			
					⊖	G56126	↔	Safari		⊖	G56126	↔	Safari			
KM All	Truck	72 on	g		⊖	76042	↔	Fleet Ryder								
MFR	Truck	72 on	g		⊖	G56174	↔	Safari		⊖	G56174	↔	Safari			
MFR	Truck	67-71	g		⊖	76015	↔	Fleet Ryder		⊖	76015	↔	Fleet Ryder			
					⊖	G56126	↔	Safari		⊖	G56126	↔	Safari			
VAL	Bus	66 on			⊖	76015	↔	Fleet Ryder								
					⊖	G56126	↔	Safari								
VAM	Bus	76 on			†	76009	↔	Fleet Ryder								
VAM	Bus	73-75			⊖	G56174	↔	Safari		⊖	G56174	↔	Safari			
YRT	Bus	19..			⊖	76103	↔	Fleet Ryder								

Status: Part numbers marked as OBS. are obsolete or in the process of being phased out
 NEW – please refer to page 13 for more details | E&OE





BMW

VEHICLE LISTING

Shocks, Struts, Gaslifts & Cartridges

B

Model	Derivative	Year	Vehicle Type	Note # (pg 6)	FRONT					REAR					GASLIFT	
					Shock Info	Part #	Side	Range	Status	Shock Info	Part #	Side	Range	Status	Front	Rear
BMW																
1 Series	E82 Coupe (Excl. Sport Susp. & 135i)	08 on			†	70577	L	Gas Ryder		†	69102	↔	Gas Ryder			
					†	70578	R	Gas Ryder		†	69102	↔	Gas Ryder			
1 Series	E88 Cabriolet (Excl. Sport Susp. & 135i)	08 on			†	70577	L	Gas Ryder		†	69102	↔	Gas Ryder			
					†	70578	R	Gas Ryder		†	69102	↔	Gas Ryder			
1 Series	E81 3-Door (Excl. Sport Susp. & 135i)	07-11			†	70577	L	Gas Ryder		†	69102	↔	Gas Ryder			
					†	70578	R	Gas Ryder		†	69102	↔	Gas Ryder			
1 Series	E87 5-Door (Excl. Sport Susp. & 135i)	04-11			†	70577	L	Gas Ryder		†	69102	↔	Gas Ryder			
					†	70578	R	Gas Ryder		†	69102	↔	Gas Ryder			
2 Series	1502, 2002 Ti Lux (E10)	66-77			†	G44706	↔	Gas Ryder	OBS.	⊕	36857	↔	Technomatic			
2 Series	1802, 2002 (E10)	68-75			±	G45532	↔	Technomatic		⊕	G45861	↔	Technomatic			
3 Series	E36 series Imported 320i, 325i, 325td (Long Stud) (Excl. M-series)	91-92			†	70587	L	Gas Ryder		⊕	61248	↔	Gas Ryder		4270 4269	
					†	70588	R	Gas Ryder		⊕	61248	↔	Gas Ryder			
3 Series	E36 Cabriolet	93-99			†	55834	L	Gas Ryder		⊕	61248	↔	Gas Ryder			
					†	55835	R	Gas Ryder		⊕	61248	↔	Gas Ryder			
3 Series	E36 series (Excl. M3)	91-99			†	55834	L	Gas Ryder		⊕	61248	↔	Gas Ryder		4270 4269	
					†	55835	R	Gas Ryder		⊕	61248	↔	Gas Ryder			
3 Series	E36 series (imported 4 cyl. models)	91-99			†	EG35040	L	Gas Ryder	OBS.	⊕	61248	↔	Gas Ryder		4270 4269	
					†	EG35041	R	Gas Ryder	OBS.	⊕	61248	↔	Gas Ryder			
3 Series	E36 series (imported 6 cyl. models)	91-99			†	EG35042	L	Gas Ryder	OBS.	⊕	61248	↔	Gas Ryder		4270 4269	
					†	EG35043	R	Gas Ryder	OBS.	⊕	61248	↔	Gas Ryder			
3 Series	E46 series (Excl. M3, ☼ + Touring) one pin at the bottom strut mounting	99-05		24	†	70508	L	Gas Ryder		⊕	61248	↔	Gas Ryder			
					†	70509	R	Gas Ryder		⊕	61248	↔	Gas Ryder			
3 Series	E90 series (Excl. M3, ☼)	05-12			†	70577	L	Gas Ryder		†	69102	↔	Gas Ryder			
					†	70578	R	Gas Ryder		†	69102	↔	Gas Ryder			
3 Series	E91 series	05-12								†	69102	↔	Gas Ryder			
3 Series	E92 series	07-14			†	70789	L	Gas Ryder		†	69102	↔	Gas Ryder			
					†	70790	R	Gas Ryder		†	69102	↔	Gas Ryder			
3 Series	E93 series	07-14			†	70577	L	Gas Ryder		†	69102	↔	Gas Ryder			
					†	70578	R	Gas Ryder		†	69102	↔	Gas Ryder			

VEHICLE LISTING

Shocks, Struts, Gaslifts & Cartridges

BMW



B

Model	Derivative	Year	Vehicle Type	Note # (pg 6)	FRONT					REAR					GASLIFT	
					Shock Info	Part #	Side	Range	Status	Shock Info	Part #	Side	Range	Status	Front	Rear
BMW (CONT...)																
5 Series	E60 Series	04-10			†	70814	L	Gas Ryder	NEW	⊖	69121	↔	Gas Ryder	NEW		
					†	70815	R	Gas Ryder	NEW	⊖	69121	↔	Gas Ryder	NEW		
5 Series	E39 Series (520i, 523i, 525i, 525TDS, 528i, 530i, 530D) (Excl. †)	96-04			†	G35228	↔	Gas Ryder		†	G51216	↔	Gas Ryder			
5 Series	E39 Series (535i, 540i) (Excl. †)	96-04			†	G35227	↔	Gas Ryder		†	G51216	↔	Gas Ryder			
5 Series	E34 Series (Excl. ⓈI, M5)	89-96		14	†	61302	↔	Gas Ryder		†	62353	↔	Gas Ryder			
5 Series	E28 Series (Excl. M5)	85-89		14	†	61914	↔	Gas Ryder		†	62352	↔	Gas Ryder			
5 Series	E60 series	04-10			†	70815	L	Gas Ryder	NEW	⊖	69121	↔	Gas Ryder	NEW		
					†	70814	R	Gas Ryder	NEW	⊖	69121	↔	Gas Ryder	NEW		
5 Series	E12 Series	76-85		18	†	44601	↔	Gas Ryder		†	51309	↔	Technomatic			
					†	44601	↔	Technomatic		†	51309	↔	Technomatic			
5 Series	E12 Series	74-76			†	44601	↔	Gas Ryder		†	51308	↔	Technomatic	OBS.		
					†	44601	↔	Technomatic		†	51308	↔	Technomatic	OBS.		
7 Series	E32 Series	87-94			†	61302	↔	Gas Ryder							4060	
7 Series	E23 Series (Excl. ⓈI)	77-86		18	†	61906	↔	Gas Ryder	OBS.	†	62351	↔	Gas Ryder			4061
X3	E83 2.5i, 3.0i, 2.0d and 3.0d	04-10		F	†	70642	L	Gas Ryder	NEW	⊖	62021	↔	Gas Ryder			
					†	70643	R	Gas Ryder	NEW	⊖	62021	↔	Gas Ryder			
X5	E53 3.0i, 3.0d, 4.4iV8, 4.8 V8 4x4	01-07			†	70542	L	Gas Ryder		⊖	61292	↔	Gas Ryder			
					†	70543	R	Gas Ryder		⊖	61292	↔	Gas Ryder			
Z3	E36/4 (E36/7 roadster) (E36/8 coupé)	98-03			†	EG35046	L	Gas Ryder		⊖	69948	↔	Gas Ryder			
					†	EG35047	R	Gas Ryder		⊖	69948	↔	Gas Ryder			
BUSSING																
14, 15 AK	Truck	19...	g							⊗	76019	↔	Fleet Ryder			
16L, LBL, LU, UK	Truck	19...	g		⊗	76033	↔	Fleet Ryder								
19L, BBL	Truck	19...	g		†	76006	↔	Fleet Ryder								
22L, BLL (Tag axle)	Truck	19...	g							†	76034	↔	Fleet Ryder			
CAM																
Inyathi	Minibus	07 on			⊖	G56244	↔	Safari		⊗	G56245	↔	Safari			
CASSPIR																
Casspir	Armoured Vehicle	19...	g		⊗	77007	↔	Fleet Ryder		⊗	77008	↔	Fleet Ryder			
CHANA																
Star	Bakkie, Panel van, Minibus (Incl. Maxi Star)	06 on			†	35953	L	Technomatic		⊗	G45896	↔	Technomatic			
					†	35954	R	Technomatic		⊗	G45896	↔	Technomatic			



C

Model	Derivative	Year	Vehicle Type	Note # (pg 6)	FRONT					REAR					GASLIFT	
					Shock Info	Part #	Side	Range	Status	Shock Info	Part #	Side	Range	Status	Front	Rear
CHERY																
QQ3	0.8, 1.1 (S11)	08 on			↕	35955	L	Technomatic	NEW	⊗	36875	↔	Technomatic	NEW		
					↕	35956	R	Technomatic	NEW	⊗	36875	↔	Technomatic	NEW		
CHEVROLET																
2500, 3800, 4100	2.5, 3.8, & 4.1 Estate	75-78			±	G45212	↔	Technomatic		⊕	G45399	↔	Technomatic			
2500, 3800, 4100	2.5, 3.8, & 4.1 Sedan	72-78			±	G45212	↔	Technomatic		⊕	G45489	↔	Technomatic			
Aveo	T200 (Kalos)	02 on			↕	35941	L	Technomatic		⊕	36866	↔	Technomatic			
					↕	35942	R	Technomatic		⊕	36866	↔	Technomatic			
Aveo	T200 (Kalos) Hatch	02 on			↕	35941	L	Technomatic		⊕	36866	↔	Technomatic			
					↕	35942	R	Technomatic		⊕	36866	↔	Technomatic			
Blazer 4x4	S10 (Excl.)	83-95			⊗	G63423	↔	Gas Ryder	OBS.	⊗	G63422	↔	Gas Ryder	OBS.		
C Series	C10, C20	74-83			⊗	G56106	↔	Safari		⊗	G56147	↔	Safari	OBS.		
C Series	C30	74-83			⊗	G56106	↔	Safari		⊗	G56148	↔	Safari	OBS.		
C Series	C10, C20	63-73			⊗	G56106	↔	Safari		⊗	G56107	↔	Safari			
C Series	C30	63-73			⊗	G56106	↔	Safari		⊗	G56126	↔	Safari			
Chevelle	Mk I	64-70			±	G45466	↔	Technomatic		⊗	81514	↔	Heavy Duty	OBS.		
Cruze	(J 300) Gen 2	09 on			↕	70708	L	Gas Ryder	NEW	⊕	62052	↔	Gas Ryder	NEW		
					↕	70709	R	Gas Ryder	NEW	⊕	62052	↔	Gas Ryder	NEW		
El Camino	Incl. El Toro	72-78			±	G45532	↔	Technomatic		⊗	G45534	↔	Technomatic			
El Camino	Incl. El Toro	71-72			±	G45255	↔	Technomatic		⊕	G56118	↔	Safari			
					±	G45255	↔	Technomatic		⊕	G45533	↔	Technomatic			
Firenza	Coupe	71-78		2	⊗	G45447	↔	Technomatic		⊕	G45533	↔	Technomatic			
K Series 4x4	K10, K20, K25	74-83			⊗	G56149	↔	Safari	OBS.	⊗	G56147	↔	Safari	OBS.		
Lumina	APV	90-95			↕	G55514	↔	Gas Ryder	OBS.	⊕	G63914	↔	Gas Ryder	OBS.		
Lumina	Van	90-95			↕	G55514	↔	Gas Ryder	OBS.	⊕	G63914	↔	Gas Ryder	OBS.		
LUV	Faster	73-78			⊕	G45535	↔	Technomatic		⊗	G56116	↔	Safari			
					⊕	G45535	↔	Technomatic		⊗	G45006	↔	Technomatic			
Nomad	LDV	75-78			⊗	G45447	↔	Technomatic								
Optra (Lacetti)	1.6 & 1.8 (Mk I)	02 on			↕	70563	L	Gas Ryder		↕	70566	L	Gas Ryder			
					↕	70564	R	Gas Ryder		↕	70565	R	Gas Ryder			
Spark	M300 (Excl. Lite)	10 on			↕	70596	L	Gas Ryder		⊕	G45897	↔	Technomatic			
					↕	70597	R	Gas Ryder		⊕	G45897	↔	Technomatic			
Spark	M200, M250	06-10			↕	70800	L	Gas Ryder	NEW	⊗	62089	↔	Gas Ryder	NEW		
					↕	70801	R	Gas Ryder	NEW	⊗	62089	↔	Gas Ryder	NEW		
Spark (Matiz)	Spark (M100, M150)	03-05			↕	G35295	L	Gas Ryder		⊗	69431	↔	Gas Ryder			
					↕	G35300	R	Gas Ryder		⊗	69431	↔	Gas Ryder			
Utility	Montana LDV	11 on			↕	70757	↔	Gas Ryder	NEW	⊕	G56278	↔	Safari	NEW		



C

Model	Derivative	Year	Vehicle Type	Note # (pg 6)	FRONT					REAR					GASLIFT	
					Shock Info	Part #	Side	Range	Status	Shock Info	Part #	Side	Range	Status	Front	Rear
CHEVROLET / OPEL																
Ascona, Chevaiv	(Short Strut) (C)	84-86			/	44933	↔	Technomatic	OBS.	⊥	G45839	↔	Technomatic			4080
Ascona, Chevaiv	(C)	82-85			/	44615	↔	Technomatic		⊥	G45839	↔	Technomatic			4080
Ascona, Chevaiv	B, (Mk I Cavalier)	76-82			⊥	45702	↔	Technomatic	OBS.	⊥	G45489	↔	Technomatic			
					⊥	81297	↔	Heavy Duty	OBS.	⊥	G45489	↔	Technomatic			
CHRYSLER																
Jeep	Patriot (MK)	07 on			/	70711	L	Gas Ryder	NEW	/	69117	↔	Gas Ryder	NEW		
					/	70712	R	Gas Ryder	NEW	/	69117	↔	Gas Ryder	NEW		
Jeep	Wrangler 4x4 (JK)	07-11			⊥	GS56288	↔	Safari HDP	NEW	⊥	GS56289	↔	Safari HDP	NEW		
Jeep	Cherokee (KJ) 2.5D, 2.8D, 3.7	01-07			/	GS46011	↔	Safari HDP		⊥	GS56267	↔	Safari HDP			
					/	G56262	↔	Safari		⊥	G56263	↔	Safari			
Jeep	Wrangler 4x4 (TJ)	96-06			⊥	GS78025	↔	Safari HDP		⊥	GS78026	↔	Safari HDP			
					⊥	G63721	↔	Gas Ryder		⊥	G63722	↔	Gas Ryder			
Jeep	Cherokee (XJ)	96-01			⊥	GS78025	↔	Safari HDP		⊥	GS56261	↔	Safari HDP			
Jeep	Grand Cherokee (ZJ)	96-99			⊥	G63424	↔	Gas Ryder	OBS.	⊥	G63683	↔	Gas Ryder	OBS.		
Jeep	Grand Cherokee (ZJ)	93-95			⊥	G63424	↔	Gas Ryder	OBS.	⊥	G63626	↔	Gas Ryder	OBS.		
Jeep	CJ Series (Willys) (CJ5, CJ6, CJ7)	54-86			⊥	G56102	↔	Safari		⊥	G56116	↔	Safari			
					⊥	G45051	↔	Technomatic		⊥	G45006	↔	Technomatic			
Neon	11	00-06			/	55898	↔	Gas Ryder	OBS.	/	55899	L	Gas Ryder	OBS.		
					/	55898	↔	Gas Ryder	OBS.	/	55900	R	Gas Ryder	OBS.		
Neon	1	97-99			/	G55679	↔	Gas Ryder	OBS.	/	G55680	↔	Gas Ryder	OBS.		
PT Cruiser	Incl. convertible	00-10			/	55911	↔	Gas Ryder	OBS.							
Valiant	Incl. Dodge SE, Chrysler L	60-81			⊥	81469	↔	Technomatic	OBS.	⊥	45172	↔	Technomatic	OBS.		
Valiant	Rustler	72-78			⊥	81469	↔	Technomatic	OBS.	⊥	45172	↔	Technomatic	OBS.		
Voyager	Gen III (Incl. Grand Voyager) (Excl.)	01-07								⊥	G63690	↔	Gas Ryder			
Voyager	Gen II (Incl. Grand Voyager) (Excl.)	95-00			/	G55697	↔	Gas Ryder		⊥	G63690	↔	Gas Ryder			
Voyager	Gen I (Incl. Grand Voyager) (Excl.)	86-95								⊥	G63690	↔	Gas Ryder			
CITROEN																
Xsara	Mk II (Incl. Picasso Excl. VTS) (1.4, 1.6, 2.0, 2.0HDI)	00-07								⊥	69965	↔	Gas Ryder			
DAEWOO																
Cielo	Nexia	95-98		14	/	61909	↔	Gas Ryder		⊥	G45874	↔	Technomatic			
					/	44607	↔	Technomatic		⊥	G45874	↔	Technomatic			
Espero	Aranos	95-99		14	/	61909	↔	Gas Ryder		⊥	G45874	↔	Technomatic			
					/	44607	↔	Technomatic		⊥	G45874	↔	Technomatic			
Lanos	Sens	97-03		14	/	61909	↔	Gas Ryder		⊥	G45874	↔	Technomatic			
					/	44607	↔	Technomatic		⊥	G45874	↔	Technomatic			
Matiz	Spark (M100)	99-03			/	G35295	L	Gas Ryder		⊥	69431	↔	Gas Ryder			
					/	G35300	R	Gas Ryder		⊥	69431	↔	Gas Ryder			



D

Model	Derivative	Year	Vehicle Type	Note # (pg 6)	FRONT					REAR					GASLIFT	
					Shock Info	Part #	Side	Range	Status	Shock Info	Part #	Side	Range	Status	Front	Rear
DAF																
AT1900	Truck	19...	g		⊗	76007	↔	Fleet Ryder		⊗	76007	↔	Fleet Ryder			
FA2200, F2200	Truck	72-80	g		⊖	76035	↔	Fleet Ryder		†	76034	↔	Fleet Ryder			
FT 2200 DU	Truck	72-80	g		†	77004	↔	Fleet Ryder								
FTT 2800 DKTD	Truck	75-82	g		⊖	76035	↔	Fleet Ryder		†	76020	↔	Fleet Ryder			
DAIHATSU																
Charade	Incl. Coupe (G11)	83-87								⊖	G45861	↔	Technomatic			
Feroza	F300 (Rocky)	97-99			⊖	G63612	↔	Gas Ryder	OBS.	⊖	G63508	↔	Gas Ryder	OBS.		
Grand Move	Pyzar	97-01			†	70534	L	Gas Ryder	OBS.	†	70532	L	Gas Ryder	OBS.		
					†	70535	R	Gas Ryder	OBS.	†	70533	R	Gas Ryder	OBS.		
Rocky	Mk II	97-02			⊖	G63935	↔	Gas Ryder	OBS.	⊖	G63936	↔	Gas Ryder	OBS.		
Sirion	1.3, 1.5 (Mk II) (Boon)	05-10			†	70700	↔	Gas Ryder	NEW	⊗	62040	↔	Gas Ryder	NEW		
Terios II	4x2, 4x4	6/06 – on			⊗	70695	↔	Gas Ryder	NEW	⊗	62038	↔	Gas Ryder			
DODGE (CHRYSLER)																
Dodge	Caliber	06 on			†	70711	L	Gas Ryder	NEW	†	69117	↔	Gas Ryder	NEW		
					†	70712	R	Gas Ryder	NEW	†	69117	↔	Gas Ryder	NEW		
Dodge Colt	1600, 2000	72-77			†	44502	↔	Technomatic	OBS.	⊗	G45538	↔	Technomatic	OBS.		
Dodge Husky	LDV	74-78		3	†	44529	↔	Technomatic	OBS.	⊗	G45006	↔	Technomatic			
ERF																
E6 (Air Susp.)	Truck	19...			†	76006		Fleet Ryder								
Erf	Truck	19...			⊖	76035	↔	Fleet Ryder								
Trailblazer	Trailblazer Bus	19...			⊖	77011	↔	Fleet Ryder	OBS.							
Trailblazer	Trailblazer Bus	19...		32	⊖	76103	↔	Fleet Ryder		⊖	76103	↔	Fleet Ryder			
FIAT																
124	124 Special, 124 ST 1600	69-77			⊖	42155	↔	Technomatic	OBS.	⊖	45436	↔	Technomatic	OBS.		
124	Station Wagon	69-77			⊖	45410	↔	Technomatic	OBS.	⊗	G45006	↔	Technomatic			
125	Sedan	69-75			⊖	42282	↔	Technomatic	OBS.	⊖	G45423	↔	Technomatic			
131	Mirafiori, Superstrada, Rally	79-81			†	35868	↔	Technomatic	OBS.	⊖	45436	↔	Technomatic	OBS.		
132	1.6GL, 1.6 GLS, 1.8 GLS (Argenta)	79-81			†	35868	↔	Technomatic	OBS.	⊗	G45810	↔	Technomatic			
132	1.6GL, 1.6 GLS, 1.8 GLS (Argenta)	75-81			⊖	42282	↔	Technomatic	OBS.							
133	Seat 133	77-78			†	G44705	↔	Gas Ryder	OBS.	⊖	45436	↔	Technomatic	OBS.		
					†	44224	↔	Technomatic	OBS.	⊖	82608	↔	Heavy Duty	OBS.		
128	LDV	73-84			†	44221	↔	Technomatic	OBS.	†	44222	↔	Technomatic	OBS.		
128	1.1, 1.3 & Rally	71-81			†	44221	↔	Technomatic	OBS.	†	44222	↔	Technomatic	OBS.		
130NR	Truck	77-83	g		⊗	76017	↔	Fleet Ryder								
619T1	Truck	69-80	g		⊗	77022	↔	Fleet Ryder								
682 SWB	Truck	19...	g		⊗	76017	↔	Fleet Ryder								
684N, 684T	Truck	71-81	g		⊗	76017	↔	Fleet Ryder								

VEHICLE LISTING

Shocks, Struts, Gaslifts & Cartridges

FIAT



F

Model	Derivative	Year	Vehicle Type	Note # (pg 6)	FRONT					REAR					GASLIFT	
					Shock Info	Part #	Side	Range	Status	Shock Info	Part #	Side	Range	Status	Front	Rear
FIAT (CONT...)																
Croma	Excl. 2.0 Turbo	85-96			†	G35013	↔	Gas Ryder	OBS.							
Palio	Expresso Panel van	02 on			†	70583	↔	Gas Ryder		⊖	62005	↔	Gas Ryder			
Palio	Type 2H	02 on			†	70583	↔	Gas Ryder		⊖	62005	↔	Gas Ryder			
Palio	Weekend (Type 2G)	02 on								⊗	69919	↔	Gas Ryder			4328
Palio	Type 1X	00-01			†	G35214	↔	Gas Ryder		⊖	61270	↔	Gas Ryder			4327
Palio	Weekend (Type PY)	00-01			†	G35214	↔	Gas Ryder		⊗	69919	↔	Gas Ryder			
Punto	Mk II	04-12			†	70710	↔	Gas Ryder	NEW							
Seicento	600	99-03			†	G35279	↔	Gas Ryder		⊗	69921	↔	Gas Ryder			
Siena	Siena II	02 on								⊖	61270	↔	Gas Ryder			
Siena	Type 2A	00-02			†	G35214	↔	Gas Ryder		⊖	61270	↔	Gas Ryder			
Strada	3/4 ton LDV (Mk II)	05 on			†	70594	↔	Gas Ryder		⊖	G56258	↔	Safari			
Ulysse	Eurovan	99-03			†	G35150	↔	Gas Ryder	OBS.	⊗	69914	↔	Gas Ryder	OBS.		
Uno	Incl. Turbo (Series 2)	90-06			†	55854	↔	Gas Ryder		⊖	61241	↔	Gas Ryder			4063
Uno	Panel van (Series 2)	90-06			†	55854	↔	Gas Ryder		⊖	61241	↔	Gas Ryder			
X 1/9	1.5 (with serviceable struts)	81-85			†	G44733	↔	Gas Ryder	OBS.							
X 1/9	1.3 (with serviceable struts)	77-80			†	G44733	↔	Gas Ryder	OBS.	†	G44733	↔	Gas Ryder	OBS.		
FORD																
Bantam	1.3	06 on			†	70510	↔	Gas Ryder		⊗	G45878	↔	Technomatic			
Bantam	1.6	06 on			†	70510	↔	Gas Ryder		⊗	G45878	↔	Technomatic			
Bantam	1.3	03-06			†	70510	↔	Gas Ryder		⊗	G45878	↔	Technomatic			
Bantam	1.6	03-06			†	70510	↔	Gas Ryder		⊗	G45878	↔	Technomatic			
Bantam	1.8D	02			†	70510	↔	Gas Ryder		⊗	G45878	↔	Technomatic			
Bantam	1.3	94-02			†	35927	↔	Technomatic		⊗	G45878	↔	Technomatic			
Bantam	1.6	94-02			†	35927	↔	Technomatic		⊗	G45878	↔	Technomatic			
Bantam	1.4	86-94			†	35844	↔	Technomatic		⊗	G45875	↔	Technomatic			
Bantam	1.6	86-94			†	35844	↔	Technomatic		⊗	G45875	↔	Technomatic			
Bantam	1.3	83-86			†	35816	↔	Technomatic		⊗	G45875	↔	Technomatic			
Bantam	1.6	83-86			†	35816	↔	Technomatic		⊗	G45875	↔	Technomatic			
Capri	Mk I	69-73			†	44516	↔	Technomatic		⊖	36854	↔	Technomatic			
Cargo	0608, 0808	82-86	g		†	76034	↔	Fleet Ryder		⊗	76042	↔	Fleet Ryder			
Cargo	0912, 1112, 1113	82-86	g		†	76034	↔	Fleet Ryder		⊗	76042	↔	Fleet Ryder			
Cargo	1312, 1313	82-86	g		†	76034	↔	Fleet Ryder		⊗	76042	↔	Fleet Ryder			
Cargo	1317, 1517	82-86	g		†	76034	↔	Fleet Ryder		⊗	76042	↔	Fleet Ryder			
Cargo	2217	82-86	g		†	76034	↔	Fleet Ryder		⊗	76042	↔	Fleet Ryder			
Cargo	1212, 1213	82-85	g		†	76034	↔	Fleet Ryder		⊗	76042	↔	Fleet Ryder			



F

Model	Derivative	Year	Vehicle Type	Note # (pg 6)	FRONT					REAR					GASLIFT	
					Shock Info	Part #	Side	Range	Status	Shock Info	Part #	Side	Range	Status	Front	Rear
FORD (CONT...)																
Corsair	1.6, 2.0	66-69								⊕	36854	↔	Technomatic			
Corsair	1.6	64-66			/	44559	↔	Technomatic	OBS.	⊕	36854	↔	Technomatic			
Cortina	Mk V LDV	83-86			⊕	G56160	↔	Safari		⊖	G56159	↔	Safari			
Cortina	Mk V Estate	80-83			⊕	G45837	↔	Technomatic		⊖	G45520	↔	Technomatic			
Cortina	Mk V Sedan	80-83		14	⊕	G45837	↔	Technomatic		⊕	G45838	↔	Technomatic			
Cortina	Mk V LDV	80-82			⊕	G56160	↔	Safari		⊖	G56156	↔	Safari			
Cortina	Mk IV LDV	78-80			⊕	G56153	↔	Safari		⊖	G56156	↔	Safari			
Cortina	Mk IV	77-80			⊕	G45503	↔	Technomatic		⊖	G45520	↔	Technomatic			
Cortina	Mk III, IV	71-78		20	⊕	G56153	↔	Safari		⊖	G45418	↔	Technomatic			
Cortina	Mk III, IV LDV	71-78		20	⊕	G56153	↔	Safari		⊖	G56103	↔	Safari			
Cortina	Mk III	71-77			⊕	G45503	↔	Technomatic		⊖	G45520	↔	Technomatic			
Cortina	Mk II	68-70			/	44514	↔	Technomatic	OBS.	⊕	36854	↔	Technomatic			
Cortina	Mk II	67								⊕	36854	↔	Technomatic			
Cortina	Mk I	64-66			/	44559	↔	Technomatic	OBS.	⊕	36854	↔	Technomatic			
Courier	4x2 (Std. Susp.)	86-06				⊕	G56173	↔	Safari		⊖	G56116	↔	Safari		
Courier	4x4, 4x2 Hi-Trail (raised Susp.)	86-06				⊕	G556233	↔	Safari HDP		⊖	G578014	↔	Safari HDP		
D1210, D1211	Truck	78-82	g		+	76009	↔	Fleet Ryder		⊖	76007	↔	Fleet Ryder			
D1311, D1414	Truck	72-82	g		+	76009	↔	Fleet Ryder		⊖	76007	↔	Fleet Ryder			
DA 2114	Truck	74-82	g		+	76009	↔	Fleet Ryder		⊖	76007	↔	Fleet Ryder			
DO 607, DO 807	Truck	73-82	g		+	76009	↔	Fleet Ryder		⊖	76007	↔	Fleet Ryder			
DO 910, D1010	Truck	71-82	g		+	76009	↔	Fleet Ryder		⊖	76007	↔	Fleet Ryder			
DT 2014	Truck	72-82	g		+	76009	↔	Fleet Ryder		⊖	76007	↔	Fleet Ryder			
Escort	Mk V, VI, VII	95-99			/	G35146	↔	Gas Ryder		⊖	G51082	↔	Gas Ryder			
Escort	Mk V, VI, VII	95-99			/	G35146	↔	Gas Ryder		⊖	69423	↔	Gas Ryder			4272
Escort	Mk III Fwd L, GL, GLE	81-86				/	35816	↔	Technomatic		/	55802	↔	Gas Ryder		4063
Escort	Mk III Fwd XR3, Sport	81-86				/	35816	↔	Technomatic		/	55802	↔	Gas Ryder		4064
Escort	Mk II	75-81		17	/	44505	↔	Technomatic		⊕	G45742	↔	Technomatic			
Escort	Mk I, II	74-81			/	44505	↔	Technomatic		⊖	G45413	↔	Technomatic			
Escort	Mk I 1100, 1300	70-75			/	44505	↔	Technomatic		⊖	G45413	↔	Technomatic			
Escort	Mk I 1600, GT	70-75			/	44516	↔	Technomatic		⊖	G45413	↔	Technomatic			
Escort	Mk I	68-73			/	44505	↔	Technomatic		⊖	G45413	↔	Technomatic			

VEHICLE LISTING

Shocks, Struts, Gaslifts & Cartridges

FORD



F

Model	Derivative	Year	Vehicle Type	Note # (pg 6)	FRONT					REAR					GASLIFT	
					Shock Info	Part #	Side	Range	Status	Shock Info	Part #	Side	Range	Status	Front	Rear
FORD (CONT...)																
Explorer	Mk II	95-01			±	G63678	↔	Gas Ryder	OBS.	⊖	G63679	↔	Gas Ryder	OBS.		
F Series	F150 4x4 (Excl. quad Susp.) (Rear of front axle)	80-96			⊖	G63414	↔	Gas Ryder	OBS.	⊗	G63461	↔	Gas Ryder	OBS.		
F Series	F150 4x4 (Quad Susp.) (Forward of front axle)	80-96			⊖	G63410	↔	Gas Ryder	OBS.	⊗	G63461	↔	Gas Ryder	OBS.		
F Series	F250 4x4	78-81			†	G56154	↔	Safari	OBS.	⊖	G56155	↔	Safari			
F Series	F100	70-81		5	⊖	G56123	↔	Safari		⊖	G56118	↔	Safari			
F Series	F250 4x2	70-81		5	⊖	G56123	↔	Safari		⊖	G56118	↔	Safari			
F Series	F350	67-81			⊖	G56123	↔	Safari		⊗	G56102	↔	Safari			
F Series	F250 4x4	68-77			†	G45667	↔	Safari		⊗	G56121	↔	Safari	OBS.		
F Series	F100	68-69			⊖	G56123	↔	Safari		⊗	G56102	↔	Safari			
F Series	F250 4x2	68-69			⊖	G56123	↔	Safari		⊗	G56102	↔	Safari			
F Series	F100	65-67			†	G56119	↔	Safari		⊗	G56102	↔	Safari			
F Series	F250 4x2	65-67			†	G56119	↔	Safari		⊗	G56102	↔	Safari			
Falcon, Fairlane	Futura, Fairmont (Independent Susp.)	99-03			†	G55875	↔	Gas Ryder	OBS.	†	G55876	↔	Gas Ryder	OBS.		
Falcon, Fairlane	Futura, Fairmont (Without ind. Susp.)	99-03			†	G55875	↔	Gas Ryder	OBS.	⊖	69664	↔	Gas Ryder	OBS.		
Falcon, Fairlane	Futura, Fairmont	96-99			†	G55695	↔	Gas Ryder	OBS.	⊖	69664	↔	Gas Ryder	OBS.		
						G55695	↔	Gas Ryder	OBS.	†	69742	↔	Gas Ryder	OBS.		
Fiesta	Mk VI	08 on			†	70600	L	Gas Ryder		⊖	62009	↔	Gas Ryder			
						70601	R	Gas Ryder		⊖	62009	↔	Gas Ryder			
Fiesta	Mk V Hatch & Sedan	04-08			†	70567	L	Gas Ryder		⊖	61299	↔	Gas Ryder			4322
						70568	R	Gas Ryder		⊖	61299	↔	Gas Ryder			
Fiesta	Mk IV (Excl. 1.6 RSi 3-Door) (Sleeve eye) (Facelift)	99-03		22	†	55865	↔	Gas Ryder		†	69095	↔	Gas Ryder			4063
Fiesta	Mk IV (Excl. 1.6 RSi 3-Door) (U Bracket)	97-99		23	†	55865	↔	Gas Ryder		†	69082	↔	Gas Ryder			
Figo	1.4	10 on			†	70567	L	Gas Ryder		⊖	61299	↔	Gas Ryder			
						70568	R	Gas Ryder		⊖	61299	↔	Gas Ryder			
Focus	Mk III Hatch & Sedan (Excl. 2.5 ST & RS)	11 on			†	70771	L	Gas Ryder	NEW	⊖	62073	↔	Gas Ryder	NEW		
						70772	R	Gas Ryder	NEW	⊖	62073	↔	Gas Ryder	NEW		
Focus	Mk II Hatch & Sedan (Excl. STi)	04-11			†	70584	L	Gas Ryder		⊖	G45894	↔	Technomatic			
						70585	R	Gas Ryder		⊖	G45894	↔	Technomatic			
Focus	Mk I Hatch & Sedan	98-04			†	G35296	L	Gas Ryder		⊖	69422	↔	Gas Ryder			4316
						G35301	R	Gas Ryder		⊖	69422	↔	Gas Ryder			
Granada	Mk I, Mk II	72-86			⊖	G45503	↔	Technomatic		±	G45651	↔	Technomatic			4066
Husky	Minibus, LDV, Panel van	85-98			±	G56185	↔	Safari		⊗	G56102	↔	Safari			
						G45466	↔	Technomatic		⊗	G45051	↔	Technomatic			



F

Model	Derivative	Year	Vehicle Type	Note # (pg 6)	FRONT					REAR					GASLIFT	
					Shock Info	Part #	Side	Range	Status	Shock Info	Part #	Side	Range	Status	Front	Rear
FORD (CONT...)																
Ikon	Mk V Hatch & Sedan	07 on			†	70567	L	Gas Ryder		⊖	61299	↔	Gas Ryder			
					†	70568	R	Gas Ryder		⊖	61299	↔	Gas Ryder			
Ikon	(B3)	00-06		22	†	55865	↔	Gas Ryder		†	69095	↔	Gas Ryder			
KA	1.3 (Mk I)	05-09			†	G35326	↔	Gas Ryder		†	G51275	↔	Gas Ryder			
Laser, Meteor, Tracer	KF/KH	91-01			†	55825	↔	Gas Ryder		†	55804	↔	Gas Ryder			4087
					†	35848	↔	Technomatic		†	35833	↔	Technomatic			
Laser, Meteor, Tracer	KC/KE, GC	86-91			†	35832	↔	Technomatic		†	55804	↔	Gas Ryder			4087
					†	35832	↔	Technomatic		†	35833	↔	Technomatic			
Laser, Meteor, Tracer	Familia	69-76			⊖	82126	↔	Heavy Duty	OBS.	†	G45078	↔	Technomatic			
					⊖	45164	↔	Technomatic	OBS.	†	G45078	↔	Technomatic			
Louisville Line LNT 9000	Truck	76-83	g		⊗	76100	↔	Fleet Ryder	OBS.							
Mondeo	Mk III (Excl. Self Levelling)	01-07								⊗	69922	↔	Gas Ryder	OBS.		
Mondeo	Mk II	96-01			†	G35189	↔	Gas Ryder		†	G35112	↔	Gas Ryder			
Mondeo	Mk II (Excl. Self Levelling)	96-01			†	G35189	↔	Gas Ryder		⊗	69922	↔	Gas Ryder	OBS.		
Mustang	MK III	79-84			†	G56504	↔	Gas Ryder	OBS.	⊖	69633	↔	Gas Ryder	OBS.		
Ranchero	Falcon	97-98			†	G55695	↔	Gas Ryder	OBS.	†	69742	↔	Gas Ryder	OBS.		
Ranchero	Falcon	69-76			⊖	45164	↔	Technomatic	OBS.	†	G56105	↔	Safari			
					⊖	45164	↔	Technomatic	OBS.	†	G45078	↔	Technomatic			
Ranger	4x2 (Std. Susp.)	12 on			†	G56290	↔	Safari	NEW	⊗	G56291	↔	Safari	NEW		
Ranger	4x4, 4x2 Hi-Trail (Raised Susp.) T6	12 on			†	G546013	↔	Safari HDP	NEW	⊗	G578032	↔	Safari HDP	NEW		
					†	G56276	↔	Safari	NEW	⊗	G56277	↔	Safari	NEW		
Ranger	4x2 (Std. Susp.)	07-12			⊖	G56235	↔	Safari		⊗	G56228	↔	Safari			
Ranger	4x4, 4x2 Hi-Trail (Raised Susp.)	07-12			⊖	G556233	↔	Safari HDP		⊗	G578014	↔	Safari HDP			
					⊖	G56222	↔	Safari		⊗	G56223	↔	Safari			
Ranger	4x2 (Std. Susp.)	86-06			⊖	G56173	↔	Safari		⊗	G56116	↔	Safari			
					⊖	G45871	↔	Technomatic		⊗	G45872	↔	Technomatic			
Ranger	4x4, 4x2 Hi-Trail (Raised Susp.)	86-06			⊖	G556233	↔	Safari HDP		⊗	G578014	↔	Safari HDP			
					⊖	G56169	↔	Safari		⊗	G56170	↔	Safari			
Sapphire	1.6, 2.0, 2.3, 3.0 (Incl. XR6, Excl. XR8 & Estate)	83-93			†	35842	↔	Technomatic		⊗	G45860	↔	Technomatic			4080
Sierra	1.6, 2.0, 2.3, 3.0 (Incl. XR6, Excl. XR8 & Estate)	83-93			†	35842	↔	Technomatic		⊗	G45860	↔	Technomatic			4080
Sierra	1.6, 2.0, 2.3, 3.0 Estate	83-93			†	35842	↔	Technomatic		⊖	G45858	↔	Technomatic			4080
Spectron	Minibus, Van	91-03			⊖	G45876	↔	Technomatic		⊗	G56186	↔	Safari			4131
					⊖	G45876	↔	Technomatic		⊗	G45870	↔	Technomatic			

VEHICLE LISTING

Shocks, Struts, Gaslifts & Cartridges

FORD



F

Model	Derivative	Year	Vehicle Type	Note # (pg 6)	FRONT					REAR					GASLIFT	
					Shock Info	Part #	Side	Range	Status	Shock Info	Part #	Side	Range	Status	Front	Rear
FORD (CONT...)																
Taurus	17M, 20M	61-73		19	/	44874	↔	Technomatic	OBS.	⊕	G45423	↔	Technomatic			
Telstar	Incl. TX5	93-99			/	55843	L	Gas Ryder		/	55845	↔	Gas Ryder			4502
					/	55844	R	Gas Ryder		/	55845	↔	Gas Ryder			
Triton	0608, 0610	87 on	g		⊕	55211	↔	Safari								
Triton	0510, 0610	85-87	g		⊕	55088	↔	Safari		⊗	G56102	↔	Safari			
FREIGHTLINER																
Argosy 90 (Air Susp.)	Truck	19...	g		⊗	85918	↔	Heavy Duty		⊗	85724	↔	Heavy Duty			
Cab Over Tractors	Chassis cab	19...			⊗	83021	cab shock	Heavy Duty	OBS.							
FL112 Series	Truck	19...	g	28	⊗	85320	↔	Heavy Duty		⊗	85724	↔	Heavy Duty			
					⊗	85320	↔	Heavy Duty		⊗	85319	↔	Heavy Duty			
FL50, FL60, FL70, FL80	Truck	19...	g		⊗	77022	↔	Fleet Ryder								
GWM																
GWM	2.2, 2.8TDi (4x2)	07 on			⊕	G45862	↔	Technomatic		⊗	G45870	↔	Technomatic			
Steed	4x2	08 on			/	G45904	↔	Technomatic	NEW	⊗	G45905	↔	Technomatic	NEW		
HILLMAN																
Vogue, Hunter	Incl. Sceptre, Arrow	67-77			/	44529	↔	Technomatic	OBS.	⊕	36854	↔	Technomatic			
Vogue, Hunter	Safari	67-77			/	44529	↔	Technomatic	OBS.	⊗	G45051	↔	Technomatic			
HINO																
500	1626 Series	97 on	g		⊗	76207	↔	Fleet Ryder								
55/330, 55/350	Truck	85-94	g		⊗	76042	↔	Fleet Ryder								
9-136	Truck	02 on	g		⊕	55211	↔	Safari								
C40	Truck	93 on	g		⊗	76042	↔	Fleet Ryder								
FD 10-135	Truck	83-94	g		⊕	76132	↔	Fleet Ryder								
FE	Truck	83 on	g		⊕	76102	↔	Fleet Ryder								
FF13-133, FF14-173	Truck	83-94	g		⊗	76042	↔	Fleet Ryder								
GD, Super Dolphin	Truck	19...	g		⊗	76042	↔	Fleet Ryder								
KB 302, 342, 14-177	Truck	72-84	g		⊗	76042	↔	Fleet Ryder								
KL 340, KL360	Truck	72-83	g		⊕	76132	↔	Fleet Ryder								
KR 320, 360	Truck	74-84	g		⊕	76102	↔	Fleet Ryder								

Status: Part numbers marked as OBS. are obsolete or in the process of being phased out
 NEW – please refer to page 13 for more details | E&OE





HONDA

VEHICLE LISTING

Shocks, Struts, Gaslifts & Cartridges

H

Model	Derivative	Year	Vehicle Type	Note # (pg 6)	FRONT					REAR					GASLIFT	
					Shock Info	Part #	Side	Range	Status	Shock Info	Part #	Side	Range	Status	Front	Rear
HONDA																
Ballade	Mk VI 150i, 160i, 180i Excl. Vtech (Civic)	96-01			†	69084	↔	Gas Ryder		†	G55910	↔	Gas Ryder		4289	
Ballade	Mk V 150, 160i (SR4) (Civic)	92-96			†	69079	↔	Gas Ryder		†	69076	↔	Gas Ryder			
Ballade	Mk IV 150, 160i (SH4) (Civic)	89-92			†	69075	↔	Gas Ryder		†	69076	↔	Gas Ryder			
Ballade	Mk IV 160i (SH4) (Civic)	87-89		14	†	55820	↔	Gas Ryder	OBS.	†	69067	↔	Gas Ryder			
Ballade	Mk III 130, 150, 150i (SC9) (Civic)	84-88		14	†	55810	↔	Gas Ryder		†	69067	↔	Gas Ryder			
Ballade	Mk II	82-84			†	35830	↔	Technomatic		†	35831	↔	Technomatic			
Civic	Mk VIII Sedan	06-11			†	70598	L	Gas Ryder		⊕	62011	↔	Gas Ryder			
					†	70599	R	Gas Ryder		⊕	62011	↔	Gas Ryder			
Civic	Mk VII Hatch	01-05			†	70648	L	Gas Ryder	NEW	†	G51298	↔	Gas Ryder			
					†	70649	R	Gas Ryder	NEW	†	G51298	↔	Gas Ryder			
Civic	Mk VII Sedan	01-05			†	70648	L	Gas Ryder	NEW	†	G51298	↔	Gas Ryder			
					†	70649	R	Gas Ryder	NEW	†	G51298	↔	Gas Ryder			
Civic	Mk VI	96-01			†	69084	↔	Gas Ryder		†	G55910	↔	Gas Ryder		4289	
CR-V	Mk II 4x4 2.0, 2.2D (RD4, RDS, RD6, RD7)	02 on			†	70612	L	Gas Ryder		⊕	69104	↔	Gas Ryder			
					†	70613	R	Gas Ryder		⊕	69104	↔	Gas Ryder			
CR-V	Mk III	07-12			†	70718	L	Gas Ryder	NEW	†	69120	↔	Gas Ryder	NEW		
					†	70719	R	Gas Ryder	NEW	†	69120	↔	Gas Ryder	NEW		
CR-V	RD1-RD3	95-01			†	G51255	↔	Gas Ryder		†	G51256	↔	Gas Ryder			
Fit	Gen 1 (GD1)	07 on			†	70749	L	Gas Ryder	NEW	⊕	61296	↔	Gas Ryder			
					†	70750	R	Gas Ryder	NEW	⊕	61296	↔	Gas Ryder			
Jazz	Gen 2 (Fit)	08-13			†	70715	L	Gas Ryder	NEW	†	62058	↔	Gas Ryder	NEW		
					†	70716	R	Gas Ryder	NEW	†	62058	↔	Gas Ryder	NEW		
Jazz	1.4Dsi, 1.5 Gen 1 (Fit)	03-07			†	70610	L	Gas Ryder		⊕	61296	↔	Gas Ryder			
					†	70611	R	Gas Ryder		⊕	61296	↔	Gas Ryder			
Odyssey	RA1-RA5	97-99			†	G55877	↔	Gas Ryder		†	G55821	↔	Gas Ryder			
Prelude	Coupe	97-99								†	G55805	↔	Gas Ryder	OBS.		
Prelude	Coupe	92-97			†	G55795	↔	Gas Ryder	OBS.	†	G55805	↔	Gas Ryder	OBS.		
Prelude	Coupe	87-92			†	G55760	↔	Gas Ryder	OBS.	†	G55757	↔	Gas Ryder	OBS.		
Prelude	Coupe	83-87			†	G55723	↔	Gas Ryder		†	G44773	↔	Gas Ryder	OBS.		
Prelude	Coupe (Sealed Struts rear)	83-87			†	G55723	↔	Gas Ryder		†	G55516	↔	Gas Ryder	OBS.		



Model	Derivative	Year	Vehicle Type	Note # (pg 6)	FRONT					REAR					GASLIFT	
					Shock Info	Part #	Side	Range	Status	Shock Info	Part #	Side	Range	Status	Front	Rear
HYUNDAI																
Accent	MK4	11 on			⚡	70810	L	Gas Ryder	NEW	⊗	62093	↔	Gas Ryder	NEW		
					⚡	70811	R	Gas Ryder	NEW	⊗	62093	↔	Gas Ryder	NEW		
Accent	MC. 1.6 (Mk III)	05-11			⚡	G54023	L	Gas Ryder		⊖	62016	↔	Gas Ryder			
					⚡	G54024	R	Gas Ryder		⊖	62016	↔	Gas Ryder			
Accent	LC (Mk II)	00-05			⚡	70624	L	Gas Ryder		⚡	55870	↔	Gas Ryder			
					⚡	70625	R	Gas Ryder		⚡	55870	↔	Gas Ryder			
Accent	X3	98-00			⚡	55869	↔	Gas Ryder		⚡	55870	↔	Gas Ryder			
Accent	X3	94-97			⚡	55869	↔	Gas Ryder		⚡	55868	↔	Gas Ryder			
Atoz	Includes Prime (Mk II)	99 on			⚡	35951	L	Technomatic		⊗	69412	↔	Gas Ryder			
					⚡	35952	R	Technomatic		⊗	36867	↔	Technomatic			
Atoz	Mk I	97-98			⚡	G35284	L	Gas Ryder	OBS.	⊗	69412	↔	Gas Ryder			
					⚡	G35299	R	Gas Ryder	OBS.	⊗	69412	↔	Gas Ryder			
Elantra	HD Sedan	06-10			⚡	70793	L	Gas Ryder	NEW	⊖	62085	↔	Gas Ryder	NEW		
					⚡	70794	R	Gas Ryder	NEW	⊖	62085	↔	Gas Ryder	NEW		
Elantra	XD (J4) (Avante)	00-06			⚡	70519	L	Gas Ryder		⚡	70521	L	Gas Ryder			
					⚡	70520	R	Gas Ryder		⚡	70522	R	Gas Ryder			
Elantra	J2 & J3 Series (Avante)	96-00			⚡	70519	L	Gas Ryder		⚡	70544	L	Gas Ryder			
					⚡	70520	R	Gas Ryder		⚡	70545	R	Gas Ryder			
Elantra	J1 Series (Avante)	91-96			⚡	G55592	↔	Gas Ryder		⚡	G51059	↔	Gas Ryder			
Getz	3 & 5-door	03 on			⚡	70548	L	Gas Ryder		⊖	61285	↔	Gas Ryder			
					⚡	70549	R	Gas Ryder		⊖	61285	↔	Gas Ryder			
H1	Minibus, Multicab Bus, Panel van	09 on			⚡	70804	L	Gas Ryder	NEW	⊗	G56294	↔	Safari	NEW		
					⚡	70805	R	Gas Ryder	NEW	⊗	G56294	↔	Safari	NEW		
H100	Bakkie, minibus, van	96-05			⊖	G56176	↔	Safari		⊗	G56102	↔	Safari			
					⊖	G45535	↔	Technomatic		⊗	G45051	↔	Technomatic			
i10	Hatch	08 on			⚡	70569	L	Gas Ryder		⊖	62053	↔	Gas Ryder	NEW		
					⚡	70570	R	Gas Ryder		⊖	62053	↔	Gas Ryder	NEW		
i20	Hatch	09 on			⚡	70696	L	Gas Ryder	NEW	⊗	62039	↔	Gas Ryder			
					⚡	70697	R	Gas Ryder	NEW	⊗	62039	↔	Gas Ryder			
iX35	4x4, 4x2 (Excl. AWD)	10 on			⚡	70691	L	Gas Ryder	NEW	⊗	62036	↔	Gas Ryder	NEW		
					⚡	70692	R	Gas Ryder	NEW	⊗	62036	↔	Gas Ryder	NEW		
Matrix	(Lavita) Mini MPV	02 on			⚡	70550	L	Gas Ryder		⚡	70530	L	Gas Ryder			
					⚡	70551	R	Gas Ryder		⚡	70531	R	Gas Ryder			

Status: Part numbers marked as OBS. are obsolete or in the process of being phased out
 NEW – please refer to page 13 for more details | E&OE



Model	Derivative	Year	Vehicle Type	Note # (pg 6)	FRONT					REAR					GASLIFT	
					Shock Info	Part #	Side	Range	Status	Shock Info	Part #	Side	Range	Status	Front	Rear
HYUNDAI (CONT...)																
Santa Fe	SM (Mk I)	01-06			†	70554	L	Gas Ryder		⊕	61289	↔	Gas Ryder			
					†	70555	R	Gas Ryder		⊕	61289	↔	Gas Ryder			
Scoupe	Coupe	94-96			†	655586	↔	Gas Ryder	OBS.	⊗	69689	↔	Gas Ryder	OBS.		
Sonata	EF (MK IV)	03.01-02.05			†	69099	↔	Gas Ryder		†	69100	↔	Gas Ryder			
Sonata	EF (MK IV)	09.98-03.01			†	69099	↔	Gas Ryder								
Sonata	Y3 (Mk III)	95-98			†	655673	↔	Gas Ryder		†	651186	↔	Gas Ryder			
Terracan	2.9, 3.5	01-09			⊕	61287	↔	Gas Ryder		⊕	61288	↔	Gas Ryder			
Tiburon	RD & RD2	96-01			†	70519	L	Gas Ryder								
					†	70520	R	Gas Ryder								
Trajet	2.0, 2.7	01-08								⊗	61284	↔	Gas Ryder	OBS.		
Tucson	All	04-11			†	70637	L	Gas Ryder		†	70635	L	Gas Ryder			
					†	70638	R	Gas Ryder		†	70636	R	Gas Ryder			
INTERNATIONAL (TYCO)																
4700, 4900(4x2), 4900 (6x4)	Truck	93 on	g		+	76009	↔	Fleet Ryder								
9800 Eagle	Truck (Set back axle)	19...	g	27	⊕	76151	↔	Fleet Ryder		⊗	77018	↔	Fleet Ryder			
9800 Eagle	Truck (Set forward axle)	19...	g	27	⊗	76150	↔	Fleet Ryder	OBS.	⊗	77018	↔	Fleet Ryder			
ACCO 1600, 1830C	Truck	84-85	g		⊗	76042	↔	Fleet Ryder								
ACCO 1840D MK11	Truck	79-83	g		⊗	76042	↔	Fleet Ryder								
E-Line	Truck	19...	g		⊗	76008	↔	Fleet Ryder								
Fleetstar	Truck	19...	g		⊗	76015	↔	Fleet Ryder								
Loadstar 1850	Truck	71-78	g		⊗	76015	↔	Fleet Ryder								
Paystar F5070/350	Truck	73-84	g		⊗	76042	↔	Fleet Ryder								
S2670-407T, S Series	Truck	80-85	g		+	76006	↔	Fleet Ryder								
Transtar COF-4070	Truck	75-79	g		⊗	76042	↔	Fleet Ryder								
Unistar R91	Truck	19...	g		⊗	76042	↔	Fleet Ryder		⊗	76042	↔	Fleet Ryder			
ISUZU																
BD	Bus	74 on			⊗	76042	↔	Fleet Ryder		+	76006	↔	Fleet Ryder			
CVR, 49N	Truck	79-89	g		⊕	76102	↔	Fleet Ryder								
CVR, EXR, FT	Truck	89 on	g		⊕	76016	↔	Fleet Ryder								
F5000 (FN), F6599 (FN)	Truck	88 on	g		⊕	76102	↔	Fleet Ryder								
F8000 (TN), F9000 (TT)	Truck	88 on	g		⊕	76016	↔	Fleet Ryder								

VEHICLE LISTING

Shocks, Struts, Gaslifts & Cartridges

ISUZU



Model	Derivative	Year	Vehicle Type	Note # (pg 6)	FRONT					REAR					GASLIFT	
					Shock Info	Part #	Side	Range	Status	Shock Info	Part #	Side	Range	Status	Front	Rear
ISUZU (CONT...)																
Frontier	4x4, 4x2	98-02			⊕	G56173	↔	Safari		⊕	55088	↔	Safari			
FRR500	Truck	19...	g		⊕	55211	↔	Safari								
FSR700	Truck	96 on	g		⊕	76016	↔	Fleet Ryder								
FTR800	Truck	96 on	g		⊕	76043	↔	Fleet Ryder								
FTR800 4x2 FC	Truck	97 on	g		⊕	76204	↔	Fleet Ryder								
FVR2200 Turbo	Truck	93 on	g		⊕	76103	↔	Fleet Ryder								
FVR900 Turbo	Truck	93 on	g		⊕	76103	↔	Fleet Ryder								
FVZ1400	Truck	94 on	g		⊕	76043	↔	Fleet Ryder								
JCR 360, FTR	Truck	79-86	g		⊕	G56166	↔	Safari								
JCR 500	Truck	19...	g		⊕	76108	↔	Fleet Ryder								
KB (D-Max), TF Series	4x2 (Raised Height) (Mk VI)	13 on			†	G546014	↔	Safari HDP	NEW	⊗	G578038	↔	Safari HDP	NEW		
KB (D-Max), TF Series	4x4, (Raised Height) (Mk VI)	13 on			†	G546014	↔	Safari HDP	NEW	⊗	G578038	↔	Safari HDP	NEW		
KB (D-Max), TF Series	4x2 (Std. Height) (P190) (Mk V)	04-13 (Q1)			†	G56212	↔	Safari		⊗	G56213	↔	Safari			
KB (D-Max), TF Series	4x4, 4x2 (Raised Height) (P190) (Mk V)	04-13 (Q1)			⊕	G556225	↔	Safari HDP		⊗	G578006	↔	Safari HDP			
					⊕	G56214	↔	Safari		⊗	G56215	↔	Safari			
KB (D-Max), TF Series	4x4, 4x2 (Raised Height) (P190) (Mk V)	04-13 (Q1)			⊕	G556225	↔	Safari HDP		⊗	G578006	↔	Safari HDP			
					⊕	G56214	↔	Safari		⊗	G56215	↔	Safari			
KB (D-Max), TF Series	4x2 (Std. Height) (TF)	89-04			⊕	G45893	↔	Technomatic		⊗	G56103	↔	Safari			
					⊕	G45844	↔	Technomatic		⊗	G45008	↔	Technomatic			
KB (D-Max), TF Series	4x4, 4x2 (Raised Height) (TF)	89-04			⊕	G556225	↔	Safari HDP		⊗	G578006	↔	Safari HDP			
					⊕	G56173	↔	Safari		⊗	G56103	↔	Safari			
					⊕	G45871	↔	Technomatic		⊗	G45008	↔	Technomatic			
KB (D-Max), TF Series	4x4, 4x2 (Raised Height) (TF)	89-04			⊕	G556225	↔	Safari HDP		⊗	G578006	↔	Safari HDP			
					⊕	G56173	↔	Safari		⊗	G56103	↔	Safari			
					⊕	G45871	↔	Technomatic		⊗	G45008	↔	Technomatic			
KB (D-Max), TF Series	4x2 (Mk II)	80-88			⊕	G45893	↔	Technomatic		⊗	G56186	↔	Safari			
					⊕	G45844	↔	Technomatic		⊗	G45870	↔	Technomatic			
KB (D-Max), TF Series	4x4 (Mk II)	80-88			⊕	G56176	↔	Safari		⊗	G56186	↔	Safari			
					⊕	G45535	↔	Technomatic		⊗	G45870	↔	Technomatic			
KB (D-Max), TF Series	(Mk I)	78-80			⊕	G56176	↔	Safari		⊗	G56116	↔	Safari			
					⊕	G45535	↔	Technomatic		⊗	G45006	↔	Technomatic			

Status: Part numbers marked as OBS. are obsolete or in the process of being phased out
 NEW – please refer to page 13 for more details | E&OE



Model	Derivative	Year	Vehicle Type	Note # (pg 6)	FRONT					REAR					GASLIFT	
					Shock Info	Part #	Side	Range	Status	Shock Info	Part #	Side	Range	Status	Front	Rear
ISUZU (CONT...)																
N2800 P	Truck	93 on	g	29	⊥	55211	↔	Safari		⊗	76015	↔	Fleet Ryder			
					⊥	55211	↔	Safari		⊗	G56126	↔	Safari			
N3000 P	Truck	87-90	g	29	⊥	55211	↔	Safari		⊗	76015	↔	Fleet Ryder			
					⊥	55211	↔	Safari		⊗	G56126	↔	Safari			
N3500D FN 3.5T LWB 4x2 F-C	Truck	88-99	g							⊗	55242	↔	Safari			
N3500D, N4000D	Truck	86 on	g		⊥	76108	↔	Fleet Ryder		⊗	76110	↔	Fleet Ryder			
N4000D FT LWB Turbo 4x2 F-C	Truck	88-99	g							⊗	55242	↔	Safari			
NKR	Truck	96 on	g		⊥	76132	↔	Fleet Ryder								
NKR55/99	Truck	19...	g	29	⊥	55211	↔	Safari		⊗	76015	↔	Fleet Ryder			
					⊥	55211	↔	Safari		⊗	G56126	↔	Safari			
NPR 300, 400	Truck	86 on	g		⊥	76108	↔	Fleet Ryder		⊗	76110	↔	Fleet Ryder			
NPR 300, 400	Truck	84-03	g		⊥	55243	↔	Safari								
NPR 400 4x2 F-C	Truck	98 on	g							⊗	55240	↔	Safari			
NPR 66	Truck	19...	g							⊗	76135	↔	Fleet Ryder	OBS.		
NQR 500T 4x2 F-C	Truck	98-06	g							⊗	55240	↔	Safari			
SBR 422, FJR	Truck	76-83	g		⊥	76132	↔	Fleet Ryder		⊥	76043	↔	Fleet Ryder			
					⊥	55088	↔	Safari		⊥	76043	↔	Fleet Ryder			
SFR, TD	Truck	72 on	g	31	⊗	76007	↔	Fleet Ryder								
SLR, VPR	Truck	72 on	g		⊗	76042	↔	Fleet Ryder								
SPZ	Truck	73-80	g		⊗	76042	↔	Fleet Ryder								
SPZ, SHZ, SPR, SHR	Truck	80 on	g		⊥	76016	↔	Fleet Ryder								
TL40-50	Truck	75 on	g	29	⊥	55211	↔	Safari		⊗	76015	↔	Fleet Ryder			
					⊥	55211	↔	Safari		⊗	G56126	↔	Safari			
TLD 24	Truck	77-88	g		⊥	55211	↔	Safari		⊗	G56186	↔	Safari			
TLD44, TLD54	Truck	77-89	g	29	⊥	55211	↔	Safari		⊗	76015	↔	Fleet Ryder			
					⊥	55211	↔	Safari		⊗	G56126	↔	Safari			
TM, TX, TW Series	Truck	72 on	g		†	76003	↔	Fleet Ryder	OBS.							
TROOPER	Mk II	96-03			⊥	G63737	↔	Gas Ryder	OBS.	⊗	G63738	↔	Gas Ryder	OBS.		
TROOPER	Mk II	92-96			⊥	G56173	↔	Safari		⊗	EG63659	↔	Gas Ryder			
TROOPER	Mk I	81-91			⊥	G56176	↔	Safari		⊗	G56186	↔	Safari			
TXD 45	Truck	80-86	g		†	76003	↔	Fleet Ryder	OBS.							
WFR, RELAY	Fargo	80-95			±	G56185	↔	Safari		⊗	G45006	↔	Technomatic			4129

VEHICLE LISTING

Shocks, Struts, Gaslifts & Cartridges

IVECO



Model	Derivative	Year	Vehicle Type	Note # (pg 6)	FRONT					REAR					GASLIFT	
					Shock Info	Part #	Side	Range	Status	Shock Info	Part #	Side	Range	Status	Front	Rear
IVECO																
Daily	Panel van 107Kw_D (50C15, 65C15, 70C15)	04 on			⊗	76208	↔	Fleet Ryder		⊗	76209	↔	Fleet Ryder			
Daily	Panel van 92Kw_D (35S13, 50C13)	01-08			⊗	76208	↔	Fleet Ryder		⊗	76209	↔	Fleet Ryder			
Daily, Turbo Daily	35.10V, 45.10, A45.10, 40.10, 49.12, 59.12	95-00			⊗	42772	↔	Technomatic		⊗	42773	↔	Technomatic			
Daily, Turbo Daily	45.10, A45.10, 49.10	95-00			⊗	42772	↔	Technomatic		⊗	42772	↔	Technomatic			
Daily, Turbo Daily	49.10, 49.12, 59.12	19...			⊗	42772	↔	Technomatic		⊗	42772	↔	Technomatic			
Eurotech	MPL440E42T, 440E 34, 38, 42, 52	92 on	g		⊕	76156	↔	Fleet Ryder		⊗	76157	↔	Fleet Ryder			
Turbo Daily	42.12, 45.12, 54.12, 66.12	19...	g							⊗	42773	↔	Technomatic			
JAGUAR																
Jaguar	XJ6, XJ12 (4 shocks at rear) (Series 1, 2 and 3)	70-87			⊕	69677	↔	Gas Ryder		†	69066	↔	Gas Ryder	OBS.		
Jaguar	Mk X, 420, 420G, S Type (4 shocks at rear)	65-72		1	⊕	G45535	↔	Technomatic								
Jaguar	Mk II	61-69		1	⊕	G45535	↔	Technomatic		†	G56119	↔	Safari			
JEEP (CHRYSLER)																
Jeep	Patriot (MK)	07 on			†	70711	L	Gas Ryder	NEW	†	69117	↔	Gas Ryder	NEW		
					†	70712	R	Gas Ryder	NEW	†	69117	↔	Gas Ryder	NEW		
Jeep	Wrangler 4x4 (JK)	07-11			⊕	G556288	↔	Safari HDP	NEW	⊗	G556289	↔	Safari HDP	NEW		
Jeep	Cherokee (KJ) 2.5D, 2.8D, 3.7	01-07			†	G546011	↔	Safari HDP		⊗	G556267	↔	Safari HDP			
					†	G56262	↔	Safari		⊗	G56263	↔	Safari			
Jeep	Wrangler 4x4 (TJ)	96-06			⊕	G578025	↔	Safari HDP		⊗	G578026	↔	Safari HDP			
					⊕	G63721	↔	Gas Ryder		⊗	G63722	↔	Gas Ryder			
Jeep	Cherokee (XJ)	96-01			⊕	G578025	↔	Safari HDP		⊗	G556261	↔	Safari HDP			
Jeep	Grand Cherokee (ZJ)	96-99			⊕	G63424	↔	Gas Ryder	OBS.	⊗	G63683	↔	Gas Ryder	OBS.		
Jeep	Grand Cherokee (ZJ)	93-95			⊕	G63424	↔	Gas Ryder	OBS.	⊗	G63626	↔	Gas Ryder	OBS.		
Jeep	CJ Series (Willys) (CJ5, CJ6, CJ7)	54-86			⊗	G56102	↔	Safari		⊗	G56116	↔	Safari			
					⊗	G45051	↔	Technomatic		⊗	G45006	↔	Technomatic			
KENWORTH																
K374-29	Truck	19...	g		†	76003	↔	Fleet Ryder	OBS.							
KIA																
Carens	Mk I	99-06			†	70536	L	Gas Ryder	OBS.	†	70525	L	Gas Ryder	OBS.		
					†	70537	R	Gas Ryder	OBS.	†	70526	R	Gas Ryder	OBS.		
Cerato	Hatch & Sedan	09-13			†	70795	L	Gas Ryder	NEW	⊗	62086	↔	Gas Ryder	NEW		
					†	70796	R	Gas Ryder	NEW	⊗	62086	↔	Gas Ryder	NEW		
Clarus	2.0 GLX (Credos)	98-06			†	35943	L	Technomatic		†	35945	L	Technomatic			
					†	35944	R	Technomatic		†	35946	R	Technomatic			
K2700	Bongo (Gen 4)	05 on			⊕	G56251	↔	Safari		⊗	G56252	↔	Safari			
K2700	Bongo (Gen 3)	00-04			⊕	G56178	↔	Safari		⊗	G56103	↔	Safari			



KIA

VEHICLE LISTING

Shocks, Struts, Gaslifts & Cartridges

K

Model	Derivative	Year	Vehicle Type	Note # (pg 6)	FRONT					REAR					GASLIFT	
					Shock Info	Part #	Side	Range	Status	Shock Info	Part #	Side	Range	Status	Front	Rear
KIA (CONT...)																
Picanto	Mk II (TA)	11 on			†	70791	L	Gas Ryder	NEW	⊗	62084	↔	Gas Ryder	NEW		
					†	70792	R	Gas Ryder	NEW	⊗	62084	↔	Gas Ryder	NEW		
Picanto	Mk 1 Incl. 2007 & 2010 facelift (SA)	04-11			†	70569	L	Gas Ryder		⊗	62000	↔	Gas Ryder			
					†	70570	R	Gas Ryder		⊗	62000	↔	Gas Ryder			
Pregio	Bongo	00-04			±	G56178	↔	Safari								
Rio	1.3 & 1.6 (DC)	03-06			†	70620	L	Gas Ryder		⊗	62015	↔	Gas Ryder			
					†	70621	R	Gas Ryder		⊗	62015	↔	Gas Ryder			
Rio	1.3 & 1.6 (DC)	00-03								⊗	61295	↔	Gas Ryder			
					†	70517	L	Gas Ryder	OBS.							
Sedona/Carnival	Mk I	99-06			†	70518	R	Gas Ryder	OBS.							
Shuma	1.6, 1.8 (Shuma II)	02-04								†	70525	L	Gas Ryder	OBS.		
										†	70526	R	Gas Ryder	OBS.		
Shuma	1.6, 1.8 (Shuma I)	97-02								†	70525	L	Gas Ryder	OBS.		
										†	70526	R	Gas Ryder	OBS.		
Sorento	2.5D & 3.8 (Mk II)	07-09			†	G45898	L	Technomatic								
					†	G45899	R	Technomatic								
Sorento	2.5D & 3.5 (Mk I)	02-06			†	G45898	L	Technomatic		⊗	G56266	↔	Safari			
					†	G45899	R	Technomatic		⊗	G56266	↔	Safari			
Sportage	4x2 2.0, 2.4 – Gen2 (Excl. AWD)	10 on			†	70691	L	Gas Ryder	NEW	±	62036	↔	Gas Ryder	NEW		
					†	70692	R	Gas Ryder	NEW	±	62036	↔	Gas Ryder	NEW		
Sportage	2.0, 2.7, 2.0D (Mk II)	04-10			†	70637	L	Gas Ryder		†	70635	L	Gas Ryder			
					†	70638	R	Gas Ryder		†	70636	R	Gas Ryder			
Sportage	2.0, 2.0D (Mk I)	93-04			†	G51227	↔	Gas Ryder	OBS.	⊗	G63720	↔	Gas Ryder			
LADA																
Niva	VAZ-2121	87-92		16	⊗	G45893	↔	Technomatic		⊗	G56102	↔	Safari			
LANCIA																
Thema	Excl. 3.0 V8	84-94			†	G35013	↔	Gas Ryder	OBS.							
LAND ROVER																
Defender	90, 110, 130 (Incl. County & LDV)	84 on			+	G578007	↔	Safari HDP		♀	G578008	↔	Safari HDP			
					+	G56164	↔	Safari		♀	G56165	↔	Safari			
Defender	109 WB, Series II, III	65-84			⊗	G56112	↔	Safari		♀	G56113	↔	Safari			
Defender	109, 110 WB forward control	65-83			⊗	G56162	↔	Safari		♀	G56163	↔	Safari			
Defender	88 WB	54-80			⊗	G56112	↔	Safari		⊗	G56126	↔	Safari			
Defender	109 WB, Series I	54-65			⊗	G56112	↔	Safari		⊗	G56126	↔	Safari			
Discovery	Series II. 4.0 V8, 2.5TD5	98-04			⊗	G578029	↔	Safari HDP		⊗	G578030	↔	Safari HDP			
					⊗	G56246	↔	Safari		⊗	G56247	↔	Safari			
Discovery	Series I	89-98			+	G578007	↔	Safari HDP		♀	G578008	↔	Safari HDP			
					+	G56164	↔	Safari		♀	G56165	↔	Safari			



Model	Derivative	Year	Vehicle Type	Note # (pg 6)	FRONT					REAR					GASLIFT	
					Shock Info	Part #	Side	Range	Status	Shock Info	Part #	Side	Range	Status	Front	Rear
LAND ROVER (CONT...)																
Freelander	Mk II (L359)	4/07 on								†	70677	L	Gas Ryder	NEW		
										†	70678	R	Gas Ryder	NEW		
Freelander	Mk I (1.8, 2.0Td4, 2.5 V6)	98-3/07								†	70616	L	Gas Ryder	NEW		
										†	70617	R	Gas Ryder	NEW		
Range Rover	Air Susp. (Mk I)	92-96			†	G56180	↔	Safari		♀	G56165	↔	Safari			4205
Range Rover	Excl. air Susp. (Mk I)	70-96			†	G578007	↔	Safari HDP		♀	G578008	↔	Safari HDP			4205
					†	G56164	↔	Safari		♀	G56165	↔	Safari			
LEYLAND																
AEC MK IV	Bus	19...			†	76009	↔	Fleet Ryder								
AEC MK IV (With Air Cushions)	Bus	19...			♀	76042	↔	Fleet Ryder		♀	76042	↔	Fleet Ryder			
AEC MK IV (Without Air Cushions)	Bus	19...			♀	76042	↔	Fleet Ryder								
Buffalo	Truck	19...	g		†	76006	↔	Fleet Ryder								
Chieftain CH 4013, 14.10	Truck	79-86	g		♀	76042	↔	Fleet Ryder								
Clydesdale CD23	Bus	19...			†	76009	↔	Fleet Ryder								
Crusader	Truck	19...	g		†	76020	↔	Fleet Ryder								
Eland	Bus	19...			†	76006	↔	Fleet Ryder		†	76006	↔	Fleet Ryder			
Eland EL 4114, 14.12	Truck	73-85	g		†	76009	↔	Fleet Ryder		♀	76042	↔	Fleet Ryder			
FG 550, FG 420	Truck	68-77	g		♀	G56102	↔	Safari		♂	55088	↔	Safari			
Guy Victory J, Mk I	Bus	19...			†	76041	↔	Fleet Ryder		♀	76042	↔	Fleet Ryder			
Guy Victory J, Mk II	Bus	19...			†	76020	↔	Fleet Ryder		†	76006	↔	Fleet Ryder			
Kudu 352 RA, A691	Bus	19...			†	76041	↔	Fleet Ryder		†	76006	↔	Fleet Ryder			
Leopard	Truck	19...	g		†	76041	↔	Fleet Ryder		†	76020	↔	Fleet Ryder			
Mammoth Major, Mandator	Truck	19...	g		†	76009	↔	Fleet Ryder								
Marathon	Truck	76-83	g		♂	76016	↔	Fleet Ryder		♂	76103	↔	Fleet Ryder			
Mastiff	Truck	19...	g		♀	76042	↔	Fleet Ryder								
Monarch, 2TG4RE	Truck	19...	g		†	76009	↔	Fleet Ryder								
Pioneer Plus	Truck	19...	g		†	76006	↔	Fleet Ryder								
Road Train	Truck	19...	g		†	76006	↔	Fleet Ryder								
Super Comet	Truck	19...	g		†	76041	↔	Fleet Ryder								
Super Eland 22.12, 24.12	Truck	75-85	g		†	76041	↔	Fleet Ryder								
Swift	Bus	19...			♂	76043	↔	Fleet Ryder								
Tiger	Bus	19...			†	76020	↔	Fleet Ryder		†	76009	↔	Fleet Ryder			
Worldmaster	Bus	19...			†	76009	↔	Fleet Ryder								



Model	Derivative	Year	Vehicle Type	Note # (pg 6)	FRONT					REAR					GASLIFT	
					Shock Info	Part #	Side	Range	Status	Shock Info	Part #	Side	Range	Status	Front	Rear
MACK																
786FS	Truck	19...	g		⊗	76014	↔	Fleet Ryder								
R600RST, F700RST Series	Truck	73-85	g		⊗	76040	↔	Fleet Ryder								
MAGIRUS-DEUTZ																
130D, 232D 16S, 16FS	Truck	78-82	g		⊗	55224	↔	Safari	OBS.							
MAGNIS																
Samil	100	19...	g		⊗	77005	↔	Fleet Ryder								
Samil	20	19...	g		⊗	77003	↔	Fleet Ryder		†	77004	↔	Fleet Ryder			
Samil	50	19...	g		⊗	77005	↔	Fleet Ryder		†	77006	↔	Fleet Ryder			
MAHINDRA																
Bolero	4x4	05 on			⊕	61282	↔	Technomatic		⊗	61281	↔	Technomatic			
Scorpio	4x4, 4x2 raised. (Mk I) 2.2, 2.4D	06 on			⊕	G556264	↔	Safari HDP		⊗	G556265	↔	Safari HDP			
					⊕	G56203	↔	Safari		⊗	G56204	↔	Safari			
Scorpio	4x2	05 on			⊕	61283	↔	Technomatic		⊗	G45886	↔	Technomatic			
Scorpio	4x4	05 on			⊕	G45885	↔	Technomatic		⊗	G45886	↔	Technomatic			
MAN																
16, 201	Truck	19...	g		⊗	76021	↔	Fleet Ryder		†	76020	↔	Fleet Ryder			
16, 281	Bus	19...			⊗	76019	↔	Fleet Ryder		⊗	77009	↔	Fleet Ryder	OBS.		
27, 463	Truck	19...	g		⊕	76131	↔	Fleet Ryder								
16.220	Bus	19...			⊗	76021	↔	Fleet Ryder		†	76020	↔	Fleet Ryder			
16.240 FT/FTS/HT/HL/HAL/HAK	Truck	76-89	g		⊗	77003	↔	Fleet Ryder								
16.286, 16.320, 16.361 UL (Trailing Axle)	Truck	19...	g		⊗	77023	↔	Fleet Ryder	OBS.	⊗	77009	↔	Fleet Ryder	OBS.		
19.280 FT/FTS	Truck	78-90	g		⊗	77003	↔	Fleet Ryder								
19.291, 19.321 UL, 19.331, 19.361	Truck	19...	g		⊗	77023	↔	Fleet Ryder	OBS.							
19.292 FT/FTS	Truck	90-94	g		⊕	76131	↔	Fleet Ryder								
19.300FT, 19.320, 19.321 FT/FTS	Truck	85-90	g		⊕	76131	↔	Fleet Ryder								
19.362 FTS	Truck	89-93	g		⊕	76131	↔	Fleet Ryder								
22.192, 24.192 DHK, DHL	Truck	76-87	g		⊗	77003	↔	Fleet Ryder								
22.280, 22.320, 23.321 (Trailing Axle)	Truck	19...	g		⊗	77023	↔	Fleet Ryder	OBS.							
26.292 DFT/DFTS/DFL/DFK	Truck	89 on	g		⊕	76131	↔	Fleet Ryder								
26.362 DFTS/DFLS	Truck	90 on	g		⊕	76131	↔	Fleet Ryder								
26.372 DFT/DFTS	Truck	90-95	g		⊕	76131	↔	Fleet Ryder								

VEHICLE LISTING

Shocks, Struts, Gaslifts & Cartridges

MAN



M

Model	Derivative	Year	Vehicle Type	Note # (pg 6)	FRONT					REAR					GASLIFT	
					Shock Info	Part #	Side	Range	Status	Shock Info	Part #	Side	Range	Status	Front	Rear
MAN (CONT...)																
26.402 DFTS, 422	Truck	93 on	g		⊕	76131	↔	Fleet Ryder								
26.442, 26.552 DFTS	Truck	90 on	g		⊕	76131	↔	Fleet Ryder								
29.292 DFT/DFTS/DFL/DFK	Truck	89-92	g		⊕	76131	↔	Fleet Ryder								
30.240 DFK	Truck	85-90	g		⊗	77010	↔	Fleet Ryder	OBS.							
30.240 DHAK	Truck	76-89	g		⊗	77010	↔	Fleet Ryder	OBS.							
30.280 DHT	Truck	78-84	g		⊗	76021	↔	Fleet Ryder								
30.300, 30.321 DFT/K/L	Truck	85-90	g		⊗	77010	↔	Fleet Ryder	OBS.							
30.365 DFT/DFTS/DFL	Truck	86-89	g		⊕	76131	↔	Fleet Ryder								
30.380 DFT/DFTS/DFL	Truck	84-89	g		⊕	76131	↔	Fleet Ryder								
30.440 DFTS/DFL	Truck	87-90	g		⊕	76131	↔	Fleet Ryder								
F2000 27.463TS, 27.464 TS	Truck	19...	g		⊕	76131	↔	Fleet Ryder								
F2000 33.373 KN, TN	Truck	19...	g		⊕	76131	↔	Fleet Ryder								
F2000 33.374 K, L, T	Truck	19...	g		⊕	76131	↔	Fleet Ryder								
F2000 33.423TS	Truck	19...	g		⊕	76131	↔	Fleet Ryder								
F2000 40.464 TS	Truck	19...	g		⊕	76131	↔	Fleet Ryder								
M2000 14.153 L	Truck	19...	g		⊗	77003	↔	Fleet Ryder								
M2000 15.223L, 16.223L, K, LA	Truck	19...	g		⊕	76103	↔	Fleet Ryder								
MAZDA																
323	(Familia) Incl. Midge & Sting	91-04				⚡	55825	↔	Gas Ryder		⚡	55804	↔	Gas Ryder		4087
						⚡	35848	↔	Technomatic		⚡	35833	↔	Technomatic		
323	(BF) Incl. S, EGI, Sport	82-91				⚡	55803	↔	Gas Ryder		⚡	55804	↔	Gas Ryder		4087
						⚡	35832	↔	Technomatic		⚡	35833	↔	Technomatic		
323	(BD) Incl. S (Non Sealed Strut)	81-83			21	⚡	35832	↔	Technomatic		⚡	35833	↔	Technomatic		
323	Rwd (local strut)	78-81				⚡	44535	↔	Technomatic		⊗	G45810	↔	Technomatic		
323	Rwd (imported strut)	77-78				⚡	44225	↔	Technomatic	OBS.	⊗	G45810	↔	Technomatic		
616	Incl. Capella, Rx2	70-79				⚡	44532	↔	Technomatic	OBS.	⚡	51160	↔	Technomatic	OBS.	
626	1.8, 2.0 (Mk V), Y5 Sedan	99-03				⚡	70654	L	Gas Ryder	NEW	⚡	70656	L	Gas Ryder	NEW	
						⚡	70655	R	Gas Ryder	NEW	⚡	70657	R	Gas Ryder	NEW	
626	2.0, 2.5 (Incl. MX-6) (Mk IV)	92-98				⚡	55843	L	Gas Ryder		⚡	55845	↔	Gas Ryder		4271
						⚡	55844	R	Gas Ryder		⚡	55845	↔	Gas Ryder		
626	Incl. Coupe (Mk II, Mk III) (GC & GD)	83-92				⚡	55806	↔	Gas Ryder		⚡	55807	↔	Gas Ryder		4071
626	Zimbabwe model	87-91				⚡	G55600	↔	Gas Ryder		⚡	G55601	↔	Gas Ryder		



M

Model	Derivative	Year	Vehicle Type	Note # (pg 6)	FRONT					REAR					GASLIFT	
					Shock Info	Part #	Side	Range	Status	Shock Info	Part #	Side	Range	Status	Front	Rear
MAZDA																
1200, 1300	Familia (Mk II)	72-75			†	44216	↔	Technomatic	OBS.	†	G45078	↔	Technomatic			
B Series, Drifter, Magnum	4x2 Std. Susp.	86-07			‡	G56173	↔	Safari		⊗	G56116	↔	Safari			
					‡	G45871	↔	Technomatic		⊗	G45872	↔	Technomatic			
B Series, Drifter, Magnum	4x4, 4x2 Hi-Trail (Raised Susp.)	86-07			‡	G556233	↔	Safari HDP		⊗	G578014	↔	Safari HDP			
					‡	G56169	↔	Safari		⊗	G56170	↔	Safari			
B Series, Drifter, Magnum	Mk II, III & IV	64-86			±	G45212	↔	Technomatic		†	G56105	↔	Safari			
					±	G45212	↔	Technomatic		†	G45078	↔	Technomatic			
BT-50	4x2 Std. Susp.	12 on			†	G56290	↔	Safari	NEW	⊗	G56291	↔	Safari	NEW		
BT-50	4x4, 4x2 Raised Susp.	12 on			†	G546013	↔	Safari HDP	NEW	⊗	G578032	↔	Safari HDP	NEW		
					†	G56276	↔	Safari	NEW	⊗	G56277	↔	Safari	NEW		
BT-50	4x2 Std. Susp.	07-12			‡	G56235	↔	Safari		⊗	G56228	↔	Safari			
BT-50	4x4, 4x2 Raised Susp.	07-12			‡	G556233	↔	Safari HDP		⊗	G578014	↔	Safari HDP			
					‡	G56222	↔	Safari		⊗	G56223	↔	Safari			
Demio	Hatch DY	02-on			†	70567	L	Gas Ryder		‡	61299	↔	Gas Ryder			
					†	70568	R	Gas Ryder		‡	61299	↔	Gas Ryder			
E2000, E2700, E3000	LDV	66-83			†	G45667	↔	Technomatic		†	G56105	↔	Safari			
					†	G45667	↔	Technomatic		†	G45078	↔	Technomatic			
E2000, E3000	Truck	67-81	g		†	G45667	↔	Technomatic		†	G56105	↔	Safari			
					†	G45667	↔	Technomatic		†	G45078	↔	Technomatic			
Etude	1.6 (BJ) (Familia)	10/02-04			†	55888	L	Gas Ryder		†	55890	L	Gas Ryder			
					†	55889	R	Gas Ryder		†	55891	R	Gas Ryder			
Etude	1.6 (BJ) (Familia)	00-09/02								†	55890	L	Gas Ryder			
										†	55891	R	Gas Ryder			
F1000, F1300	LDV	81-86			±	G45523	↔	Technomatic		†	G56105	↔	Safari			
					±	G45523	↔	Technomatic		†	G45078	↔	Technomatic			
Familia	BJ	00-04			†	70741	L	Gas Ryder	NEW	†	70743	L	Gas Ryder	NEW		
					†	70742	R	Gas Ryder	NEW	†	70744	R	Gas Ryder	NEW		
Familia	BJE	99-00			†	70745	L	Gas Ryder	NEW	†	70747	L	Gas Ryder	NEW		
					†	70746	R	Gas Ryder	NEW	†	70748	R	Gas Ryder	NEW		
Marathon (Ford Husky)	Van, Bus	92-03			±	G45876	↔	Technomatic		⊗	G56186	↔	Safari			4131
					±	G45876	↔	Technomatic		⊗	G45870	↔	Technomatic			
Mazda 2	Hatch DE (Demio)	07 on			†	70600	L	Gas Ryder		‡	62009	↔	Gas Ryder			
					†	70601	R	Gas Ryder		‡	62009	↔	Gas Ryder			
Mazda 3	1.6, 2.0 Excl. 2.3 MPS (Mk I) (BK) (Axela)	04-09			†	70592	L	Gas Ryder		‡	G45892	↔	Technomatic			
					†	70593	R	Gas Ryder		‡	G45892	↔	Technomatic			
Mazda 6	All Excluding MPS (GG/GY)	03 on			†	69107	L	Gas Ryder								
					†	69108	R	Gas Ryder								
MX-5	Coupe	90-98			†	G51195	↔	Gas Ryder	OBS.	†	G51196	↔	Gas Ryder	OBS.		

VEHICLE LISTING

Shocks, Struts, Gaslifts & Cartridges

MAZDA



M

Model	Derivative	Year	Vehicle Type	Note # (pg 6)	FRONT					REAR					GASLIFT	
					Shock Info	Part #	Side	Range	Status	Shock Info	Part #	Side	Range	Status	Front	Rear
MAZDA (CONT...)																
Rustler	1300, 1600	94-02			†	35927	↔	Technomatic		⊗	G45878	↔	Technomatic			
Rustler	1400, 1600	86-94			†	35844	↔	Technomatic		⊗	G45875	↔	Technomatic			
Rustler	130, 160	85-86			†	35816	↔	Technomatic		⊗	G45875	↔	Technomatic			
RX7	Coupe	81-85			†	G44735	↔	Gas Ryder	OBS.	⊕	69674	↔	Gas Ryder	OBS.		
Soho	121 (Sleeved-Eye)	99-06		22	†	55865	↔	Gas Ryder		†	69095	↔	Gas Ryder			4063
Soho	121 (U-Bracket)	97-99		23	†	55865	↔	Gas Ryder		†	69082	↔	Gas Ryder			4063
T2000, T3000	LDV, Truck	81-86			⊕	55211	↔	Safari		⊗	G56177	↔	Safari			
T2000, T3000	LDV, Truck	83 on			⊕	55211	↔	Safari		⊗	G56177	↔	Safari			
MERCEDES-BENZ																
0.317	Bus	19...			†	76009	↔	Fleet Ryder		†	76020	↔	Fleet Ryder			
1735	Truck	19...	g		⊗	76033	↔	Fleet Ryder		⊗	76033	↔	Fleet Ryder			
0.302, 0.305 (Air Susp.)	Bus	19...			†	76009	↔	Fleet Ryder		†	76009	↔	Fleet Ryder			
0.309D	Bus	19...			⊗	55210	↔	Safari		⊗	55210	↔	Safari			
1113, L, LK, LF, LP, LPK	Truck	68-94	g	30	⊗	76039	↔	Fleet Ryder		⊗	76021	↔	Fleet Ryder			
1113B, L, LK	Truck	68-94	g		⊗	76019	↔	Fleet Ryder								
1113B, LA, LAK	Truck	73-83	g		⊗	76033	↔	Fleet Ryder								
					⊗	77007	↔	Fleet Ryder								
1113B, LAS	Truck	73-83	g		⊗	76033	↔	Fleet Ryder		⊗	76104	↔	Fleet Ryder			
					⊗	77007	↔	Fleet Ryder		⊗	76104	↔	Fleet Ryder			
1113B, LS	Truck	68-94	g		⊗	76019	↔	Fleet Ryder		⊗	76104	↔	Fleet Ryder			
114, 115 Series	220, 230, 240D, 280E, 280 (Excl.)	68-77			⊕	61201	↔	Gas Ryder		⊕	55208	↔	Safari			
1213, 1213K, 1217, 1217K	Truck	79-94	g		⊗	76033	↔	Fleet Ryder		⊕	77001	↔	Fleet Ryder			
1213AK	Truck	79-94	g		⊗	76106	↔	Fleet Ryder		⊕	77001	↔	Fleet Ryder			
1313, L, LK	Truck	72-76	g		⊗	76019	↔	Fleet Ryder		⊗	76022	↔	Fleet Ryder			
1313, LAK, LAS, LA	Truck	19...	g		⊗	76033	↔	Fleet Ryder		⊗	76104	↔	Fleet Ryder			
					⊗	77007	↔	Fleet Ryder		⊗	76104	↔	Fleet Ryder			
1313LS	Truck	19...	g		⊗	76019	↔	Fleet Ryder		⊗	76104	↔	Fleet Ryder			
1317L, LK	Truck	19...	g		⊗	76019	↔	Fleet Ryder		⊗	76022	↔	Fleet Ryder			
1317LP, LPK	Truck	19...	g							⊗	76022	↔	Fleet Ryder			
1319LP, LPK	Truck	19...	g							⊗	76022	↔	Fleet Ryder			
1413L, 1413K, 1417, 1417K	Truck	82-93	g		⊗	77007	↔	Fleet Ryder		⊕	77001	↔	Fleet Ryder			
					⊗	76033	↔	Fleet Ryder		⊕	77001	↔	Fleet Ryder			
1413L, LK, LS	Truck	76-82	g		⊗	76038	↔	Fleet Ryder	OBS.	⊗	76022	↔	Fleet Ryder			

Status: Part numbers marked as OBS. are obsolete or in the process of being phased out
 NEW – please refer to page 13 for more details | E&OE



M

Model	Derivative	Year	Vehicle Type	Note # (pg 6)	FRONT					REAR					GASLIFT	
					Shock Info	Part #	Side	Range	Status	Shock Info	Part #	Side	Range	Status	Front	Rear
MERCEDES-BENZ (CONT...)																
1418, L, LK	Truck	68-79	g		⊗	76021	↔	Fleet Ryder								
1418, LP, LPS	Truck	19...	g		⊗	76039	↔	Fleet Ryder								
1419, 1419K, 1419S	Truck	77-88	g		⊗	77007	↔	Fleet Ryder	⊗	77001	↔	Fleet Ryder				
					⊗	76033	↔	Fleet Ryder	⊗	77001	↔	Fleet Ryder				
1513, 1517LP, LPK	Truck	19...	g						⊗	76022	↔	Fleet Ryder				
1513, 1517LS	Truck	19...	g		⊗	76019	↔	Fleet Ryder	⊗	76104	↔	Fleet Ryder				
1513L, LK	Truck	70-75	g		⊗	76019	↔	Fleet Ryder	⊗	76022	↔	Fleet Ryder				
1513LA, LAK	Truck	19...	g		⊗	77007	↔	Fleet Ryder	⊗	76104	↔	Fleet Ryder				
					⊗	76033	↔	Fleet Ryder	⊗	76104	↔	Fleet Ryder				
1517, 1519, L, LK	Truck	75-80	g		⊗	76019	↔	Fleet Ryder	⊗	76022	↔	Fleet Ryder				
1517, 1519, LA, LAK	Truck	76-94	g		⊗	77007	↔	Fleet Ryder	⊗	76104	↔	Fleet Ryder				
					⊗	76033	↔	Fleet Ryder	⊗	76104	↔	Fleet Ryder				
1517, 1519, LAS	Truck	19...	g		⊗	77007	↔	Fleet Ryder	⊗	76022	↔	Fleet Ryder				
					⊗	76033	↔	Fleet Ryder	⊗	76022	↔	Fleet Ryder				
1617, LP, LPK	Truck	19...	g		⊗	76033	↔	Fleet Ryder	⊗	76022	↔	Fleet Ryder				
1618, L, LK	Truck	19...	g		⊗	76021	↔	Fleet Ryder								
1619, LP	Truck	19...	g		⊗	76033	↔	Fleet Ryder	⊗	76022	↔	Fleet Ryder				
1620, L, LK	Truck	19...	g		⊗	76021	↔	Fleet Ryder								
1621, L, LK, LS	Truck	77-79	g		⊗	76019	↔	Fleet Ryder								
1623, L, LK, LAK	Truck	19...	g		⊗	76021	↔	Fleet Ryder								
1624, L, LK, LAK, LS, LAS	Truck	19...	g		⊗	76019	↔	Fleet Ryder								
1813L	Truck	19...	g		⊗	77007	↔	Fleet Ryder								
					⊗	76033	↔	Fleet Ryder								
1817, 1819, L	Truck	19...	g		⊗	77007	↔	Fleet Ryder								
					⊗	76033	↔	Fleet Ryder								
1918, 1920, L, LK	Truck	19...	g		⊗	76021	↔	Fleet Ryder								
1921, L, LK, LS	Truck	70-77	g		⊗	76019	↔	Fleet Ryder								
1923L, LK	Truck	19...	g		⊗	76021	↔	Fleet Ryder								
1924, L, LK, LA, LAK, LS, LAS	Truck	19...	g		⊗	76019	↔	Fleet Ryder								
1926S, 1928, 1928S, 1933S	Truck	81-92	g		⊗	77007	↔	Fleet Ryder	⊗	76033	↔	Fleet Ryder				
					⊗	76033	↔	Fleet Ryder	⊗	76033	↔	Fleet Ryder				
2017, 2019, L, LB	Truck	19...	g		⊗	77007	↔	Fleet Ryder								
					⊗	76033	↔	Fleet Ryder								
2219, 2219K, 2224	Truck	82-93	g		⊗	76106	↔	Fleet Ryder								



Model	Derivative	Year	Vehicle Type	Note # (pg 6)	FRONT					REAR					GASLIFT	
					Shock Info	Part #	Side	Range	Status	Shock Info	Part #	Side	Range	Status	Front	Rear
MERCEDES-BENZ (CONT...)																
2220, L, LA, LS, LAS	Truck	19...	g		☉	76021	↔	Fleet Ryder								
2224B, 2225B	Truck	86-93	g		☉	76106	↔	Fleet Ryder								
2233S	Truck	82-86	g		☉	76033	↔	Fleet Ryder								
2620, L, LA, LS, LAS	Truck	19...	g		☉	76021	↔	Fleet Ryder								
2623, L, LS, LK, LA, LAS, LAK	Truck	19...	g		☉	76021	↔	Fleet Ryder								
2624, A, AK, K, S	Truck	81-88	g		☉	77007	↔	Fleet Ryder								
					☉	76033	↔	Fleet Ryder								
2624, L, LS, LK, LAK, LAS, LB, LAB	Truck	70-81	g		☉	76033	↔	Fleet Ryder								
2628K, A, S	Truck	81-93	g		☉	77007	↔	Fleet Ryder								
					☉	76033	↔	Fleet Ryder								
2629, LA, LAK, LAS	Truck	19...	g		☉	76021	↔	Fleet Ryder								
2632, L, K, AK, S, AS	Truck	75-83	g		☉	77007	↔	Fleet Ryder								
					☉	76033	↔	Fleet Ryder								
2633S, 2636S, 2638S	Truck	83-93	g		☉	77007	↔	Fleet Ryder								
					☉	76033	↔	Fleet Ryder								
2644S/32	Truck	94 on	g		☉	76033	↔	Fleet Ryder								
3328S, 3333S	Truck	87-92	g		☉	77007	↔	Fleet Ryder								
					☉	76033	↔	Fleet Ryder								
352 F	Bus	19...			☉	76036	↔	Fleet Ryder	☉	76022	↔	Fleet Ryder				
608 LP, LPK, LPS, LPO	Truck	19...	g		⊕	76037	↔	Fleet Ryder	OBS.	☉	55210	↔	Safari			
609, 811 LP, LPS, LPK	Truck	19...	g		⊕	76037	↔	Fleet Ryder	OBS.	☉	55210	↔	Safari			
808 LP, LPS, LPK	Truck	19...	g		⊕	76037	↔	Fleet Ryder	OBS.	☉	55210	↔	Safari			
911B, L, LK	Truck	19...	g		☉	76019	↔	Fleet Ryder								
911B, LA, LAK	Truck	19...	g		☉	77007	↔	Fleet Ryder								
					☉	76033	↔	Fleet Ryder								
911B, LAS	Truck	19...	g		☉	77007	↔	Fleet Ryder	☉	76104	↔	Fleet Ryder				
					☉	76033	↔	Fleet Ryder	☉	76104	↔	Fleet Ryder				
911B, LS	Truck	19...	g		☉	76019	↔	Fleet Ryder	☉	76104	↔	Fleet Ryder				
913, LP, LPK, LPS	Truck	19...	g		⊕	76037	↔	Fleet Ryder	OBS.							
A Class	(W168) A160, A190, 170CDI	00-04			⚡	G35365	↔	Gas Ryder	☉	69444	↔	Gas Ryder				4329
Actros	2031 S/36	99 on	g		☉	76033	↔	Fleet Ryder								
Actros	2643 LS/33, 2649LS/32	99 on	g		☉	76033	↔	Fleet Ryder								
Actros	3335 S/33	99 on	g		☉	76033	↔	Fleet Ryder								
Actros	3343 S/33	99 on	g		☉	76033	↔	Fleet Ryder								
Actros	1831LS/36, 1835/36	19...	g		☉	76033	↔	Fleet Ryder								
Atego	1017/48, 48AK, /36	19...	g		☉	76033	↔	Fleet Ryder								



M

Model	Derivative	Year	Vehicle Type	Note # (pg 6)	FRONT					REAR					GASLIFT	
					Shock Info	Part #	Side	Range	Status	Shock Info	Part #	Side	Range	Status	Front	Rear
MERCEDES-BENZ (CONT...)																
C Class	(CLC 203)	00-11			†	70808	↔	Gas Ryder	NEW	⊖	62092	↔	Gas Ryder	NEW		
C Class	C180, C200, C220CDi, C230, C270CDi, C280, C320CDi, C350 (W203)	00-07			†	70602	↔	Gas Ryder		⊖	62004	↔	Gas Ryder			
C Class	C180, C200, C220, C230, C250 (Excl. C280 & Sport Susp.) (W202)	94-00			⊖	61253	↔	Gas Ryder		⊖	61254	↔	Gas Ryder			
C Class	C180, C200, C220CDi, C230, C270CDi, C280, C320CDi, C350 (W203)	07 on								⊖	62032	↔	Gas Ryder	NEW		
C Class	C280 (W202)	94-00								⊖	61254	↔	Gas Ryder			
C Class	200, 230E, 260E, 300D, 300E (Excl. Ⓢ) (W124)	86-95			†	55815	↔	Gas Ryder		⊖	69744	↔	Gas Ryder			
C Class	190 Series (Excl. Ⓢ) (W201)	83-94			†	55815	↔	Gas Ryder		⊖	69744	↔	Gas Ryder			
C Class	200, 230E, 240D, 250, 280E, 300D (Excl. Ⓢ) (W123)	77-86			⊖	61202	↔	Gas Ryder		±	55208	↔	Safari			
C Class	C280 (W202)	94-00								⊖	61254	↔	Gas Ryder			
C Class	C180, C200, C220CDi, C230, C270CDi, C280, C320CDi, C350 (W203)	00-07			†	70602	↔	Gas Ryder		⊖	62004	↔	Gas Ryder			
C Class	(CLC 203)	00-11			†	70808	↔	Gas Ryder	NEW	⊖	62092	↔	Gas Ryder	NEW		
E Class	(W212)	09 on			†	70786	↔	Gas Ryder	NEW	⊖	62083	↔	Gas Ryder	NEW		
E Class	E200, E220D, E280, E280TD, E290TD (Excl. Ⓢ, Ⓢ) (W210)	95-02			⊖	69952	↔	Gas Ryder		⊖	69966	↔	Gas Ryder			
E Class	E230, E250D (W210)	95-99			⊖	69952	↔	Gas Ryder		⊖	69953	↔	Gas Ryder	OBS.		
Econoliner	1623S/36	96 on	g		⊗	76033	↔	Fleet Ryder								
Econoliner	1014/48, 1214/48	95 on	g		⊗	76033	↔	Fleet Ryder								
Econoliner	1617/48 & 52	94 on	g		⊗	76033	↔	Fleet Ryder		⊖	77001	↔	Fleet Ryder			
Econoliner	1414K/36, 1414/48	92 on	g		⊗	76033	↔	Fleet Ryder								
Econoliner	1617A/36, 1617K/36	92 on	g		⊗	76033	↔	Fleet Ryder		⊖	77001	↔	Fleet Ryder			
G Class	Gelandewagen (W463)	90 on								⊖	663636	↔	Gas Ryder	OBS.		
G Class	Gelandewagen (W460)	79-90			♀	663482	↔	Gas Ryder	OBS.	⊖	663483	↔	Gas Ryder	OBS.		
L1013, 1013K, 1014	Truck	81-87	g		⊗	76033	↔	Fleet Ryder		⊖	77001	↔	Fleet Ryder			
L408, L508, L608	Truck	79 on			⊗	55210	↔	Safari		⊗	55210	↔	Safari			
LA1213B	Truck	79-89			⊗	77007	↔	Fleet Ryder		⊗	76104	↔	Fleet Ryder			
					⊗	76033	↔	Fleet Ryder		⊗	76104	↔	Fleet Ryder			
MB 800	Bus	19...			⊗	55210	↔	Safari								
MB 800	Truck	19...			⊗	55210	↔	Safari								
OF 1113, 1313, 1317/51, 1413, 1417/52, 1617	Bus	19...			⊗	76036	↔	Fleet Ryder		⊗	76022	↔	Fleet Ryder			
OF 1621, 1624	Bus	86 on			⊗	76109	↔	Fleet Ryder		⊗	76104	↔	Fleet Ryder			
OH 1725L/59	Bus	19...			⊗	76033	↔	Fleet Ryder		†	76020	↔	Fleet Ryder			
OH 1835L/30	Bus	19...			⊗	76033	↔	Fleet Ryder		†	76020	↔	Fleet Ryder			



Model	Derivative	Year	Vehicle Type	Note # (pg 6)	FRONT					REAR					GASLIFT	
					Shock Info	Part #	Side	Range	Status	Shock Info	Part #	Side	Range	Status	Front	Rear
MERCEDES-BENZ (CONT...)																
Powerliner	2545S/32	96 on			∞	76033	↔	Fleet Ryder								
Powerliner	2638S/32	95 on			∞	76033	↔	Fleet Ryder								
Powerliner	1729S/32	94 on			∞	76033	↔	Fleet Ryder	∞	76019	↔	Fleet Ryder				
Powerliner	2535S/32	94 on			∞	76033	↔	Fleet Ryder								
Powerliner	1735S/35	92 on			∞	76033	↔	Fleet Ryder	∞	76019	↔	Fleet Ryder				
Powerliner	2426B/32 & 52	92 on			∞	76033	↔	Fleet Ryder								
Powerliner	2629K/32, 2629S/32, 2629/45	92 on			∞	76033	↔	Fleet Ryder								
Powerliner	2635S/32, 2635/45	92 on			∞	76033	↔	Fleet Ryder								
Powerliner	3836K/38	19...			∞	76033	↔	Fleet Ryder								
S Class	280SE, 300SE, 380SE, 420SE, 500SE, 560SE Incl. SEL & SEC (Excl. (W126))	81-93			⊥	61202	↔	Gas Ryder	⊥	55208	↔	Safari				
S Class	280SE, 280S, 350SE (Excl. (W116 Series))	73-81			⊥	61202	↔	Gas Ryder	⊥	55208	↔	Safari				
S Class	W108 Series	68-73			⊥	36760	↔	Technomatic	OBS.	⊥	36761	↔	Technomatic			
S Class	190, 200, 230 (W110 Series)	62-67			⊥	36760	↔	Technomatic	OBS.	⊥	36761	↔	Technomatic			
S Class	220, 250, 280 (W111 Series)	60-68			⊥	36760	↔	Technomatic	OBS.	⊥	36761	↔	Technomatic			
SL Class	450 SL, SLC (Excl. (R107))	73-81			⊥	61201	↔	Gas Ryder								
SL Class	280 SL, SLC, 350 SL, SLC (Excl. (R107))	71-81			⊥	61201	↔	Gas Ryder								
SLK Class	R170	96-04			⊥	69956	↔	Gas Ryder	OBS.	⊥	69957	↔	Gas Ryder	OBS.		
Sprinter	Panel van	06 on			†	70506	↔	Gas Ryder	NEW	∞	62008	↔	Gas Ryder	NEW		
Sprinter	308D (903) Cargo van	95-06								∞	42864	↔	Technomatic			
Sprinter	308D, 312D (903) Passenger van	95-06								∞	42864	↔	Technomatic			
Sprinter	312D Panel van (body length 319.5mm)	95-06								∞	42864	↔	Technomatic			
Sprinter	312D Panel van (body length 345.5mm)	95-06								∞	42864	↔	Technomatic			
Sprinter	412D (903) Cargo van	95-06								∞	83450	↔	Heavy Duty			
Sprinter	412D (903) Passenger van	95-06								∞	83450	↔	Heavy Duty			
Unimog	414, 416	19...			∞	76014	↔	Fleet Ryder		∞	76014	↔	Fleet Ryder			
Vito	115 CDi 2.2 Bus MPV Diesel (W639)	04 on								∞	G56268	↔	Safari			
Vito	115 CDi 2.2 Cr-Cab Panel van Diesel (W639)	04 on								∞	G56268	↔	Safari			
Vito	115 CDi 2.2 Panel van Diesel (W639)	04 on								∞	G56268	↔	Safari			
Vito	112 CDi 2.2 Cr-Cab Panel van Diesel (W638)	03-04			†	70538	↔	Gas Ryder		∞	61294	↔	Gas Ryder			
Vito	112 CDi 2.2 Panel van Diesel (W638)	02-04			†	70538	↔	Gas Ryder		∞	61294	↔	Gas Ryder			
W110 Series	190, 200, 230	62-67			⊥	36760	↔	Technomatic	OBS.	⊥	36761	↔	Technomatic			
W111 Series	220, 250, 280	60-68			⊥	36760	↔	Technomatic	OBS.	⊥	36761	↔	Technomatic			



M

Model	Derivative	Year	Vehicle Type	Note # (pg 6)	FRONT					REAR					GASLIFT	
					Shock Info	Part #	Side	Range	Status	Shock Info	Part #	Side	Range	Status	Front	Rear
MINI																
Cooper	One, Cooper & Cooper S (R50, R53)	02 on			†	70679	L	Gas Ryder	NEW	†	69109	↔	Gas Ryder	NEW		
					†	70680	R	Gas Ryder	NEW	†	69109	↔	Gas Ryder	NEW		
MITSUBISHI																
Canter	Truck	80 on			⊖	55088	↔	Safari		⊗	G56102	↔	Safari			
Colt	Galant Mk III (local strut)	78-83			/	44612	↔	Technomatic		⊗	G45812	↔	Technomatic			
Colt	Galant Mk III (imported strut)	77-78			/	44502	↔	Technomatic	OBS.	⊗	G45812	↔	Technomatic			
Colt	Dodge 1600, 2000, Mk II (Incl. Coupe)	72-77			/	44502	↔	Technomatic	OBS.	⊗	G45538	↔	Technomatic	OBS.		
Colt Bakkie	L200 (4x2 raised height)	98-07			⊖	G556220	↔	Safari HDP		⊗	G578003	↔	Safari HDP			
					⊖	G56172	↔	Safari		⊗	G56184	↔	Safari			
					⊖	G45893	↔	Technomatic		⊗	G56184	↔	Safari			
Colt Bakkie	L200 (4x2 Std. height)	98-07			±	G56185	↔	Technomatic		⊗	G56116	↔	Safari			
					±	G56185	↔	Technomatic		⊗	G45872	↔	Technomatic			
Colt Bakkie	L200 (4x4)	98-07			⊖	G556220	↔	Safari HDP		⊗	G578003	↔	Safari HDP			
					⊖	G56241	↔	Safari		⊗	G56184	↔	Safari			
					⊖	G56172	↔	Safari		⊗	G56184	↔	Safari			
Colt Bakkie	L200 (1.6, 2.0, 2.5D 4x2)	94-98			±	G56185	↔	Technomatic		⊗	G56116	↔	Safari			
Colt Bakkie	L200 (2.6, 3.0, V6 4x4, 4x2 raised height)	94-98			±	G556234	↔	Safari HDP		⊗	G578016	↔	Safari HDP			
					±	G56185	↔	Safari		⊗	G56184	↔	Safari			
FK Series	FK 115J/K	80-86			⊖	G56118	↔	Safari								
FM Series	FM215F/L	79-86			⊖	G56118	↔	Safari								
L300 (Delica)	Incl. Starwagon, Express	82-03			±	G56185	↔	Safari		⊗	G56102	↔	Safari			
					±	G45466	↔	Technomatic		⊗	G45051	↔	Technomatic			
Pajero	3.0, 3.8, 3.2 Di-D (Mk IV NS, SWB & LWB)	07 on			†	G546006	↔	Safari HDP		⊖	G578020	↔	Safari HDP			
					†	G56237	↔	Safari		⊖	G56238	↔	Safari			
Pajero	4x4 3.2 Di-D & 3.8 (Mk III) (SWB & LWB)	99-07			†	G546006	↔	Safari HDP		⊖	G578020	↔	Safari HDP			
					†	G56237	↔	Safari		⊖	G56238	↔	Safari			
Pajero	V Series (Mk II)	91-99			⊖	G556220	↔	Safari HDP		⊖	G578019	↔	Safari HDP			
					⊖	46004	↔	Safari		⊖	46005	↔	Safari			
Pajero Sport	Mk II (Chalenger)	09 on			†	G56205	↔	Safari								
Tredia	Excl. Turbo	83-86			†	35836	↔	Technomatic		⊗	G45824	↔	Technomatic			
Tredia	Turbo	83-86								⊗	G45824	↔	Technomatic			
Triton	4x4, 4x2 raised height	07 on			†	G546009	↔	Safari HDP		⊗	G578021	↔	Safari HDP			
					†	G56205	↔	Safari		⊗	G56210	↔	Safari			



N

Model	Derivative	Year	Vehicle Type	Note # (pg 6)	FRONT					REAR					GASLIFT	
					Shock Info	Part #	Side	Range	Status	Shock Info	Part #	Side	Range	Status	Front	Rear
NEOPLAN																
Cityliner	Bus	19...			†	77000	↔	Fleet Ryder		†	77000	↔	Fleet Ryder			
NISSAN																
1/2 Ton Bakkie	1400, 1200, 120Y	71-09			/	44217	↔	Technomatic		⊗	G45051	↔	Technomatic			
1/2 Ton Bakkie	1400 (13" wheels)	80-83			/	44510	↔	Technomatic		⊗	G45051	↔	Technomatic			
1/2 Ton Bakkie	120Y (12" wheels)	76-83			/	44217	↔	Technomatic		⊗	G45051	↔	Technomatic			
1 Ton Bakkie	Hardbody 4x2 (Excl. Hi Rider) (D22)	02 on			⊕	G45893	↔	Technomatic		⊗	G56190	↔	Safari			
					⊕	G45869	↔	Technomatic		⊗	G56190	↔	Safari			
1 Ton Bakkie	Hardbody 4x4, 4x2 Hi Rider (D22)	02 on			⊕	G556221	↔	Safari HDP		⊗	G578018	↔	Safari HDP			
					⊕	G56171	↔	Safari		⊗	G56190	↔	Safari			
1 Ton Bakkie	Hardbody 4x4 (D22)	98 on			⊕	G556221	↔	Safari HDP		⊗	G578018	↔	Safari HDP			
					⊕	G56171	↔	Safari		⊗	G56190	↔	Safari			
1 Ton Bakkie	Hardbody 4x2 (Excl. Hi Rider) (D21)	88-02			⊕	G45893	↔	Technomatic		⊗	G56116	↔	Safari			
1 Ton Bakkie	Hardbody 4x2 (Excl. Hi Rider) (D21)	88-02			⊕	G45869	↔	Technomatic		⊗	G45872	↔	Technomatic			
1 Ton Bakkie	Hardbody 4x2 Hi Rider Incl. Sani (D21)	88-02			⊕	G45893	↔	Technomatic		⊗	G56116	↔	Safari			
					⊕	G45893	↔	Technomatic		⊗	G45872	↔	Technomatic			
1 Ton Bakkie	Hardbody 4x4 (Incl. Sani, Patrol) (D21)	88-02			⊕	G56171	↔	Safari		⊗	G56116	↔	Safari			
					⊕	G56171	↔	Safari		⊗	G45872	↔	Technomatic			
1 Ton Bakkie	720 4x2	80-88			⊕	G56171	↔	Safari		⊗	G56102	↔	Safari			
					⊕	G45842	↔	Technomatic		⊗	G45051	↔	Technomatic			
1 Ton Bakkie	620, 680, 1300, 1500	66-80			⊕	G56171	↔	Safari		♀	G56157	↔	Safari			
					⊕	G45842	↔	Technomatic		♀	G45432	↔	Technomatic			
Almera	Excl. ABS (N16)	01-07			†	70500	L	Gas Ryder		†	69093	↔	Gas Ryder			
					†	70501	R	Gas Ryder		†	69093	↔	Gas Ryder			
Caball	Truck	96 on			⊕	G56179	↔	Safari		⊗	G56162	↔	Safari			
Caball	Truck	78-84			⊕	G45138	↔	Technomatic		♀	G56157	↔	Safari			
					⊕	G45138	↔	Technomatic		♀	G45432	↔	Technomatic			
Caball	Truck	64-78			⊕	G45138	↔	Technomatic		⊗	G56102	↔	Safari			
					⊕	G45138	↔	Technomatic		⊗	G45051	↔	Technomatic			
Cabstar	20, 35, 40	96 on								⊗	G56162	↔	Safari			
Cabstar	Truck	84-90			⊕	G56166	↔	Safari								
CB 20	Bus	19...			⊕	76103	↔	Fleet Ryder		⊕	76035	↔	Fleet Ryder			
CK10 K/A	Truck	74-86			⊕	76103	↔	Fleet Ryder								
CK20D/L/N	Truck	73-83			⊕	76103	↔	Fleet Ryder								
CK25D/N	Truck	83-84			⊕	76103	↔	Fleet Ryder								



N

Model	Derivative	Year	Vehicle Type	Note # (pg 6)	FRONT					REAR					GASLIFT	
					Shock Info	Part #	Side	Range	Status	Shock Info	Part #	Side	Range	Status	Front	Rear
NISSAN (CONT...)																
CK41 CT	Truck	80-85			♂	76103	↔	Fleet Ryder								
CM 10 F	Truck	87 on			♂	55088	↔	Safari								
CM 12/CM14	Truck	87 on			♂	76016	↔	Fleet Ryder								
CM 15 E	Truck	87-92			♂	76103	↔	Fleet Ryder								
CM 16 N	Truck	90 on			♂	76016	↔	Fleet Ryder								
CM 8 F	Truck	87-95			♂	55088	↔	Safari								
CM 90	Truck (Condor)	19...			†	76041	↔	Fleet Ryder								
CW 350 HTA, HTF	Truck	93 on			♂	76103	↔	Fleet Ryder								
CW290 HDN, PHN	Truck	93 on			♂	76103	↔	Fleet Ryder								
CW290 PPA, HTA, HTF, CK290 CTA	Truck	93-95			♂	76103	↔	Fleet Ryder								
CW41 H/P	Truck	77-85			♂	76103	↔	Fleet Ryder								
CW45 HD/PA	Truck	82-89			♂	76103	↔	Fleet Ryder								
CW46 HDN, HTE, HMF, HTA, PAN	Truck	89-93			♂	76103	↔	Fleet Ryder								
CW46 PAF, PAA	Truck	89-92			♂	76103	↔	Fleet Ryder								
CW47 HDN, HTA, HTF, PAF, PAN	Truck	93-95			♂	76103	↔	Fleet Ryder								
CW55 HTE, CW56 HTE	Truck	89-95			♂	76103	↔	Fleet Ryder								
E20 (Urvan, Caravan)	Ekonowagon, Ekonovan (Urvan, Caravan)	81-95			♂	G56176	↔	Safari		♀	G56157	↔	Safari			4162
					♂	G45535	↔	Technomatic		♀	G45432	↔	Technomatic			
E20 (Urvan, Caravan)	Ekonowagon, Ekonovan (Urvan, Caravan)	73-81			♂	G45122	↔	Technomatic		♀	G56157	↔	Safari			4162
					♂	G45122	↔	Technomatic		♀	G45432	↔	Technomatic			
Langley	Incl. Exa (Sealed Strut) (N12, MklI)	83-88			†	35847	↔	Technomatic		♂	G45859	↔	Technomatic			
Langley	Incl. Panache (N10, Mkl)	80-83			†	44227	↔	Technomatic		±	19289	↔	Technomatic			4099
Laurel	C230	78-87		13	†	44608	↔	Technomatic		†	69074	↔	Gas Ryder			
Laurel	240, 260, 300 (C130)	72-78		13	±	G45255	↔	Technomatic		⊗	G45008	↔	Technomatic			
Laurel	2000, 2300, 2400 (C30)	68-72			±	G45255	↔	Technomatic		♂	G45423	↔	Technomatic			
Livina	Incl. X-Gear & Grand Livina (XJ)	06 on			†	70589	L	Gas Ryder		♂	62094	↔	Gas Ryder	NEW		
					†	70590	R	Gas Ryder		♂	62094	↔	Gas Ryder	NEW		
Micra	Gen 4 (K13)	11 on			†	70806	L	Gas Ryder	NEW	♂	62091	↔	Gas Ryder	NEW		
					†	70807	R	Gas Ryder	NEW	♂	62091	↔	Gas Ryder	NEW		
Micra	Gen 3 5-Door (K12)	04-11			†	70575	L	Gas Ryder		♂	62001	↔	Gas Ryder			
					†	70576	R	Gas Ryder		♂	62001	↔	Gas Ryder			

VEHICLE LISTING

Shocks, Struts, Gaslifts & Cartridges

NISSAN



N

Model	Derivative	Year	Vehicle Type	Note # (pg 6)	FRONT					REAR					GASLIFT	
					Shock Info	Part #	Side	Range	Status	Shock Info	Part #	Side	Range	Status	Front	Rear
NISSAN (CONT...)																
Navara	4x4 & 4x2 (D40)	05-09			†	G546010	↔	Safari HDP		⊗	G556259	↔	Safari HDP			
					†	46003	↔	Safari		⊗	G56236	↔	Safari			
NP200	1.5, 1.6	08 on			†	70586	↔	Gas Ryder		⊖	62012	↔	Gas Ryder			
NP300	4x2 (Excl. Hi Rider) (D22)	08 on			⊖	G45893	↔	Technomatic		⊗	G56190	↔	Safari			
					⊖	G45869	↔	Technomatic		⊗	G56190	↔	Safari			
NP300	4x4 & 4x2 Hi Rider (D22)	08 on			⊖	G556221	↔	Safari HDP		⊗	G578018	↔	Safari HDP			
NP300	4x4 (D22)	08 on			⊖	G56171	↔	Safari		⊗	G56190	↔	Safari			
Pathfinder	2.5 Dci, 4.0 (Mk III R51 Series)	05-12			†	G546010	↔	Safari HDP		⊗	G556260	↔	Safari HDP			
Patrol	Station Wagon 4x4 (Y60, Y61, Rear for Y60 only)	89-01			†	G56105	↔	Safari		⊗	G56174	↔	Safari			
Patrol	4x4 (G160)	80-89			†	G56119	↔	Safari								
Patrol	4x4 (WG60)	72-80			†	G56119	↔	Safari		†	G56119	↔	Safari			
Primera	P11	98-02			†	G51213	↔	Gas Ryder		†	G51214	↔	Gas Ryder			
Pulsar	(Sealed Strut) (N12, MkII)	83-88			†	35847	↔	Technomatic		⊖	G45859	↔	Technomatic			
Pulsar	Incl. Panache (N10, MkI)	80-83			†	44227	↔	Technomatic		⊖	19289	↔	Technomatic			
Qashqai	1.6, 2.0, 1.5DCI (J10, JJ10)	07-14			†	70661	L	Gas Ryder	NEW	⊗	62026	↔	Gas Ryder			
					†	70662	R	Gas Ryder	NEW	⊗	62026	↔	Gas Ryder			
Sabre	160, 200 (Excl. ABS)	92-01			†	55838	L	Gas Ryder		†	55855	L	Gas Ryder			4515 LHS
					†	55839	R	Gas Ryder		†	55856	R	Gas Ryder			4516 RHS
Safari	Station Wagon (G160/G161) & Pickup	82-90			†	G56119	↔	Safari		⊖	G56168	↔	Safari			
Sani	4x2	90-99			⊖	G56172	↔	Safari		⊗	G56116	↔	Safari			
					⊖	G56172	↔	Safari		⊗	G45872	↔	Technomatic			
Sani	4x4	90-99			⊖	G56171	↔	Safari		⊗	G56116	↔	Safari			
					⊖	G45842	↔	Technomatic		⊗	G45872	↔	Technomatic			
Sentra	140	92-01			†	55838	L	Gas Ryder		†	55840	↔	Gas Ryder			4268
					†	55839	R	Gas Ryder		†	55840	↔	Gas Ryder			
Sentra	160, 200 (Excl. STi)	92-01			†	55838	L	Gas Ryder		†	55855	L	Gas Ryder			4268
					†	55839	R	Gas Ryder		†	55856	R	Gas Ryder			
Sentra	Sedan, Coupe (B12)	87-92			†	55816	↔	Gas Ryder		†	55817	↔	Gas Ryder			
Skyline	R31	87-92		13	†	61915	↔	Gas Ryder		†	69073	↔	Gas Ryder			
Skyline	1800, 2000 (R30)	82-87		13	†	44608	↔	Technomatic		†	69074	↔	Gas Ryder			
Skyline	2800 GLX, GTX (R30)	82-87		13	†	44608	↔	Technomatic		†	69073	↔	Gas Ryder			



N

Model	Derivative	Year	Vehicle Type	Note # (pg 6)	FRONT					REAR					GASLIFT	
					Shock Info	Part #	Side	Range	Status	Shock Info	Part #	Side	Range	Status	Front	Rear
NISSAN (CONT...)																
Stanza	1600J, 1800J, Stanza Station Wagon (A10)	79-83			/	44510	↔	Technomatic		⊗	G45006	↔	Technomatic		4068	
Stanza	1600J, 1800J Stanza, Resort (A10)	78-83			/	44510	↔	Technomatic		⊕	36854	↔	Technomatic			
Terrano II	R20 SWB	98-04			⊕	G56173	↔	Safari		⊗	G56184	↔	Safari			
Terrano II	R20 LWB	98-03			⊕	G56173	↔	Safari		⊗	G56184	↔	Safari			
Tiida	1.6i & 1.8i Hatch & Sedan	06 on			/	70589	L	Gas Ryder		⊕	62006	↔	Gas Ryder			
					/	70590	R	Gas Ryder		⊕	62006	↔	Gas Ryder			
Tracker	4x4 (Incl. Sani)	82-88			⊕	G56171	↔	Safari		⊗	G56186	↔	Safari			
					⊕	G45842	↔	Technomatic		⊗	G45870	↔	Technomatic			
Tracker	4x4	80-82			⊕	G56171	↔	Safari		⊗	G56168	↔	Safari			
					⊕	G45842	↔	Technomatic		⊗	G56168	↔	Safari			
U Series	160U, 180U	74-78			/	44500	↔	Technomatic		⊕	G45423	↔	Technomatic			
U Series	1600, 1800 (Incl. Coupe)	72-73			/	44500	↔	Technomatic		⊕	G45423	↔	Technomatic			
UD 35	4x2 F-C	96-10			⊕	55236	↔	Safari		⊗	55237	↔	Safari			
UD 35A	4x2 F-C	96-10			⊕	55236	↔	Safari		⊗	55237	↔	Safari			
UD 40L	Truck	96 on			⊕	55236	↔	Safari		⊗	55237	↔	Safari			
UD 80	4x2 F-C	97 on			⊕	76205	↔	Fleet Ryder		⊕	76206	↔	Fleet Ryder			
UD780	Truck	69 on			⊕	76102	↔	Fleet Ryder								
UG 80	Bus	19...			⊕	76102	↔	Fleet Ryder								
UG780	Truck	69 on			⊕	76102	↔	Fleet Ryder								
Vanette	C22	85-85		6	⊗	G45447	↔	Technomatic		⊗	G45051	↔	Technomatic			
X-Trail	4x4 & 4x2 (Mk II)	08 on			/	70663	L	Gas Ryder		⊗	62033	↔	Gas Ryder			
					/	70664	R	Gas Ryder		⊗	62033	↔	Gas Ryder			
X-Trail	4x4 & 4x2 (Mk I)	01-07			/	70556	L	Gas Ryder		/	70558	L	Gas Ryder			
					/	70557	R	Gas Ryder		/	70559	R	Gas Ryder			
Y Series	120Y, 140 SDX, (12" wheels)	75-80			/	44217	↔	Technomatic		⊕	36767	↔	Technomatic			
Y Series	140 SDX (13" wheels), 140Y, 160Y	75-80			/	44510	↔	Technomatic		⊕	36767	↔	Technomatic			
Y Series	140Y, 160Y	75-80			/	44510	↔	Technomatic		⊗	G45051	↔	Technomatic			
Y Series	140Y, 160Y LCV	75-80			/	44510	↔	Technomatic		⊕	G45533	↔	Technomatic			
Y Series	1200 LCV	72-75			/	44217	↔	Technomatic		⊕	G45122	↔	Technomatic			
Y Series	1200	71-75			/	44217	↔	Technomatic		⊕	36767	↔	Technomatic			
Z Series	280ZX (S130)	78-83			/	G44869	↔	Gas Ryder	OBS.							
Z Series	240Z, 260Z, 280Z (S30)	70-81			/	G44869	↔	Gas Ryder	OBS.						4204	

VEHICLE LISTING

Shocks, Struts, Gaslifts & Cartridges

OPEL



Model	Derivative	Year	Vehicle Type	Note # (pg 6)	FRONT					REAR					GASLIFT	
					Shock Info	Part #	Side	Range	Status	Shock Info	Part #	Side	Range	Status	Front	Rear
OPEL																
Astra	(H) 1.8 & 1.9 CDTi Incl. GTC (Excl. 2.0 Turbo Sport & OPC)	04-09			/	70631	L	Gas Ryder		⊗	62019	↔	Gas Ryder			
					/	70632	R	Gas Ryder		⊗	62019	↔	Gas Ryder			
Astra	Caravan, Excl. 2.0 OPC (G)	98-04			/	70505	↔	Gas Ryder		⊗	69987	↔	Gas Ryder			4221
Astra	Excl. 2.0 OPC (G) Hatch	99-03			/	70505	↔	Gas Ryder		⊗	G45881	↔	Technomatic			4272
Astra	Excl. 2.0 OPC (G) Sedan	99-03			/	70505	↔	Gas Ryder		⊗	G45881	↔	Technomatic			
Astra	F (Estate)	94-01		8	/	61918	↔	Gas Ryder		♀	61252	↔	Gas Ryder			
					/	44411	↔	Technomatic		♀	61252	↔	Gas Ryder			
Astra	F (Sedan)	93-99		14	/	61918	↔	Gas Ryder		♂	G45874	↔	Technomatic			
					/	44411	↔	Technomatic		♂	G45874	↔	Technomatic			
Commodore	C (Estate)	78-92			/	44611	↔	Technomatic		♂	G45399	↔	Technomatic			4014
Commodore	C (Sedan)	78-88			/	44611	↔	Technomatic		♂	G45489	↔	Technomatic			
Constantia, Kommando	Incl. Caprice, De Ville (AQ)	72-79			±	G45532	↔	Technomatic		♂	G45533	↔	Technomatic			4277
Constantia, Kommando	Brougham	69-72			±	G45255	↔	Technomatic		♂	G45533	↔	Technomatic			
Corsa	(D)	07 on			/	70706	L	Gas Ryder	NEW	♂	62044	↔	Gas Ryder	NEW		
					/	70707	R	Gas Ryder	NEW	♂	62044	↔	Gas Ryder	NEW		
Corsa	(B) Utility	04-12			/	70527	↔	Gas Ryder		⊗	G56224	↔	Safari			
					/	55858	↔	Gas Ryder		♂	61256	↔	Gas Ryder			4277
Corsa	(C) Excl. Corsa Lite	02-07			/	70504	↔	Gas Ryder		♂	61256	↔	Gas Ryder			4308
Corsa	(B) Utility	96-04			/	55858	↔	Gas Ryder		⊗	61257	↔	Gas Ryder			
Corsa	(B) Lite	96-02			/	55858	↔	Gas Ryder		♂	61256	↔	Gas Ryder			4277
Kadett	Astra	93-99		14	/	61918	↔	Gas Ryder		♂	G45874	↔	Technomatic			4260
					/	44411	↔	Technomatic		♂	G45874	↔	Technomatic			
Kadett	(E) T-car	89-93		14	/	61909	↔	Gas Ryder		♂	G45874	↔	Technomatic			4079
Kadett	T-car (E)	89-93		14	/	44607	↔	Technomatic		♂	G45874	↔	Technomatic			
Kadett	(E) T-car	85-89			/	61909	↔	Gas Ryder		♂	G45839	↔	Technomatic			4079
Kadett	T-car (E)	85-89			/	44607	↔	Technomatic		♂	G45839	↔	Technomatic			
Kadett	(D) Estate	80-85		7	/	61909	↔	Gas Ryder		♀	61252	↔	Gas Ryder			
Kadett	(D) Hatch	80-85			/	61909	↔	Gas Ryder		♂	G45839	↔	Technomatic			4069
Kadett	Estate (D)	80-85		7	/	44607	↔	Technomatic		♂	G45839	↔	Technomatic			
					/	44607	↔	Technomatic		♀	61252	↔	Gas Ryder			
Kadett	(B)	66-74								♂	G45533	↔	Technomatic			



Model	Derivative	Year	Vehicle Type	Note # (pg 6)	FRONT					REAR					GASLIFT	
					Shock Info	Part #	Side	Range	Status	Shock Info	Part #	Side	Range	Status	Front	Rear
OPEL (CONT...)																
Monza	Incl. Cub	89-93		14	/	61909	↔	Gas Ryder		⊕	G45874	↔	Technomatic			
					/	44607	↔	Technomatic		⊕	G45874	↔	Technomatic			
Monza	Incl. GSi	86-89			/	61909	↔	Gas Ryder		⊕	G45839	↔	Technomatic			
					/	44607	↔	Technomatic		⊕	G45839	↔	Technomatic			
Omega	Sedan, Estate (B)	01-04			/	EG35115	↔	Gas Ryder								
Rekord	380i V6	91-97			/	44611	↔	Technomatic		⊕	61230	↔	Gas Ryder			
Rekord	Sedan (Excl. V6) (E)	78-97			/	44611	↔	Technomatic		⊕	G45489	↔	Technomatic			
Rekord	Caravan (E)	78-92			/	44611	↔	Technomatic		⊕	G45138	↔	Technomatic			4014
Rekord	C	67-73			±	G45212	↔	Technomatic		⊕	G45533	↔	Technomatic			
Senator	3.0i 24V	87-94			/	EG35990	↔	Gas Ryder	OBS.	⊕	69460	↔	Gas Ryder	OBS.		
Senator	A	79-86			/	44611	↔	Technomatic		⊕	61230	↔	Gas Ryder			
Zafira	A	01-06			/	G35289	L	Gas Ryder		⊗	69415	↔	Gas Ryder			
					/	G35290	R	Gas Ryder		⊗	69415	↔	Gas Ryder			
OSHKOSH																
E-1344 T 290	Truck	78-83			⊗	76017	↔	Fleet Ryder								
E-1446 T 350	Truck	80-83			⊗	76017	↔	Fleet Ryder								
R Series	Truck	19...			⊗	76042	↔	Fleet Ryder								
PETERBILT																
320	Truck	95 on			⊗	76015	↔	Fleet Ryder								
362 E 436, 460, 550	Truck	95 on			⊗	77018	↔	Fleet Ryder								
377A/E	Truck	95 on			⊗	76015	↔	Fleet Ryder								
PEUGEOT																
206	1.4HDi, 2.0HDi	04-07			/	G35338	L	Gas Ryder		⊗	69446	↔	Gas Ryder			4330
					/	G35337	R	Gas Ryder		⊗	69446	↔	Gas Ryder			
206	1.6 Estate	03-07			/	G35338	L	Gas Ryder		⊗	69446	↔	Gas Ryder			4333
					/	G35337	R	Gas Ryder		⊗	69446	↔	Gas Ryder			
206	CC 1.6, CC 2.0	01-07			/	G35412	L	Gas Ryder	OBS.	⊗	69446	↔	Gas Ryder			
					/	G35413	R	Gas Ryder	OBS.	⊗	69446	↔	Gas Ryder			
206	1.4	01-06			/	70539	L	Gas Ryder		⊗	69401	↔	Gas Ryder			4330
					/	70540	R	Gas Ryder		⊗	69401	↔	Gas Ryder			
206	1.6	01-06			/	70539	L	Gas Ryder		⊗	69401	↔	Gas Ryder			4330
					/	70540	R	Gas Ryder		⊗	69401	↔	Gas Ryder			
206	2.0 GTi	00-06			/	G35338	L	Gas Ryder		⊗	69446	↔	Gas Ryder			4330
					/	G35337	R	Gas Ryder		⊗	69446	↔	Gas Ryder			



P

Model	Derivative	Year	Vehicle Type	Note # (pg 6)	FRONT					REAR					GASLIFT	
					Shock Info	Part #	Side	Range	Status	Shock Info	Part #	Side	Range	Status	Front	Rear
PEUGEOT (CONT...)																
207	CC 1.6 Sport 2 EU5	06 on			†	70763	L	Gas Ryder	NEW							
					†	70764	R	Gas Ryder	NEW							
207	GT 1.6 3-Door	06 on			†	70763	L	Gas Ryder	NEW							
					†	70764	R	Gas Ryder	NEW							
207	Hatch	06 on			†	70763	L	Gas Ryder	NEW	⊗	62046	↔	Gas Ryder	NEW		
					†	70764	R	Gas Ryder	NEW	⊗	62046	↔	Gas Ryder	NEW		
305	Series 2	83-85		11	†	44564	↔	Technomatic	OBS.							
305	Series 1	79-82			†	44564	↔	Technomatic	OBS.	†	51310	↔	Technomatic	OBS.		
306	Hatchback, Saloon & Cabriolet (Excl. Estate)	93-02			†	G35347	L	Gas Ryder	OBS.	⊗	69965	↔	Gas Ryder			
					†	G35348	R	Gas Ryder	OBS.	⊗	69965	↔	Gas Ryder			
307	Estate	02-08			†	G35369	L	Gas Ryder								
					†	G35370	R	Gas Ryder								
307	1.6, 2.0 (Excl. CC)	01-08			†	G35369	L	Gas Ryder		⊖	61286	↔	Gas Ryder		4331	
					†	G35370	R	Gas Ryder		⊖	61286	↔	Gas Ryder			
404	Estate	69-78			†	44509	↔	Technomatic	OBS.	⊗	G45470	↔	Technomatic			
404	LDV	60-81			†	44509	↔	Technomatic	OBS.	⊗	G45468	↔	Technomatic	OBS.		
404	Saloon	60-78			†	44509	↔	Technomatic	OBS.	†	G45258	↔	Technomatic			
406	Saloon	96-04			†	G35193	L	Gas Ryder	OBS.	⊖	69926	↔	Gas Ryder			
					†	G35199	R	Gas Ryder	OBS.	⊖	69926	↔	Gas Ryder			
406	SW	96-02			†	G35193	L	Gas Ryder	OBS.	⊖	69940	↔	Gas Ryder	OBS.		
					†	G35199	R	Gas Ryder	OBS.	⊖	69940	↔	Gas Ryder	OBS.		
504	L, GR	76-85			†	44604	↔	Technomatic		†	G45258	↔	Technomatic			
504	Estate	74-85			†	44606	↔	Technomatic		⊗	G45470	↔	Technomatic		4065	
504	GL, GLD, Ti	73-80			†	44604	↔	Technomatic		⊗	G45470	↔	Technomatic			
505	Saloon	80-85			†	44606	↔	Technomatic		⊖	G45450	↔	Technomatic			
806	Eurovan MPV	95-03			†	G35150	↔	Gas Ryder	OBS.	⊗	69914	↔	Gas Ryder	OBS.		
Partner	Van, LAV	99-02			†	G35347	L	Gas Ryder	OBS.							
					†	G35348	R	Gas Ryder	OBS.							
PORSCHE																
9Series	944	86-88			†	G44850	↔	Gas Ryder	OBS.	⊗	69760	↔	Gas Ryder	OBS.		
9Series	944	81-85			†	G44850	↔	Gas Ryder	OBS.	⊗	69616	↔	Gas Ryder	OBS.		
9Series	924	76-85			†	G44850	↔	Gas Ryder	OBS.	⊗	69616	↔	Gas Ryder	OBS.		
9Series	911	72-86			†	G44895	↔	Gas Ryder	OBS.	⊖	69614	↔	Gas Ryder	OBS.		
RAMBLER																
Hornet & Sportabout	AMC	70-76			‡	45164	↔	Technomatic	OBS.	†	G45258	↔	Technomatic			



RENAULT

VEHICLE LISTING

Shocks, Struts, Gaslifts & Cartridges

R

Model	Derivative	Year	Vehicle Type	Note # (pg 6)	FRONT					REAR					GASLIFT	
					Shock Info	Part #	Side	Range	Status	Shock Info	Part #	Side	Range	Status	Front	Rear
RENAULT																
CBH 385	Truck	96 on			†	77006	↔	Fleet Ryder								
Clio	Clio III Hatch	06-13			†	70682	↔	Gas Ryder	NEW	⊕	62043	↔	Gas Ryder	NEW		
Clio	Clio II 1.4, 1.5dCi & 1.6 (Excl. 1.2, 1.6 Sport, 2.0 & 3.0)	00-06			†	70512	↔	Gas Ryder		⊕	69989	↔	Gas Ryder			4298
Clio	Clio II 1.6 16V Sport	00-06			†	70809	↔	Gas Ryder	NEW	⊕	69425	↔	Gas Ryder			4298
Espace	III	97-04			†	G35343	L	Gas Ryder	OBS.	⊗	69938	↔	Gas Ryder	OBS.		
					†	G35344	R	Gas Ryder	OBS.	⊗	69938	↔	Gas Ryder	OBS.		
Fuego	3-door hatchback	80-85			†	G51323	↔	Gas Ryder	OBS.	†	69654	↔	Gas Ryder	OBS.		
Grand Scenic	Grand Scenic II	04-09			†	G35451	↔	Gas Ryder								
Laguna	I (Excl. Station Wagon)	96-00			†	35117	↔	Technomatic		⊗	69932	↔	Gas Ryder	OBS.		
Logan	U90	08 on			†	70639	↔	Gas Ryder		⊗	62025	↔	Gas Ryder			
Megane	I (Excl. Coupe)	96-03			†	70511	↔	Gas Ryder		⊗	69927	↔	Gas Ryder			
Megane	II Hatch (Excl. 2.0 T Sport)	04-08			†	G35421	↔	Gas Ryder		⊗	69538	↔	Gas Ryder			
Megane	II Sedan (Excl. 2.0 T Sport)	04-08			†	G35421	↔	Gas Ryder		⊗	69538	↔	Gas Ryder			
R12	Saloon, estate	71-75			†	51026	↔	Technomatic	OBS.	†	36764	↔	Technomatic	OBS.		
R5	Mk I Panel van	80-85			⊕	36850	↔	Technomatic		⊕	36851	↔	Technomatic			
R5	Mk I Hatchback	72-85			⊕	36850	↔	Technomatic		⊕	36851	↔	Technomatic			
R8, R10	Small sedan	62-70			⊕	19022	↔	Technomatic		⊕	19022	↔	Technomatic			
R9, R11	Saloon, hatchback	83-86			†	35824	↔	Technomatic		⊕	36851	↔	Technomatic			
Safrane	Phase 2	97-02			†	G35118	L	Gas Ryder	OBS.	†	G35120	↔	Gas Ryder	OBS.		
Safrane	Phase 2	97-02			†	G35119	R	Gas Ryder	OBS.	†	G35120	↔	Gas Ryder	OBS.		
Sandero	5-door hatchback	09-14			†	70639	↔	Gas Ryder		⊗	62025	↔	Gas Ryder			
Scenic	Scenic I (Excl.4x4)	98-04			†	70511	↔	Gas Ryder		⊗	62035	↔	Gas Ryder			4319 (Window) 4320 (Tailgate)
Scenic	Scenic II	04-09			†	G35451	↔	Gas Ryder		⊗	69512	↔	Gas Ryder			
ROVER																
ROVER	2600, 3500 (V8)	78-84		11	†	61912	↔	Gas Ryder	OBS.	†	61702	↔	Gas Ryder	OBS.		4014
SAAB																
9-3	SE 2.0, 2.0 Turbo, 2.3 (Mk I)	98-04			†	G44461	↔	Gas Ryder	OBS.	⊕	69891	↔	Gas Ryder	OBS.		
SAMAG																
130 – 12 FK/FL	Truck	83-87			⊗	55224	↔	Safari	OBS.							
168 – 16 K/L	Truck	83-87			⊗	55224	↔	Safari	OBS.							



Model	Derivative	Year	Vehicle Type	Note # (pg 6)	FRONT					REAR					GASLIFT	
					Shock Info	Part #	Side	Range	Status	Shock Info	Part #	Side	Range	Status	Front	Rear
SCANIA																
112, 142	Truck	19...			⊕	76035	↔	Fleet Ryder								
80, 110	Truck	19...			⊕	76016	↔	Fleet Ryder								
Bus	Bus	19...							⊕	76020	↔	Fleet Ryder				
K94	Bus	19...			⊕	76035	↔	Fleet Ryder								
LB 81 HS-31/50 4x2	Truck	75-82			⊕	76016	↔	Fleet Ryder	⊕	76006	↔	Fleet Ryder				
LBT 111-HS31 6x4	Truck	75-82			⊕	76016	↔	Fleet Ryder	⊕	76006	↔	Fleet Ryder				
LBT 141 HS-31/46 6x4	Truck	78-82			⊕	76016	↔	Fleet Ryder	⊕	76006	↔	Fleet Ryder				
P112H (6x2)	Truck	82-89			⊕	76035	↔	Fleet Ryder	⊕	76034	↔	Fleet Ryder				
P114GA 6x4 NZ 380	Truck	19...			⊕	76035	↔	Fleet Ryder								
P124 CB 6x4 NZ 470	Truck	19...			⊕	76035	↔	Fleet Ryder								
P124GA 400	Truck	19...			⊕	76035	↔	Fleet Ryder								
P124GA 6x4 NZ 420, 470	Truck	19...			⊕	76035	↔	Fleet Ryder								
P124LA 6x2 NA 420	Truck	19...			⊕	76035	↔	Fleet Ryder								
P142H (6x2)	Truck	82-89			⊕	76035	↔	Fleet Ryder	⊕	76034	↔	Fleet Ryder				
P82ML 4x2(S) 4x2	Truck	82-89			⊕	76035	↔	Fleet Ryder	⊕	76006	↔	Fleet Ryder				
P94LA 4x2 NA 310	Truck	19...			⊕	76035	↔	Fleet Ryder								
R112HL 6x4(S)	Truck	82-89			⊕	76035	↔	Fleet Ryder	⊕	76034	↔	Fleet Ryder				
R142H (6x4)	Truck	82-89			⊕	76035	↔	Fleet Ryder	⊕	76034	↔	Fleet Ryder				
SILVER EAGLE																
SAR Coach	Bus	19...			⊗	77002	↔	Fleet Ryder	⊗	76042	↔	Fleet Ryder				
SSANGYONG																
Musso	602TDi, E230EL, E320EL	95-06			⊕	G56173	↔	Safari	⊕	55088	↔	Safari				
Musso Sport	DC Bakkie	04 on			⊕	G56173	↔	Safari								
SUZUKI																
Alto	Gen 7	09 on							⊗	62037	↔	Gas Ryder				
Carry	Mk VIII	82-85			/	G44742	↔	Gas Ryder	OBS.	⊗	69769	↔	Gas Ryder	OBS.		4208
Jimny	Gen 3	98 on			⊕	G556283	↔	Safari HDP	NEW	⊗	G556284	↔	Safari HDP	NEW		
Jimny	Gen 3 - SN413 / JA/JB33	98 on			⊕	G45901	↔	Technomatic	NEW	⊗	G45902	↔	Technomatic	NEW		
SJ410/413, Samurai	4x4, Station Wagon	87-90			⊕	G45122	↔	Technomatic								
SJ410/413, Samurai	4x4, Station Wagon	82-87			⊕	G45122	↔	Technomatic		⊗	G45054	↔	Technomatic			



S

Model	Derivative	Year	Vehicle Type	Note # (pg 6)	FRONT					REAR					GASLIFT	
					Shock Info	Part #	Side	Range	Status	Shock Info	Part #	Side	Range	Status	Front	Rear
SUZUKI (CONT...)																
Swift	Gen 3	08 on			†	70689	L	Gas Ryder	NEW	⊕	62055	↔	Gas Ryder	NEW		
					†	70690	R	Gas Ryder	NEW	⊕	62055	↔	Gas Ryder	NEW		
SX4	4x2	08 on			†	70687	L	Gas Ryder	NEW							
					†	70688	R	Gas Ryder	NEW							
Vitara	5-Door (Excl. V6) (Mk I)	94-98			†	G56518	↔	Gas Ryder		†	G63799	↔	Gas Ryder			
TATA																
Indica	1.4 Hatch (V2) (Incl. B-Line, Excl. Tdi & ABS)	04 on			†	35934	L	Technomatic		†	51168	↔	Technomatic			
					†	35935	R	Technomatic		†	51168	↔	Technomatic			
Indigo	1.4 Sedan & Station Wagon	04 on			†	35936	L	Technomatic	OBS.	†	35938	L	Technomatic	OBS.		
					†	35937	R	Technomatic	OBS.	†	35939	R	Technomatic	OBS.		
LPT 1518TC	Truck	05 on			⊗	76185	↔	Fleet Ryder		⊗	76186	↔	Fleet Ryder			
LPT 509M 4x2 F-C	Truck	19...			⊗	36863	↔	Technomatic		⊗	55232	↔	Safari			
LPT 709 3T 4x2 F-C	Truck	19...			⊗	55233	↔	Safari		⊗	55234	↔	Safari			
LPT 713 S 4x2 F-C	Truck	19...			⊗	55233	↔	Safari		⊗	55234	↔	Safari			
LPT 713 S Chassis 4x2 Bus	Truck	19...			⊗	55233	↔	Safari		⊗	55234	↔	Safari			
SFC 407 2T 4x2 F-C	Truck	19...			⊗	36863	↔	Technomatic		⊗	55232	↔	Safari			
Telcoline	4x4, 4x2 Incl. Worker	04 on			⊕	55231	↔	Safari		⊗	36860	↔	Technomatic			
Xenon	3.0 4x2 & 4x4	07 on			⊕	G56249	↔	Safari		⊗	G56250	↔	Safari			
TOYOTA																
1200	LDV	78-82			†	44226	↔	Technomatic		⊗	19290	↔	Technomatic			
Auris	1.4 & 1.6 (330N)	07-12			†	70561	L	Gas Ryder		⊕	62022	↔	Gas Ryder			
					†	70562	R	Gas Ryder		⊕	62022	↔	Gas Ryder			
Auris	1.8 & 2.0 (330N)	07-12								⊕	62022	↔	Gas Ryder			
										⊕	62022	↔	Gas Ryder			
Avanza	1.3 & 1.5 (Xenia)	06 on			†	70579	L	Gas Ryder		⊗	G45891	↔	Technomatic			
					†	70580	R	Gas Ryder		⊗	G45891	↔	Technomatic			
Avenis	Gen 2 (T250)	06-10			†	70701	L	Gas Ryder	NEW							
					†	70702	R	Gas Ryder	NEW							
Bubble	(1NZ)	02-07			†	70752	L	Gas Ryder	NEW	†	69092	↔	Gas Ryder			
					†	70753	R	Gas Ryder	NEW	†	69092	↔	Gas Ryder			

VEHICLE LISTING

Shocks, Struts, Gaslifts & Cartridges

TOYOTA



T

Model	Derivative	Year	Vehicle Type	Note # (pg 6)	FRONT					REAR					GASLIFT	
					Shock Info	Part #	Side	Range	Status	Shock Info	Part #	Side	Range	Status	Front	Rear
TOYOTA (CONT...)																
Camry	XV20	97-01			∫	55886	L	Gas Ryder		∫	55848	L	Gas Ryder		4165	
					∫	55887	R	Gas Ryder		∫	55849	R	Gas Ryder			
Camry	(Gen 5) (SV20)	96-01			∫	70727	L	Gas Ryder	NEW	∫	55848	L	Gas Ryder			
					∫	70728	R	Gas Ryder	NEW	∫	55849	R	Gas Ryder			
Camry	XV10	93-97			∫	55846	L	Gas Ryder		∫	55848	L	Gas Ryder		4165	
					∫	55847	R	Gas Ryder		∫	55849	R	Gas Ryder			
Celica, Supra	A60 Series (MK III)	81-85			/	G44939	↔	Gas Ryder	OBS.	⊖	61228	↔	Gas Ryder			
Celica, Supra	A40, A50 (Mk II)	77-81			/	G44938	↔	Gas Ryder	OBS.							
Chaser	Mk II	92-02								⊖	69123	↔	Gas Ryder	NEW		
Condor	4x2 Mk IV	00-05			±	G45466	↔	Technomatic		⊖	G45872	↔	Technomatic		4521 Left	4522 Right
Condor	4x4 Mk IV	00-05			⊖	G45535	↔	Technomatic		⊖	G45006	↔	Technomatic		4521 Left	4522 Right
Conquest	FWD (E90)	89-07			∫	55818	↔	Gas Ryder		∫	55819	↔	Gas Ryder		4273	
Conquest	FWD (E80)	85-88			∫	55812	↔	Gas Ryder		∫	55813	↔	Gas Ryder		4063	
Corolla	1.3, 1.4, 1.6, 1.8, & 2.0 D4D (E140, E150)	07-14			∫	70561	L	Gas Ryder		⊖	61297	↔	Gas Ryder			
					∫	70562	R	Gas Ryder		⊖	61297	↔	Gas Ryder			
Corolla	1.3, 1.4, 1.6, 1.8, & 2.0 (E120), (E130)	02-07			∫	55892	L	Gas Ryder		∫	69092	↔	Gas Ryder			
					∫	55893	R	Gas Ryder		∫	69092	↔	Gas Ryder			
Corolla	NZE120/121, ZZE121	02 on								⊖	69103	↔	Gas Ryder			
Corolla	Excl. RSi (E100)	96-02			∫	55861	↔	Gas Ryder		∫	55863	↔	Gas Ryder			
Corolla	RSi (E100)	96-02			∫	55861	↔	Gas Ryder								
Corolla	FWD (E90)	89-96			∫	55818	↔	Gas Ryder		∫	55819	↔	Gas Ryder			
Corolla	FWD (Incl. Avante) (E80)	85-89			∫	55812	↔	Gas Ryder		∫	55813	↔	Gas Ryder			
Corolla	Imported strut (E30, E40, E50, E60)	82-85		10	/	44614	↔	Technomatic		⊖	G45399	↔	Technomatic			
Corolla	Estate (E70)	80-85													4207	
Corolla	RWD (Excl. Van, Station Wagon) (E70)	80-85			/	44614	↔	Technomatic		⊖	G45841	↔	Technomatic			
Corolla	Imported strut (E30, E40, E50, E60)	74-80		10	/	44614	↔	Technomatic		⊖	G45399	↔	Technomatic			
Corolla Carri	E90	98-05			∫	55818	↔	Gas Ryder		∫	55819	↔	Gas Ryder		4273	
Corolla Carri	Local strut (E30, E40, E50, E60)	79-89			/	44614	↔	Technomatic		⊖	G45399	↔	Technomatic			
Corolla Carri	Imported strut	73-79			/	44220	↔	Technomatic	OBS.	⊖	G45399	↔	Technomatic			



T

Model	Derivative	Year	Vehicle Type	Note # (pg 6)	FRONT					REAR					GASLIFT	
					Shock Info	Part #	Side	Range	Status	Shock Info	Part #	Side	Range	Status	Front	Rear
TOYOTA (CONT...)																
Corona	T100 Series	74-80			⊥	G45398	↔	Technomatic		⊥	G45841	↔	Technomatic			
Corona	Mk II 2000	72-78			⊥	G45398	↔	Technomatic		⊥	G45399	↔	Technomatic			
Corona	T60, T70 Series (Mk II 1900)	69-73			⊥	G45398	↔	Technomatic		⊥	G45006	↔	Technomatic			
CORONA	T40, T50 Series (Incl. 2000 GSL)	64-74			⊥	G45398	↔	Technomatic		⊥	G45399	↔	Technomatic			
Corona/Caldina	ST215G/W (2.0 & 2.0 Turbo 4WD GT & GTT)	12.99-09.02				↗	70571	L	Gas Ryder							
						↘	70572	R	Gas Ryder							
Corona/Caldina	ST210, CT210 2.0 & 2.0 Diesel Sedan	01.96-12.01				↗	70571	L	Gas Ryder	↗	70573	L	Gas Ryder			
						↘	70572	R	Gas Ryder	↗	70574	R	Gas Ryder			
Corona/Carina E	ST191, CT190 2.0 & 2.0 Diesel Sedan & LB:5-Door Hatchback	03.92-05.98				↗	70571	L	Gas Ryder	↗	70573	L	Gas Ryder			
						↘	70572	R	Gas Ryder	↗	70574	R	Gas Ryder			
Corona/Carina E	ST191, CT190 2.0 & 2.0 Diesel Sedan & LB:5-Door Hatchback with Harsh Road Package	02.96-05.98				↗	70571	L	Gas Ryder							
						↘	70572	R	Gas Ryder							
Corona/Carina E	AT190, ST191, CT190 Sedan made in the UK	01.96-10.97				↗	70571	L	Gas Ryder							
						↘	70572	R	Gas Ryder							
Corona/Carina E	ST191 2.0 Sedan & LB:5-Door Hatchback	03.92-02.96								↗	70573	L	Gas Ryder			
										↘	70574	R	Gas Ryder			
Corona/Carina E	ST191 2.0 Station Wagon	11.92-01.96				↗	70571	L	Gas Ryder							
						↘	70572	R	Gas Ryder							
Cressida	With IRS+, MX73 (Mk III)	83-93				↗	61903	↔	Gas Ryder	⊥	61212	↔	Gas Ryder			
						↘	44603	↔	Technomatic	⊥	61212	↔	Gas Ryder			
Cressida	MX63 (Mk II)	81-93				↗	61903	↔	Gas Ryder	⊥	G45469	↔	Technomatic	4084	4083	
						↘	44603	↔	Technomatic	⊥	G45469	↔	Technomatic			
Cressida	Non IRS+, MX63 (Mk II)	81-93				↗	61903	↔	Gas Ryder	⊥	61228	↔	Gas Ryder	4084		
						↘	44603	↔	Technomatic	⊥	G45813	↔	Technomatic			
Cressida	X30, X32 (local strut) (Mk I)	79-81			↗	44613	↔	Technomatic		⊥	61228	↔	Gas Ryder			
Cressida	X35, X36 (local strut) (Mk I)	79-81			↗	44613	↔	Technomatic		⊥	G45399	↔	Technomatic			
Cressida	X35, X36 (imported strut) (Mk I)	78-79			↗	44609	↔	Technomatic	OBS.	⊥	G45399	↔	Technomatic			
Cressida	X30, X32 (imported strut) (Mk I)	77-79				↗	44609	↔	Technomatic	OBS.	⊥	61228	↔	Gas Ryder		
						↘	44609	↔	Technomatic	OBS.	⊥	G45813	↔	Technomatic		

VEHICLE LISTING

Shocks, Struts, Gaslifts & Cartridges

TOYOTA



T

Model	Derivative	Year	Vehicle Type	Note # (pg 6)	FRONT					REAR					GASLIFT	
					Shock Info	Part #	Side	Range	Status	Shock Info	Part #	Side	Range	Status	Front	Rear
TOYOTA (CONT...)																
DA 110, 116	Truck	73 on			⊕	76016	↔	Fleet Ryder								
DA/KA	Truck	00 on			⊕	76043	↔	Fleet Ryder								
Dyna	7-145	08-on			⊕	55238	↔	Safari		⊗	55239	↔	Safari			
Dyna	5-103	08 on			⊕	36872	↔	Technomatic		⊗	55241	↔	Safari			
Dyna	6-104 4x2	04 on								⊗	36873	↔	Technomatic			
Dyna	7-105	03-on								⊗	55239	↔	Safari			
Dyna	8-145	03-on								⊗	55239	↔	Safari			
Dyna	4-093 4x2 F-C	02 on			⊕	36868	↔	Technomatic		⊗	36869	↔	Technomatic			
Dyna	Truck	94 on								⊗	G56102	↔	Safari			
Dyna	6-104 4x2	96-03								⊗	36874	↔	Technomatic			
Dyna	7-094	89-00			⊕	36870	↔	Technomatic		⊗	36871	↔	Technomatic			
Dyna	7-095 F-C, 4x2 (ADE364C)	89-00			⊕	36870	↔	Technomatic		⊗	36871	↔	Technomatic			
Dyna	7-105 LWB 4T 4x2 F-C	89-00								⊗	36873	↔	Technomatic			
Dyna	Coaster	78-95								⊗	G56102	↔	Safari			
Dyna	Coaster	66-77			⊗	G56102	↔	Safari		⊗	G56116	↔	Safari			
FJ Cruiser	4x4 SUV	11 on			†	G546012	↔	Safari HDP	NEW	⊕	G578037	↔	Safari HDP	NEW		
Fortuner	4x4, 4x2 Raised Susp.	06 on			†	G546007	↔	Safari HDP		⊕	G578010	↔	Safari HDP			
					†	G56218	↔	Safari		⊕	G56219	↔	Safari			
Harrier	SXU 10 (Gen 1)	97-03			†	70729	L	Gas Ryder	NEW	†	70735	L	Gas Ryder	NEW		
					†	70730	R	Gas Ryder	NEW	†	70736	R	Gas Ryder	NEW		
Harrier	SXU 15 (Gen 1)	97-03			†	70729	L	Gas Ryder	NEW	†	70737	L	Gas Ryder	NEW		
					†	70730	R	Gas Ryder	NEW	†	70738	R	Gas Ryder	NEW		
Hi-Ace	Super T (H100)	93-10			⊕	G56173	↔	Safari		⊗	G56175	↔	Safari			4163
Hi-Ace	SWB (H50)	88-93			⊕	G56241	↔	Safari		⊗	G56175	↔	Safari			
					⊕	G56172	↔	Safari		⊗	G56175	↔	Safari			
					⊕	G45893	↔	Technomatic		⊗	G45873	↔	Technomatic			
					⊕	G45869	↔	Technomatic		⊗	G45873	↔	Technomatic			
Hi-Ace	LWB (H20, H30, H40)	84-93			⊕	G56241	↔	Safari		⊗	G56175	↔	Safari			
					⊕	G56172	↔	Safari		⊗	G56175	↔	Safari			
					⊕	G45893	↔	Technomatic		⊗	G45873	↔	Technomatic			
					⊕	G45869	↔	Technomatic		⊗	G45873	↔	Technomatic			
Hi-Ace	SWB (H20, H30, H40)	84-88			⊕	G56241	↔	Safari		⊗	G56177	↔	Safari			
					⊕	G56172	↔	Safari		⊗	G56177	↔	Safari			
					⊕	G45893	↔	Technomatic		⊗	G45054	↔	Technomatic			
					⊕	G45869	↔	Technomatic		⊗	G45054	↔	Technomatic			
Hi-Ace	H10	69-84			⊕	G45466	↔	Technomatic		⊗	G56102	↔	Safari			
					⊕	G45466	↔	Technomatic		⊗	G45006	↔	Technomatic			
Hi-Ace	East Africa	19...								⊗	G56187	↔	Safari			



T

Model	Derivative	Year	Vehicle Type	Note # (pg 6)	FRONT					REAR					GASLIFT	
					Shock Info	Part #	Side	Range	Status	Shock Info	Part #	Side	Range	Status	Front	Rear
TOYOTA (CONT...)																
Hilux	4x2 Raised Susp. (Vigo)	05 on			⊥	G546007	↔	Safari HDP		⊗	G578009	↔	Safari HDP			
					⊥	G56218	↔	Safari		⊗	G56207	↔	Safari			
Hilux	4x2 Std. Susp. (Vigo)	05 on			†	G45888	L	Technomatic		⊗	G56208	↔	Safari			
					†	G45889	R	Technomatic		⊗	G56208	↔	Safari			
Hilux	4x4 Raised Susp. (Vigo)	05 on			⊥	G546007	↔	Safari HDP		⊗	G578009	↔	Safari HDP			
					⊥	G56218	↔	Safari		⊗	G56207	↔	Safari			
Hilux	4x2 Raised Susp.	99-05			⊥	G556232	↔	Safari HDP		⊗	G578004	L	Safari HDP			
					⊥	G556232	↔	Safari HDP		⊗	G578005	R	Safari HDP			
					⊥	G56189	↔	Safari		⊗	G56167	L	Safari			
					⊥	G56189	↔	Safari		⊗	G56174	R	Safari			
Hilux	4x2 Std. Susp.	99-05			±	G56178	↔	Safari		⊗	G56190	↔	Safari			
					±	G45862	↔	Technomatic		⊗	G45008	↔	Technomatic			
Hilux	4x4 Raised Susp.	99-05			⊥	G556232	↔	Safari HDP		⊗	G578004	L	Safari HDP			
					⊥	G556232	↔	Safari HDP		⊗	G578005	R	Safari HDP			
					⊥	G56189	↔	Safari		⊗	G56167	L	Safari			
					⊥	G56189	↔	Safari		⊗	G56174	R	Safari			
Hilux	4x2	84-98			±	G56178	↔	Safari		⊗	G56186	↔	Safari			
					±	G45862	↔	Technomatic		⊗	G45870	↔	Technomatic			
Hilux	4x4	84-98			⊥	G578000	↔	Safari HDP		⊗	G578001	↔	Safari HDP			
					⊥	G56158	↔	Safari		⊗	G56167	↔	Safari			
Hilux	4x4	79-84			⊥	G56158	↔	Safari		⊗	G56103	↔	Safari			
					⊥	G56158	↔	Safari		⊗	G45008	↔	Technomatic			
Hilux	4x2	69-84			±	G45398	↔	Technomatic		⊗	G45006	↔	Technomatic			
Ipsum	Avenis Verso (E121) (ACM2)	01-06			†	70754	L	Gas Ryder	NEW	⊥	62061	↔	Gas Ryder	NEW		
					†	70755	R	Gas Ryder	NEW	⊥	62061	↔	Gas Ryder	NEW		
Ipsum	Picnic (E110) (SM10)	96-01			†	70725	L	Gas Ryder	NEW	⊥	36876	↔	Technomatic	NEW		
					†	70726	R	Gas Ryder	NEW	⊥	36876	↔	Technomatic	NEW		
Land Cruiser*	79 Series	09 on			+	G56239	↔	Safari		⊗	G56240	↔	Safari			
Land Cruiser*	200	08 on			†	G578033	↔	Safari HDP	NEW	⊥	G578034	↔	Safari HDP	NEW		
Land Cruiser*	70SW	07 on			+	G578002	↔	Safari HDP		⊗	G578013	↔	Safari HDP			
Land Cruiser*	75SW	07 on			+	G578002	↔	Safari HDP		⊗	G578013	↔	Safari HDP			
Land Cruiser*	76SW	07 on			+	G578035	↔	Safari HDP	NEW	⊗	G578036	↔	Safari HDP	NEW		
Land Cruiser*	Pickup	99 on			+	G578002	↔	Safari HDP		⊗	G578013	↔	Safari HDP			
Land Cruiser*	105	99-07			+	G578011	↔	Safari HDP		⊥	G578012	↔	Safari HDP			

*Ensure correct model number

Status: Part numbers marked as OBS. are obsolete or in the process of being phased out

NEW – please refer to page 13 for more details | E&OE

VEHICLE LISTING

Shocks, Struts, Gaslifts & Cartridges

TOYOTA



T

Model	Derivative	Year	Vehicle Type	Note # (pg 6)	FRONT					REAR					GASLIFT	
					Shock Info	Part #	Side	Range	Status	Shock Info	Part #	Side	Range	Status	Front	Rear
TOYOTA (CONT...)																
Land Cruiser*	HDJ100, UZJ100 (Excl. Air Susp.)	98-02			⊥	83455	↔	Heavy Duty		⊥	83456	↔	Heavy Duty			
Land Cruiser*	HDJ105 / UZJ105 (Excl. Air Susp.)	98-02								⊥	83456	↔	Heavy Duty			
Land Cruiser*	100 Series	90-98								⊥	G56231	↔	Safari			
Land Cruiser*	80	90-98			†	G578011	↔	Safari HDP		⊥	G578012	↔	Safari HDP			
Land Cruiser*	HZJ80 Station Wagon, HZJ105 Station Wagon	90-98			†	G56230	↔	Safari		⊥	G56231	↔	Safari			
Land Cruiser*	HZJ70	89-99			⊥	G56179	↔	Safari		⊗	G56167	↔	Safari			
Land Cruiser*	DLX, BJ75	85-99			⊥	G56179	↔	Safari		⊗	G56174	↔	Safari			
Land Cruiser*	FJ62, BJ60 Station Wagon	83-89			⊥	G56166	↔	Safari		⊗	G56186	↔	Safari			
Land Cruiser*	FJ45, BJ45	71-85			⊗	G56177	↔	Safari		⊗	G56186	↔	Safari			
					⊗	G45051	↔	Technomatic		⊗	G45008	↔	Technomatic			
Prado	J150 (Excl. ⚡)	09 on			†	G546012	↔	Safari HDP	NEW	⊥	G578037	↔	Safari HDP	NEW		
					†	G56292	↔	Safari	NEW	⊥	G56293	↔	Safari	NEW		
Prado	120/125	02-09			†	G546007	↔	Safari HDP		⊥	G578017	↔	Safari HDP			
					†	G56226	↔	Safari		⊥	G56227	↔	Safari			
Prado	90 SWB & 95 LWB	96-02			†	G546008	↔	Safari HDP		⊥	G578015	↔	Safari HDP			
					†	46001	↔	Safari		⊥	46002	↔	Safari			
					†	51240	↔	Technomatic		⊥	83454	↔	Heavy Duty			
Previa	2.7, 2.5 ⚡-4D (Bus, LWB Panel van) (H200)	90-99			†	G55652	L	Gas Ryder	OBS.	†	G63920	↔	Gas Ryder	OBS.		
					†	G55653	R	Gas Ryder	OBS.	†	G63920	↔	Gas Ryder	OBS.		
Quantum	2.5 ⚡-4D, 2.7 Minibus & Van Incl. Sesfikile (H200)	05 on			⊥	G56211	↔	Safari		⊗	G56209	↔	Safari			
Rav4	XA30 (Mk III)	06 on								⊗	62014	↔	Gas Ryder			
										⊗	62014	↔	Gas Ryder			
Rav4	XA20 (Mk II)	01-06			†	70628	L	Gas Ryder		⊥	62020	↔	Gas Ryder			
					†	70629	R	Gas Ryder		⊥	62020	↔	Gas Ryder			
Rav4	Sealed Struts (XA10) Mk I	98-00			†	70523	L	Gas Ryder		⊥	G63940	↔	Gas Ryder			
					†	70524	R	Gas Ryder		⊥	36865	↔	Technomatic			
Rav4	Serviceable front struts (XA10) Mk I	95-98			†	G44782	↔	Gas Ryder		⊥	G63940	↔	Gas Ryder			
					†	G44782	↔	Gas Ryder		⊥	36865	↔	Technomatic			
RunX	E120, E130	02-07			†	55892	L	Gas Ryder		†	69092	↔	Gas Ryder			
					†	55893	R	Gas Ryder		†	69092	↔	Gas Ryder			
Spaceo	(AE114) (Mk I) (E110)	97-01			†	70731	L	Gas Ryder	NEW	⊥	70733	L	Gas Ryder	NEW		
					†	70732	R	Gas Ryder	NEW	⊥	70734	R	Gas Ryder	NEW		

*Ensure correct model number

Status: Part numbers marked as OBS. are obsolete or in the process of being phased out

NEW – please refer to page 13 for more details | E&OE



T

Model	Derivative	Year	Vehicle Type	Note # (pg 6)	FRONT					REAR					GASLIFT	
					Shock Info	Part #	Side	Range	Status	Shock Info	Part #	Side	Range	Status	Front	Rear
TOYOTA (CONT...)																
Stallion	KF40	87-00			±	G56185	↔	Safari		⊗	G56102	↔	Safari			
					±	G56185	↔	Safari		⊗	G45051	↔	Technomatic			
Stout	RK 101	61-89			⊖	G45138	↔	Technomatic		⊗	G56116	↔	Safari			
					⊖	G45138	↔	Technomatic		⊗	G45006	↔	Technomatic			
Tazz	FWD (E90)	96-07			†	55818	↔	Gas Ryder		†	55819	↔	Gas Ryder		4273	
Tercel	Starlet (EL4/NL4)	90-96			†	70739	L	Gas Ryder	NEW	†	69122	↔	Gas Ryder	NEW		
					†	70740	R	Gas Ryder	NEW	†	69122	↔	Gas Ryder	NEW		
Tuv	LDV	82-87			†	G45001	↔	Technomatic		⊗	G45006	↔	Technomatic			
Venture	KF40 (Minibus)	91-00			±	G56185	↔	Safari		⊗	G56102	↔	Safari		4199	
					±	G56185	↔	Safari		⊗	G45051	↔	Technomatic			
Verso	1.6, 1.8, 2.0 (Mk III) (Spacio) (AR 10)	04-09			†	70618	L	Gas Ryder		⊖	69106	↔	Gas Ryder			
					†	70619	R	Gas Ryder		⊖	69106	↔	Gas Ryder			
Vigo	(CGN25) (Rear Not suitable for RSA models)	05 on			†	G56218	↔	Safari		⊗	G56281	↔	Safari	NEW		
Vigo	(LAN25) (Both Not suitable for RSA models)	05 on			†	G56282	↔	Safari	NEW	⊗	G56281	↔	Safari	NEW		
Yaris	Hatch (Gen 3)	11 on			†	70802	L	Gas Ryder	NEW	⊖	62090	↔	Gas Ryder	NEW		
					†	70803	R	Gas Ryder	NEW	⊖	62090	↔	Gas Ryder	NEW		
Yaris	T3 1.3L (Mk II)	06-11			†	70608	L	Gas Ryder	NEW	⊖	G45890	↔	Technomatic			
					†	70609	R	Gas Ryder		⊖	G45890	↔	Technomatic			
Yaris	T1 1.0L, T3 1.3L (Mk II)	05-11			†	70608	L	Gas Ryder	NEW	⊖	G45890	↔	Technomatic			
					†	70609	R	Gas Ryder		⊖	G45890	↔	Technomatic			
Yaris	Vitz	99-05			†	70751	↔	Gas Ryder	NEW	⊖	62060	↔	Gas Ryder	NEW		
TRIUMPH																
Chicane	2000, 2500	65-78			†	44528	↔	Technomatic	OBS.	†	G45078	↔	Technomatic			
UNIMOG																
Buffel	414, 416 Truck	19.			⊗	76014	↔	Fleet Ryder		⊗	76014	↔	Fleet Ryder			
VOLKSWAGEN																
1500, 1600	Type 3 car	63-69			⊗	G45417	↔	Technomatic		⊗	G45419	↔	Technomatic			
411, 412	Type 4	69-75			†	44525	↔	Technomatic	OBS.	⊖	G45459	↔	Technomatic	OBS.		
Amarok	4x2	10 on			†	70759	↔	Gas Ryder	NEW	⊗	G56254	↔	Safari	NEW		
Amarok	4x4, 4x2 Raised	10 on			†	G570760	↔	Safari HDP	NEW	⊗	G578031	↔	Safari HDP	NEW		
					†	70759	↔	Gas Ryder	NEW	⊗	G56255	↔	Safari	NEW		



Model	Derivative	Year	Vehicle Type	Note # (pg 6)	FRONT					REAR					GASLIFT	
					Shock Info	Part #	Side	Range	Status	Shock Info	Part #	Side	Range	Status	Front	Rear
VOLKSWAGEN (CONT...)																
Beetle	Mk II	99-12			†	55872	↔	Gas Ryder		⊖	61262	↔	Gas Ryder			
Beetle	MK I	52-79		4	⊗	G45419	↔	Technomatic		⊗	G45419	↔	Technomatic			
					⊗	18727	↔	Technomatic		⊗	G45419	↔	Technomatic			
Caddy	All 50mm OD strut	04 on			†	70546	↔	Gas Ryder		⊗	62010	↔	Gas Ryder			
Caddy	All 55mm OD strut	04 on			†	70560	↔	Gas Ryder		⊗	62010	↔	Gas Ryder			
Caravelle	Caravelle T4	99-04			⊖	83373	↔	Heavy Duty		♀	83367	↔	Heavy Duty			
Citi	Sonic, Life & VeloCiti	98-11		9	†	55833	↔	Gas Ryder		†	69089	↔	Gas Ryder			4065
					†	35849	↔	Technomatic		†	69089	↔	Gas Ryder			
Citi	Incl. Chicco (Excl. Sonic, Life & VeloCiti)	84-11		9	†	55833	↔	Gas Ryder		†	69050	↔	Gas Ryder			4065
					†	35849	↔	Technomatic		†	51006	↔	Technomatic			
Citi Lowered Susp.	Incl. Chicco (Excl. Sonic, Life & VeloCiti)	84-11		9	†	L55833	↔	Gas Ryder		†	L69050	↔	Gas Ryder			4065
Crafter	3 ton, 3, 5 ton (Excl. 4x4 & 5 ton) (LT3)	06 on			†	70506	↔	Gas Ryder	NEW	⊗	62008	↔	Gas Ryder			
Fox	Incl. Shuttle	87-95		9	†	55833	↔	Gas Ryder		†	69050	↔	Gas Ryder			
					†	35849	↔	Technomatic		†	51006	↔	Technomatic			
Golf	Mk VI 50mm Strut Body (Excl. GTi)	09 on			†	70546	↔	Gas Ryder		⊖	61293	↔	Gas Ryder			
Golf	Mk VI 55mm Strut Body (Excl. GTi)	09 on			†	70560	↔	Gas Ryder		⊖	61293	↔	Gas Ryder			
Golf	Pick-up (Caddy I) (Sealed Strut)	93 on			†	55833	↔	Gas Ryder		⊗	G45877	↔	Technomatic			
Golf	Mk V 2.0 GTi	04-09			†	70581	↔	Gas Ryder		⊖	62002	↔	Gas Ryder			4312 4313
Golf	Mk V 50mm Strut Body (Excl. GTi)	04-09			†	70546	↔	Gas Ryder		⊖	61293	↔	Gas Ryder			4312 4313
Golf	Mk V 55mm Strut Body (Excl. GTi)	04-09			†	70560	↔	Gas Ryder		⊖	61293	↔	Gas Ryder			4312 4313
Golf	Mk IV 1.6 (Estate)	99-04			†	55881	↔	Gas Ryder		⊖	G45900	↔	Technomatic			
Golf	Mk IV 1.6 (Hatch with 20mm strut rod)	99-04			†	55881	↔	Gas Ryder		⊖	61262	↔	Gas Ryder			4314
Golf	Mk IV 1.8, GTi, 1.9 Tdi, 2.0, 2.3V5	99-04			†	55872	↔	Gas Ryder								
Golf	Mk IV 1.8, GTi, 1.9 Tdi, 2.0, 2.3V5 (with 22mm strut rod)	99-04			†	55872	↔	Gas Ryder		⊖	61262	↔	Gas Ryder			4314
Golf	Mk IV 1.9 Tdi (Estate)	99-04								⊖	G45900	↔	Technomatic			



V

Model	Derivative	Year	Vehicle Type	Note # (pg 6)	FRONT					REAR					GASLIFT	
					Shock Info	Part #	Side	Range	Status	Shock Info	Part #	Side	Range	Status	Front	Rear
VOLKSWAGEN (CONT...)																
Golf	Mk III All (Excl. cabriolet)	95-99		9	†	55841	↔	Gas Ryder		†	69068	↔	Gas Ryder			4082
Golf	Mk III GTi	94-99		9	†	55841	↔	Gas Ryder		†	69068	↔	Gas Ryder			4082
Golf	Mk III VR6	93-99		9	†	55841	↔	Gas Ryder		†	69068	↔	Gas Ryder			4082
Golf	Mk III (Excl. VR6 & Cabriolet)	93-94		9	†	55811	↔	Gas Ryder		†	69068	↔	Gas Ryder			4082
Golf	Pick-up (Caddy I) Incl. Sport (serviceable strut) (Typ 14)	81-93			/	44511	↔	Technomatic		⊗	G45877	↔	Technomatic			
Golf	Mk II All (Excl. Cabriolet)	84-92		9	†	55811	↔	Gas Ryder		†	69068	↔	Gas Ryder			4082
Golf	Mk II Lowered Susp.	84-92		9	†	L55811	↔	Gas Ryder		†	L69068	↔	Gas Ryder			4082
Golf	Mk I (local strut)	79-84		9	†	55833	↔	Gas Ryder		†	69050	↔	Gas Ryder			4065
					†	35849	↔	Technomatic		†	51006	↔	Technomatic			
					†	44511	↔	Technomatic		†	51006	↔	Technomatic			
Golf	Mk I Lowered Susp.	79-84		9	†	L55833	↔	Gas Ryder		†	L69050	↔	Gas Ryder			4065
Golf	Mk I (Imported strut)	78-79		9	†	35849	↔	Technomatic		†	69050	↔	Gas Ryder			4065
					†	35849	↔	Technomatic		†	51006	↔	Technomatic			
Golf Pick-Up (Caddy I)	Pickup (Sealed Strut)	93 on			†	35849	↔	Technomatic		⊗	G45877	↔	Technomatic			
Jetta	Mk VI (50mm OE Strut Body)	11 on			†	70774	↔	Gas Ryder	NEW	⊕	62018	↔	Gas Ryder	NEW		
Jetta	Mk VI (55mm OE Strut Body)	11 on			†	70775	↔	Gas Ryder	NEW	⊕	62018	↔	Gas Ryder	NEW		
Jetta	Mk V 50mm OE Strut Body (Excl. V5 & Sport Susp.)	06-11			†	70546	↔	Gas Ryder		⊕	62018	↔	Gas Ryder	NEW		
Jetta	Mk V 55mm OE Strut Body (Excl. V5 & Sport Susp.)	06-11			†	70560	↔	Gas Ryder		⊕	62018	↔	Gas Ryder	NEW		
Jetta	Mk IV (with 22mm strut rod)	99-06			†	55872	↔	Gas Ryder		⊕	61262	↔	Gas Ryder			
Jetta	Mk IV 1.6 (with 20mm strut rod)	99-06			†	55881	↔	Gas Ryder		⊕	61262	↔	Gas Ryder			
Jetta	Mk III	95-99		9	†	55841	↔	Gas Ryder		†	69068	↔	Gas Ryder			4501
Jetta	Mk III CLi	94-99		9	†	55841	↔	Gas Ryder		†	69068	↔	Gas Ryder			4501
Jetta	Mk III VR6	93-99		9	†	55841	↔	Gas Ryder		†	69068	↔	Gas Ryder			
Jetta	Mk III (Excl. VR6), Mk II	93-94		9	†	55811	↔	Gas Ryder		†	69068	↔	Gas Ryder			4501
Jetta	Mk II	85-92		9	†	55811	↔	Gas Ryder		†	69068	↔	Gas Ryder			
Jetta	Mk I (local strut)	79-85		9	†	55833	↔	Gas Ryder		†	69050	↔	Gas Ryder			
					†	35849	↔	Technomatic		†	51006	↔	Technomatic			
					†	44511	↔	Technomatic		†	51006	↔	Technomatic			
Jetta	Mk I (imported strut)	78-85		9	†	35849	↔	Technomatic		†	69050	↔	Gas Ryder			
					†	35849	↔	Technomatic		†	51006	↔	Technomatic			



Model	Derivative	Year	Vehicle Type	Note # (pg 6)	FRONT					REAR					GASLIFT	
					Shock Info	Part #	Side	Range	Status	Shock Info	Part #	Side	Range	Status	Front	Rear
VOLKSWAGEN (CONT...)																
Kombi	T5 TranSporter: Crew bus, Pickup & Panel van (Excl. 4-Motion)	05 on			f	70591	↔	Gas Ryder		⊗	62007	↔	Gas Ryder			
Kombi	T5 Kombi, Caravelle (Excl. 4-Motion)	04 on			f	70591	↔	Gas Ryder		⊗	62007	↔	Gas Ryder			
Kombi	T4 TranSporter: Mini bus, Pickup & Panel van Excl. syncro	99-04			⊕	83373	↔	Heavy Duty		♀	83367	↔	Heavy Duty			
Kombi	T3 Microbus (Excl. Synchro 4x4)	80-02		12	⊕	55227	↔	Safari		⊗	G56161	↔	Safari			4076
Kombi	T2 Microbus (double jointed axle rear)	68-80			⊗	G45417	↔	Technomatic		⊗	G45418	↔	Technomatic			
Kombi	T1/T2 Microbus, Fleetline (swing axle rear)	55-78			⊗	G45419	↔	Technomatic		⊗	G45419	↔	Technomatic			
					⊗	18727	↔	Technomatic		⊗	18727	↔	Technomatic			
Passat	B6 All (Excl. Sport Susp. & 4WD 4-Motion Syncro)	05-11			f	70560	↔	Gas Ryder								
Passat	1.6, 1.8, 1.8T, 2.0, 1.9TDI Excl. 4x4 (B5)	99-05			f	69087	↔	Gas Ryder		⊕	69946	↔	Gas Ryder			
Passat	2.3VR5 Excl. 4x4 (B5)	99-05			f	69087	↔	Gas Ryder		⊕	69946	↔	Gas Ryder			
Passat	2.8 V6 (B5)	99-05			f	69087	↔	Gas Ryder		⊕	69946	↔	Gas Ryder			
Passat	B5 2.3 V5 & 2.8 4WD 4-Motion Syncro	99-05			f	69087	↔	Gas Ryder								
Passat	B2	82-87		9	f	44602	↔	Technomatic		f	51016	↔	Technomatic		4067	4068
Passat	B1	74-81			f	44602	↔	Technomatic		⊗	G45715	↔	Technomatic			
Polo	Mk V (Typ 6R) (Excl. GTI)	10 on			f	70714	↔	Gas Ryder	NEW	⊕	G45879	↔	Technomatic			
Polo	Vivo (Mk IV)	10 on			f	70714	↔	Gas Ryder	NEW	⊕	G45879	↔	Technomatic			
Polo	Mk IV Excl. GTI	02-09			f	70503	↔	Gas Ryder		⊕	G45879	↔	Technomatic			
Polo	Playa (9N)	98-02		9	f	55841	↔	Gas Ryder		f	69081	↔	Gas Ryder			
Polo	Classic (Mk III)	96-02		9	f	55841	↔	Gas Ryder		f	69081	↔	Gas Ryder			4291
Sharan	Mk I, Mk IA, Mk IB	95-10			f	G35190	↔	Gas Ryder		⊗	69924	↔	Gas Ryder			
Touran	Typ 1T	04 on			f	70703	↔	Gas Ryder	NEW	⊕	69506	↔	Gas Ryder			



Model	Derivative	Year	Vehicle Type	Note # (pg 6)	FRONT					REAR					GASLIFT	
					Shock Info	Part #	Side	Range	Status	Shock Info	Part #	Side	Range	Status	Front	Rear
VOLVO																
122	Amazon	62-71			+	G45001	↔	Technomatic		⊗	G45054	↔	Technomatic			
122	Amazon, B18	59-71			+	G45001	↔	Technomatic		+	G56119	↔	Safari			
850	Excl. Self Levelling and Sport Susp.	94-97			f	G35128	↔	Gas Ryder		⊕	69901	↔	Gas Ryder			
850	Excl. Self Levelling and Sport Susp.	94-97			f	G35128	↔	Gas Ryder		⊕	69901	↔	Gas Ryder			
144, 164	B20E, B30	72-74			±	G45398	↔	Technomatic		⊗	45661	↔	Technomatic	OBS.		
144, 164	B20, B30	68-71		15	±	G45398	↔	Technomatic		⊗	45661	↔	Technomatic	OBS.		
B7F	Bus	19...			⊗	76042	↔	Fleet Ryder		⊗	76042	↔	Fleet Ryder			
C30	All	07 on			f	70633	L	Gas Ryder		⊕	62023	↔	Gas Ryder			
					f	70634	R	Gas Ryder		⊕	62023	↔	Gas Ryder			
C70	Excl. T5 (Mk I)	97-05			f	G35292	↔	Gas Ryder		⊕	69901	↔	Gas Ryder			
F12, FL12, FH12	Truck	19...			⊗	76008	↔	Fleet Ryder								
F88, G88	Truck	19...			⊗	76042	↔	Fleet Ryder								
S40	(MK II) Incl. T5	04-11			f	70633	L	Gas Ryder		⊕	62023	↔	Gas Ryder			
					f	70634	R	Gas Ryder		⊕	62023	↔	Gas Ryder			
S40	MK II Incl. T5	04-11			f	70633	L	Gas Ryder		⊕	62023	↔	Gas Ryder			
					f	70634	R	Gas Ryder		⊕	62023	↔	Gas Ryder			
S40	(Mk I) Excl. & T4 rear	00-04			f	70683	L	Gas Ryder		⊕	69110	↔	Gas Ryder			
					f	70684	R	Gas Ryder		⊕	69110	↔	Gas Ryder			
S40	(Mk I) Excl. & T4 rear	95-00			f	G35220	L	Gas Ryder		f	G51269	↔	Gas Ryder			
					f	G35225	R	Gas Ryder		f	G51269	↔	Gas Ryder			
S60	Sedan	00-10			f	70785	↔	Gas Ryder	NEW	⊕	62082	↔	Gas Ryder	NEW		
S70, V70	Excl. &	97-00			f	G35292	↔	Gas Ryder		⊕	69901	↔	Gas Ryder			
WESTERN STAR																
3842S	Truck	19...		26	⊗	76042	↔	Fleet Ryder								
					⊗	76017	↔	Fleet Ryder								
4842S, 4864S	Truck	19...		26	⊗	76042	↔	Fleet Ryder								
					⊗	76017	↔	Fleet Ryder								
5964F, 5964F	Truck	19...		26	⊗	76042	↔	Fleet Ryder								
					⊗	76017	↔	Fleet Ryder								



PARTS LISTING – SHOCKS, STRUTS & CARTRIDGES

The Parts Listing highlights our products in alpha numerical order according to their part number. This Allows for easy reference to the applicable make and model of the vehicles when finding an application or applications which use that Gabriel part number.

Part numbers marked as OBS. are obsolete or in the process of being phased out and a superseding part number is listed.

The product ranges for each part number is indicated. For more detailed information on the Gabriel ranges, please refer to pages 8-10. For product dimensions and end-mountings refer to the Technical Section starting from page 161.

Some Gabriel Europe imports are stamped with a manufacturing number and are not listed in this section and these will be found in our Parts Finder section starting from page 137.



14004

PARTS LISTING

Shocks & Struts

14004 – 35830

Part #	Range	Superceding Part #/Status.	Product Type	Make	Model	Derivative	Year	Position	L/R	Note # (pg 6)
14004	Steering Damper			Volkswagen	Beetle	All	52-79	Front		
14011	Steering Damper			Land Rover	Range Rover	SUV	76-94	Front		
				Land Rover	Range Rover, Discovery	SUV	76-98	Front		
14012	Steering Damper			Audi	100, 200	PC	81-84	Front		
				Isuzu	KB, TF Series	4X2, 4X4	81-03	Front		
14013	Steering Damper			Land Rover	Defender	109", 110" WB, Series 11, 111	65-84	Front		
14014	Steering Damper			Opel	Commodore, Rekord	Incl. 2500, 3800, 4100	78-97	Front		
14016	Steering Damper	OBS.		Ford	F Series	F250 4X4	68-77	Front		
14017	Steering Damper	OBS.		Chevrolet	K Series 4X4	K10, K20, K25	74-83	Front		
14021	Steering Damper			Toyota	Hilux	4X4	79-98	Front		
14022	Steering Damper			Nissan	Patrol	4X4	82-90	Front		
				Nissan	Safari	SUV	82-90	Front		
14023	Steering Damper			Toyota	Landcruiser	FJ45, BJ45	71-85	Front		
14024	Steering Damper			Toyota	Landcruiser	FJ62, BJ60, BJ75	83-99	Front		
				Toyota	Landcruiser	HZJ 80	90-98	Front		
14032	Steering Damper			Land Rover	Defender	90, 110, 130 (Incl. Defender, County)	84-07	Front		
14033	Steering Damper			Toyota	Hilux	4X4	99-05	Front		
14040	Steering Damper			Jeep (Chrysler)	Jeep	Cherokee	93-01	Front		
18727	Technomatic			Volkswagen	Beetle	Mk I	52-79	Front	↔	4
				Volkswagen	Kombi	Microbus, Fleetline (swing axle rear)	55-78	Front	↔	
				Volkswagen	Kombi	Microbus, Fleetline (swing axle rear)	55-78	Rear	↔	
19021	Technomatic			Austin, Morris	Mini	Excl. Hydrolastic Susp.	59-85	Front	↔	
				Austin, Morris	Mini	Incl. Cooper	59-80	Front	↔	
				Austin, Morris	Mini	Incl. Mk III	61-79	Front	↔	
19022	Technomatic			Renault	R8, R10	Small Sedan	62-70	Front	↔	
				Austin, Morris	Mini	Excl. Hydrolastic Susp.	59-85	Rear	↔	
				Austin, Morris	Mini	Incl. Cooper	59-80	Rear	↔	
				Austin, Morris	Mini	Incl. Mk III	61-79	Rear	↔	
				Renault	R8, R10	Small Sedan	62-70	Rear	↔	
19289	Technomatic			Nissan	Langley, Pulsar	Incl. Panache (N10)	80-83	Rear	↔	
19290	Technomatic			Toyota	1200	LDV	78-82	Rear	↔	
35117	Technomatic			Renault	Laguna	I (Excl. Station Wagon)	96-00	Front	↔	
35816	Technomatic			Ford	Bantam	1300, 1600	83-86	Front	↔	
				Ford	Escort	Mk III FWD L, GL, GLE	81-86	Front	↔	
				Ford	Escort	Mk III FWD XR3, Sport	81-86	Front	↔	
				Mazda	Rustler	130, 160	85-86	Front	↔	
35817	Technomatic			Ford	Escort	Mk III FWD L, GL, GLE	81-86	Rear	↔	
				Ford	Escort	Mk III FWD XR3, Sport	81-86	Rear	↔	
35824	Technomatic			Renault	R9, R11	Saloon, Hatchback	83-86	Front	↔	
35830	Technomatic			Honda	Ballade	Civic	82-84	Front	↔	

PARTS LISTING

Shocks & Struts

35831



35831 - 35922

Part #	Range	Superceding Part #/Status.	Product Type	Make	Model	Derivative	Year	Position	L/R	Note # (pg 6)
35831	Technomatic		f 1.1	Honda	Ballade	Civic	82-84	Rear	↔	
35832	Technomatic		f 1.1	Ford	Laser, Meteor, Tracer	KC/KE, GC	86-91	Front	↔	
				Mazda	323	Incl. S (non sealed strut)	81-83	Front	↔	
				Mazda	323	Incl. S, EGi, Sport	82-91	Front	↔	
35833	Technomatic		f 1.1	Ford	Laser, Meteor, Tracer	KC/KE, GC	86-91	Rear	↔	
				Ford	Laser, Meteor, Tracer	KF/KH	91-01	Rear	↔	
				Mazda	323	Incl. Midge	91-04	Rear	↔	
				Mazda	323	Incl. S (non sealed strut)	81-83	Rear	↔	21
				Mazda	323	Incl. S, EGi, Sport	82-91	Rear	↔	
35834	Technomatic	55806	f 1.1	Mazda	626	Incl. Coupe (Mk II, Mk III)	83-92	Front	↔	
35836	Technomatic		f 1.1	Mitsubishi	Tredia	Excl. Turbo	83-86	Front	↔	
35842	Technomatic		f 1.1	Ford	Sierra, Sapphire	2300, 2000, 1600	83-93	Front	↔	
				Ford	Sierra, Sapphire	3000 (Incl. XR6)	83-93	Front	↔	
				Ford	Sierra, Sapphire	Estate	83-93	Front	↔	
35843	Technomatic	55810	f 1.1	Honda	Ballade	130, 150, 150i (SC9) (Civic)	84-87	Front	↔	
35844	Technomatic		f 1.1	Ford	Bantam	1400, 1600	86-94	Front	↔	
				Mazda	Rustler	1400, 1600	86-94	Front	↔	
35845	Technomatic	55812	f 1.1	Toyota	Conquest	FWD (E80)	85-89	Front	↔	
				Toyota	Corolla	FWD (Incl. Avante) (E80)	85-89	Front	↔	
35846	Technomatic	55813	f 1.1	Toyota	Conquest	FWD (E80)	85-89	Rear	↔	
				Toyota	Corolla	FWD (Incl. Avante) (E80)	85-89	Rear	↔	
35847	Technomatic		f 1.1	Nissan	Langley, Pulsar	Incl. Exa (sealed strut) (N12)	83-88	Front	↔	
35848	Technomatic		f 1.1	Ford	Laser, Meteor, Tracer	KF/KH	91-01	Front	↔	
				Mazda	323	Incl. Midge	91-04	Front	↔	
35849	Technomatic		f 1.1	Volkswagen	Citi	Incl. Chicco (Excl. Sonic, Life & VeloCiti)	84 on	Front	↔	
				Volkswagen	Citi	Sonic, Life & VeloCiti	98 on	Front	↔	
				Volkswagen	Fox	Incl. Shuttle	87-95	Front	↔	
				Volkswagen	Golf	Mk I (Imported strut)	78-79	Front	↔	
				Volkswagen	Golf	Mk I (local strut)	79-84	Front	↔	
				Volkswagen	Golf	Pick-up (sealed strut)	93-03	Front	↔	
				Volkswagen	Jetta	Mk I (Imported strut)	78-85	Front	↔	
				Volkswagen	Jetta	Mk I (local strut)	79-85	Front	↔	
35868	Technomatic	OBS.	f 1.1	Fiat	131	Supermirafiori, Superstrada	79-81	Front	↔	
				Fiat	132	Supermirafiori	79-81	Front	↔	
35916	Technomatic	55816	f 1.1	Nissan	Sentra	Sedan, Coupe (B12)	87-92	Front	↔	
35917	Technomatic	55817	f 1.1	Nissan	Sentra	Sedan, Coupe (B12)	87-92	Rear	↔	
35920	Technomatic	55854	f 1.1	Fiat	Uno	Incl. Turbo (Series 2)	90-06	Front	↔	
35922	Technomatic	55811	f 1.1	Volkswagen	Golf	Mk III (Excl. VR6 & Cabriolet), Mk II All (Excl. Cabriolet)	93-94	Front	↔	
				Volkswagen	Jetta	Mk III (Excl. VR6), Mk II	93-94	Front	↔	



35923

PARTS LISTING

Shocks & Struts

35923 – 36760

Part #	Range	Superceding Part #/Status.	Product Type	Make	Model	Derivative	Year	Position	L/R	Note # (pg 6)	
35923	Technomatic	55838	J	1.1	Nissan	Sabre	160, 200 (Excl. ABS)	92-01	Front	L	
					Nissan	Sentra	140	92-01	Front	L	
					Nissan	Sentra	160, 200 (Excl. STi)	92-01	Front	L	
35924	Technomatic	55839	J	1.1	Nissan	Sabre	160, 200 (Excl. ABS)	92-01	Front	R	
					Nissan	Sentra	140	92-01	Front	R	
					Nissan	Sentra	160, 200 (Excl. STi)	92-01	Front	R	
35925	Technomatic	55840	J	1.1	Nissan	Sentra	140	92-01	Rear	←→	
35926	Technomatic	55841	J	1.1	Volkswagen	Golf	Mk III All (Excl. Cabriolet)	95-99	Front	←→	
					Volkswagen	Golf	Mk III GTi	94-99	Front	←→	
					Volkswagen	Jetta	Mk III	95-99	Front	←→	
					Volkswagen	Jetta	Mk III Cli	94-99	Front	←→	
					Volkswagen	Polo	Classic (Mk III)	96-02	Front	←→	
					Volkswagen	Polo	Playa (9N)	98-02	Front	←→	
35927	Technomatic		J	1.1	Ford	Bantam	1300, 1600	94-02	Front	←→	
					Mazda	Rustler	1300, 1600	94-02	Front	←→	
35934	Technomatic		J	1.1	Tata	Indica	1.4 Hatch (V2) (Incl. B-Line, Excl. TDi & ABS)	04 on	Front	L	
35935	Technomatic		J	1.1	Tata	Indica	1.4 Hatch (V2) (Incl. B-Line, Excl. TDi & ABS)	04 on	Front	R	
35936	Technomatic	OBS.	J	1.1	Tata	Indigo	1.4 Sedan & Station Wagon	04 on	Front	L	
35937	Technomatic	OBS.	J	1.1	Tata	Indigo	1.4 Sedan & Station Wagon	04 on	Front	R	
35938	Technomatic	OBS.	J	1.1	Tata	Indigo	1.4 Sedan & Station Wagon	04 on	Rear	L	
35939	Technomatic	OBS.	J	1.1	Tata	Indigo	1.4 Sedan & Station Wagon	04 on	Rear	R	
35941	Technomatic		J	1.1	Chevrolet	Aveo	T200 (Kalos)	02 on	Front	L	
35942	Technomatic		J	1.1	Chevrolet	Aveo	T200 (Kalos)	02 on	Front	R	
35943	Technomatic		J	1.1	Kia	Clarus	2.0 GLX (Credos)	98-06	Front	L	
35944	Technomatic		J	1.1	Kia	Clarus	2.0 GLX (Credos)	98-06	Front	R	
35945	Technomatic		J	1.1	Kia	Clarus	2.0 GLX (Credos)	98-06	Rear	L	
35946	Technomatic		J	1.1	Kia	Clarus	2.0 GLX (Credos)	98-06	Rear	R	
35951	Technomatic		J	1.1	Hyundai	Atoz	Incl. Prime (Mk II)	99 on	Front	L	
35952	Technomatic		J	1.1	Hyundai	Atoz	Incl. Prime (Mk II)	99 on	Front	R	
35953	Technomatic		J	1.1	Chana	Star	Bakkie, Panel van, Minibus (Incl. Maxi Star)	06 on	Front	L	
35954	Technomatic		J	1.1	Chana	Star	Bakkie, Panel van, Minibus (Incl. Maxi Star)	06 on	Front	R	
35955	Technomatic	NEW	J	1.1	Chery	QQ3	Hatch	08 on	Front	L	
35956	Technomatic	NEW	J	1.1	Chery	QQ3	Hatch	08 on	Front	R	
36759	Technomatic	61201	1/5	7.1	Mercedes-Benz	114, 115 Series	220, 230, 240D, 280E, 280 (Excl. )	68-77	Front	←→	
36760	Technomatic	OBS.	1/5	7.1	Mercedes-Benz	110 Series	190, 200, 230	62-67	Front	←→	
					Mercedes-Benz	111 Series	220, 250, 280	60-68	Front	←→	
					Mercedes-Benz	S Class	108 Series	68-73	Front	←→	

PARTS LISTING

Shocks & Struts

36761



Part #	Range	Superceding Part #/Status.	Product Type	Make	Model	Derivative	Year	Position	L/R	Note # (pg 6)	
36761	Technomatic		1/2	6.1	Mercedes-Benz	110 Series	190, 200, 230	62-67	Rear	↔	
					Mercedes-Benz	111 Series	220, 250, 280	60-68	Rear	↔	
					Mercedes-Benz	S Class	108 Series	68-73	Rear	↔	
36764	Technomatic	OBS.	1/4	5	Renault	R12	Saloon, Estate	71-75	Rear	↔	
36767	Technomatic		1/2	6.2	Nissan	Y Series	1200	71-75	Rear	↔	
					Nissan	Y Series	120Y, 140 SDX, (12" wheels)	75-80	Rear	↔	
					Nissan	Y Series	140 SDX (13" wheels), 140Y, 160Y	75-80	Rear	↔	
36826	Technomatic	OBS.	1/2	6.2	Audi	100, 200	Excl. Coupe (C1)	75-77	Front	↔	
36844	Technomatic	OBS.	1/2	6.2	Audi	100, 200	Excl. Coupe (C1)	72-74	Front	↔	
36847	Technomatic	61202	1/8	7.1	Mercedes-Benz	C Class	(W123) 200, 230E, 240D, 250, 280E, 300D (Excl. ①)	77-86	Front	↔	
					Mercedes-Benz	S Class	(116 Series) 280SE, 280S, 350SE (Excl. ①)	73-81	Front	↔	
					Mercedes-Benz	S Class	(W126) 280SE, 300SE, 380SE, 420SE, 500SE, 560SE Incl. SEL & SEC (Excl. ①)	81-93	Front	↔	
36849	Technomatic	OBS.	1/2	6.2	Alfa-Romeo	Alfasud, Export, Sprint	Excl. sealed strut	74-85	Rear	↔	
					Alfa-Romeo	Export	Panel van	80-85	Rear	↔	
36850	Technomatic		1/2	6.2	Renault	R5	Mk I Hatchback	72-85	Front	↔	
					Renault	R5	Mk I Panel van	80-85	Front	↔	
36851	Technomatic		1/2	6.2	Renault	R5	Mk I Hatchback	72-85	Rear	↔	
					Renault	R5	Mk I Panel van	80-85	Rear	↔	
					Renault	R9, R11	Saloon, Hatchback	83-86	Rear	↔	
36853	Technomatic		1/2	6.2	Audi	100, 200	C2	77-84	Rear	↔	14
36854	Technomatic		1/2	6.2	Audi	100, 200	Excl. Coupe (C1)	72-74	Rear	↔	
					Audi	100, 200	Excl. Coupe (C1)	75-77	Rear	↔	
					Ford	Capri	Mk I	69-73	Rear	↔	
					Ford	Corsair	1.6	64-66	Rear	↔	
					Ford	Corsair	1.6, 2.0	66-69	Rear	↔	
					Ford	Cortina	Mk I	64-66	Rear	↔	
					Ford	Cortina	Mk II	67	Rear	↔	
					Ford	Cortina	Mk II	68-70	Rear	↔	
					Hillman	Vogue, Hunter	Incl. Sceptre, Arrow	67-77	Rear	↔	
Nissan	Stanza	1600J, 1800J Stanza, Resort (A10)	78-83	Rear	↔						
36855	Technomatic	OBS.	1/2	6.2	Alfa-Romeo	33	1.2, 1.3, 1.5, 1.7	83-85	Rear	↔	
36857	Technomatic		1/2	6.2	BMW	2 Series	1502, 2002 Ti Lux (E10)	66-77	Rear	↔	
					BMW	3 Series	E30 Series (Excl. iS & Cabriolet)	83-91	Rear	↔	14
36859	Technomatic	G56185	1/2	4	Isuzu	WFR, Relay	Fargo	80-95	Front	↔	
					Mitsubishi	Colt Bakkie	L200 (2.6, 3.0, V6 4X4, 4X2 Raised height)	94-98	Front	↔	
					Toyota	Stallion	KF40	87-00	Front	↔	
					Toyota	Venture	KF40	91-00	Front	↔	
					Mitsubishi	Colt Bakkie	L200 (1.6, 2.0, 2.5D 4X2)	94-98	Front		
Mitsubishi	Colt Bakkie	L200 (4X2 Std. height)	98-07	Front							

36761 - 36859



36860

PARTS LISTING

Shocks & Struts

36860 - 42864

Part #	Range	Superceding Part #/Status.	Product Type	Make	Model	Derivative	Year	Position	L/R	Note # (pg 6)
36860	Technomatic		☉ 8.5	Tata	Telcoline	4X4, 4X2	04 on	Rear	↔	
36862	Technomatic	G45886	☉ 8.4	Mahindra	Scorpio	4X2	05 on	Rear	↔	
				Mahindra	Scorpio	4X4	05 on	Rear	↔	
36863	Technomatic		☉ 8.5	Tata	LPT 509M 4X2 F-C	Truck	19..	Front	↔	
				Tata	SFC 407 2T 4X2 F-C	Truck	19..	Front	↔	
36865	Technomatic		☽ 6.1	Toyota	Rav4	Sealed struts (XA10)	98-00	Rear	↔	
				Toyota	Rav4	Serviceable struts (XA10)	96-98	Rear	↔	
36866	Technomatic		☽ 6.2	Chevrolet	Aveo	T200 (Kalos)	02 on	Rear	↔	
36867	Technomatic		☉ 8.5	Hyundai	Atoz	Incl. Prime (Mk II)	99 on	Rear	↔	
36868	Technomatic		☽ 6.2	Toyota	Dyna	4-093 4X2 F-C	02 on	Front	↔	
36869	Technomatic		☉ 8.3	Toyota	Dyna	4-093 4X2 F-C	02 on	Rear	↔	
36870	Technomatic		☽ 6.1	Toyota	Dyna	7-094	89-00	Front	↔	
				Toyota	Dyna	7-095 F-C	89-00	Front	↔	
				Toyota	Dyna	7-095 4X2 (ADE364C)	89-00	Front	↔	
36871	Technomatic		☉ 8.2	Toyota	Dyna	7-094	89-00	Rear	↔	
				Toyota	Dyna	7-095 F-C	89-00	Rear	↔	
				Toyota	Dyna	7-095 4X2 (ADE364C)	89-00	Rear	↔	
36872	Technomatic		☉ 8.2	Toyota	Dyna	5-103	08 on	Front	↔	
36873	Technomatic		☉ 8.2	Dyna	7-105 LWB 4T 4x2 F-C	Dyna 7-095 4X2 (ADE364C)	89-00	Rear	↔	
				Toyota	Dyna	6-104 4X2	03 on	Rear	↔	
36874	Technomatic		☉ 8.2	Toyota	Dyna	6-104 4X2	96-03	Rear	↔	
36875	Technomatic	NEW	☉ 8.5	Chery	QQ3	Hatch	08 on	Rear	↔	
36876	Technomatic	NEW	☽ 6.1	Toyota	Ipsum	(SM10)	96-01	Rear	↔	
42155	Technomatic	OBS.	☽ 6	Fiat	124	Excl. Station Wagon	69-77	Front	↔	
42282	Technomatic	OBS.	☽ 6	Fiat	125	Sedan	69-75	Front	↔	
				Fiat	132	Incl. Elita	75-81	Front	↔	
42314	Technomatic	OBS.	† 5	Renault	R12	Saloon, Estate	71-75	Rear	↔	
42447	Technomatic	OBS.	♀ 9.2	Austin, Morris	Marina	1.3, 1.5, 1.7	73-79	Rear	↔	
42575	Technomatic	OBS.	☉ 8.5	Suzuki	Carry	Mk VIII	82-85	Rear	↔	
42772	Technomatic		☉ 8.5	Iveco	Daily	49.10, 49.12, 59.12	19..	Front	↔	
				Iveco	Daily, Turbo Daily	35.10V, 45.10, A45.10, 40.10, 49.12, 59.12	95-00	Front	↔	
				Iveco	Daily, Turbo Daily	45.10, A45.10, 49.10	95-00	Front	↔	
				Iveco	Daily	49.10, 49.12, 59.12	19..	Rear	↔	
				Iveco	Daily, Turbo Daily	45.10, A45.10, 49.10	95-00	Rear	↔	
42773	Technomatic		☉ 8.5	Iveco	Daily, Turbo Daily	35.10V, 45.10, A45.10, 40.10, 49.12, 59.12	95-00	Rear	↔	
				Iveco	Turbo Daily	42.12, 45.12, 54.12, 66.12	19..	Rear	↔	
42826	Technomatic	OBS.	☉ 8.5	Renault	Laguna	I (Excl. Station Wagon)	96-00	Rear	↔	
42864	Technomatic		☉ 8.5	Mercedes-Benz	Sprinter	308D, 312D (903)	95 on	Rear	↔	
				Mercedes-Benz	Sprinter 308D	Truck	96 on	Rear	↔	
				Mercedes-Benz	Sprinter 312D	Truck	96 on	Rear	↔	

PARTS LISTING

Shocks & Struts

42942



42942 - 44510

Part #	Range	Superceding Part #/Status.	Product Type	Make	Model	Derivative	Year	Position	L/R	Note # (pg 6)	
42942	Technomatic	G56268	⊗	8.5	Mercedes-Benz	Vito	115 CDI 2.2 Bus MPV Diesel (W639)	04 on	Rear	↔	
					Mercedes-Benz	Vito	115 CDI 2.2 Cr-Cab Panel Van Diesel (W639)	04 on	Rear	↔	
					Mercedes-Benz	Vito	115 CDI 2.2 Panel Van Diesel (W639)	04 on	Rear	↔	
44085	Technomatic		/	2	BMW	3 Series	E30 Series (Excl. iS & Cabriolet)	83-90	Front	↔	
44216	Technomatic	OBS.	/	2	Mazda	1200, 1300	Familia (Mk II)	72-75	Front	↔	
44217	Technomatic		/	2	Nissan	1/2 Ton Bakkie	120Y (12" wheels)	76-83	Front	↔	
					Nissan	1/2 Ton Bakkie	1400, 1200, 120Y	71-08	Front	↔	
					Nissan	Y Series	1200	71-75	Front	↔	
					Nissan	Y Series	1200	72-75	Front	↔	
					Nissan	Y Series	120Y, 140 SDX, (12" wheels)	75-80	Front	↔	
44220	Technomatic	OBS.	/	2	Toyota	Corolla Carri	Imported strut	73-79	Front	↔	
44221	Technomatic	OBS.	/	2	Fiat	128	LDV	73-84	Front	↔	
					Fiat	128	Local struts	71-81	Front	↔	
44222	Technomatic	OBS.	/	2	Fiat	128	LDV	73-84	Rear	↔	
					Fiat	128	local struts	71-81	Rear	↔	
44224	Technomatic	OBS.	/	2	Fiat	133	Mirafiori	77-78	Front	↔	
44225	Technomatic	OBS.	/	2	Mazda	323	RWD (Imported strut)	77-78	Front	↔	
44226	Technomatic		/	2	Toyota	1200	LDV	78-82	Front	↔	
44227	Technomatic		/	2	Nissan	Langley, Pulsar	Incl. Panache (N10)	80-83	Front	↔	
44411	Technomatic		/	2	Opel	Astra	Estate (F)	94-01	Front	↔	
					Opel	Astra	F	93-99	Front	↔	
					Opel	Kadett	Astra	93-99	Front	↔	
44500	Technomatic		/	2	Nissan	U Series	1600, 1800 (Incl. Coupe)	72-73	Front	↔	
					Nissan	U Series	160U, 180U	74-78	Front	↔	
44502	Technomatic	OBS.	/	2	Dodge (Chrysler)	Colt	1600, 2000	72-77	Front	↔	
					Mitsubishi	Colt	Dodge 1600, 2000, (Incl. Coupe)	72-77	Front	↔	
					Mitsubishi	Colt	Galant (Imported strut)	77-78	Front	↔	
44505	Technomatic		/	2	Ford	Escort	Mk I	68-73	Front	↔	
					Ford	Escort	Mk I 1100, 1300	70-75	Front	↔	
					Ford	Escort	Mk I, II	74-81	Front	↔	
					Ford	Escort	Mk II	75-81	Front	↔	17
44509	Technomatic	OBS.	/	2	Peugeot	404	Estate	69-78	Front	↔	
					Peugeot	404	LDV	60-81	Front	↔	
					Peugeot	404	Saloon	60-78	Front	↔	
44510	Technomatic		/	2	Nissan	1/2 Ton Bakkie	1400 (13" wheels)	80-83	Front	↔	
					Nissan	Stanza	1600J, 1800J Stanza, Resort (A10)	78-83	Front	↔	
					Nissan	Stanza	1600J, 1800J, Stanza Station Wagon (A10)	79-83	Front	↔	
					Nissan	Y Series	140 SDX (13" wheels), 140Y, 160Y	75-80	Front	↔	
					Nissan	Y Series	140Y, 160Y	75-80	Front	↔	
					Nissan	Y Series	140Y, 160Y	75-80	Front	↔	



44511

PARTS LISTING

Shocks & Struts

44511 - 44607

Part #	Range	Superceding Part #/Status.	Product Type	Make	Model	Derivative	Year	Position	L/R	Note # (pg 6)
44511	Technomatic		/ 2	Volkswagen	Golf	Incl. Sport (serviceable strut) (Typ 14)	81-93	Front	↔	
				Volkswagen	Golf	Mk I (local strut)	79-84	Front	↔	
				Volkswagen	Jetta	Mk I (local strut)	79-85	Front	↔	
44514	Technomatic	OBS.	/ 2	Ford	Cortina	Mk II	68-70	Front	↔	
44516	Technomatic		/ 2	Ford	Capri	Mk I	69-73	Front	↔	
				Ford	Escort	Mk I 1600, GT	70-75	Front	↔	
44525	Technomatic	OBS.	/ 2	Volkswagen	411, 412	Type 4	69-75	Front	↔	
44528	Technomatic	OBS.	/ 2	Triumph	Chicane	2000, 2500	65-78	Front	↔	
44529	Technomatic	OBS.	/ 2	Dodge (Chrysler)	Husky	LDV	74-78	Front	↔	
				Hillman	Vogue, Hunter	Incl. Sceptre, Arrow	67-77	Front	↔	
				Hillman	Vogue, Hunter	Safari	67-77	Front	↔	
44532	Technomatic	OBS.	/ 2	Mazda	616	Incl. Capella, RX2	70-79	Front	↔	
44535	Technomatic		/ 2	Mazda	323	RWD (local strut)	78-81	Front	↔	
44554	Technomatic	55811	/ 1.1	Volkswagen	Golf	Mk II (serviceable strut)	84-92	Front	↔	
				Volkswagen	Jetta	Mk II	85-92	Front	↔	
44559	Technomatic	OBS.	/ 2	Ford	Corsair	1.6	64-66	Front	↔	
				Ford	Cortina	Mk I	64-66	Front	↔	
44564	Technomatic	OBS.	/ 2	Peugeot	305	Series 1	79-82	Front	↔	
				Peugeot	305	Series 2	83-85	Front	↔	11
44601	Technomatic		/ 2	BMW	5 Series	E12 Series	74-76	Front	↔	
				BMW	5 Series	E12 Series	76-85	Front	↔	18
44602	Technomatic		/ 2	Audi	80	B1	75-81	Front	↔	
				Volkswagen	Passat	B1	74-81	Front	↔	
				Volkswagen	Passat	B2	82-87	Front	↔	
44603	Technomatic		/ 2	Toyota	Cressida	MX63 (Mk II)	81-93	Front	↔	
				Toyota	Cressida	Non IRS+, MX63 (Mk II)	81-93	Front	↔	
				Toyota	Cressida	With IRS+, MX73 (Mk III)	83-93	Front	↔	
44604	Technomatic		/ 2	Peugeot	504	GL, GLD, Ti	73-80	Front	↔	
				Peugeot	504	L, GR	76-85	Front	↔	
44606	Technomatic		/ 2	Peugeot	504	Estate	74-85	Front	↔	
				Peugeot	505	Saloon	80-85	Front	↔	
44607	Technomatic		/ 2	Daewoo	Cielo	Nexia	95-98	Front	↔	
				Daewoo	Espero	Aranos	95-98	Front	↔	
				Daewoo	Lanos	Sens	97-03	Front	↔	
				Opel	Kadett	D	80-85	Front	↔	
				Opel	Kadett	Estate (D)	80-85	Front	↔	
				Opel	Kadett	T-car (E)	85-89	Front	↔	
				Opel	Kadett	T-car (E)	89-93	Front	↔	
				Opel	Monza	Incl. Cub	89-93	Front	↔	
Opel	Monza	Incl. GSi	86-89	Front	↔					

PARTS LISTING

Shocks & Struts

44608



Part #	Range	Superceding Part #/Status.	Product Type	Make	Model	Derivative	Year	Position	L/R	Note # (pg 6)
44608	Technomatic		/ 2	Nissan	Laurel	C230	78-87	Front	↔	
				Nissan	Skyline	1800, 2000 (R30)	82-87	Front	↔	
				Nissan	Skyline	2800 GLX, GTX (R30)	82-87	Front	↔	
44609	Technomatic	OBS.	/ 2	Toyota	Cressida	X30, X32 (Imported strut) (Mk I)	77-79	Front	↔	
				Toyota	Cressida	X35, X36 (Imported strut) (Mk I)	78-79	Front	↔	
44611	Technomatic		/ 2	Opel	Commodore	C	78-88	Front	↔	
				Opel	Commodore	C	78-92	Front	↔	
				Opel	Rekord	380i V6	91-97	Front	↔	
				Opel	Rekord	Caravan (E)	78-92	Front	↔	
				Opel	Rekord	Sedan (Excl. V6) (E)	78-97	Front	↔	
				Opel	Senator	A	79-86	Front	↔	
44612	Technomatic		/ 2	Mitsubishi	Colt	Galant (local strut)	78-83	Front	↔	
44613	Technomatic		/ 2	Toyota	Cressida	X30, X32 (local strut) (Mk I)	79-81	Front	↔	
				Toyota	Cressida	X35, X36 (local strut) (Mk I)	79-81	Front	↔	
44614	Technomatic		/ 2	Toyota	Corolla	Imported strut (E30, E40, E50, E60)	74-80	Front	↔	10
				Toyota	Corolla	Imported strut (E30, E40, E50, E60)	82-85	Front	↔	
				Toyota	Corolla	RWD (Excl. Van, Station Wagon) (E70)	80-85	Front	↔	
				Toyota	Corolla Carri	local strut (E30, E40, E50, E60)	79-89	Front	↔	
44615	Technomatic		/ 2	Chevrolet / Opel	Ascona, Chevaïr	Incl. Coupe (C)	82-85	Front	↔	
44616	Technomatic	61915	/ 2	Nissan	Skyline	R31	87-92	Front	↔	
44858	Technomatic	OBS.	/ 2	Alfa-Romeo	Alfasud, Export, Sprint	Excl. sealed strut	74-85	Front	↔	
				Alfa-Romeo	Export	Panel van	80-85	Front	↔	
44874	Technomatic	OBS.	/ 2	Ford	Taurus	17M, 20M	61-73	Front	↔	
44933	Technomatic	OBS.	/ 2	Chevrolet / Opel	Ascona, Chevaïr	Incl. Coupe (short strut) (C)	84-86	Front	↔	
45164	Technomatic	OBS.	1/3 7.2	Ford	Laser, Meteor, Tracer	Familia	69-76	Front	↔	
				Ford	Ranchero	Falcon	69-76	Front	↔	
				Rambler	Hornet & Sportabout	AMC	70-76	Front	↔	
45171	Technomatic	81469	1/3 6.2	Chrysler	Valiant	Incl. Dodge SE, Chrysler L	60-81	Front	↔	
				Chrysler	Valiant	Rustler	72-78	Front	↔	
45172	Technomatic	OBS.	3/8 8.2	Chrysler	Valiant	Incl. Dodge SE, Chrysler L	60-81	Rear	↔	
				Chrysler	Valiant	Rustler	72-78	Rear	↔	
45257	Technomatic	OBS.	1/2 5	Volvo	122	Amazon, B18	59-71	Rear	↔	
45410	Technomatic	OBS.	1/3 6.2	Fiat	124	Station Wagon	69-77	Front	↔	
45436	Technomatic	OBS.	1/3 6.2	Fiat	124	Excl. Station Wagon	69-77	Rear	↔	
				Fiat	131	Supermirafiori, Superstrada	79-81	Rear	↔	
				Fiat	133	Mirafiori	77-78	Rear	↔	
45464	Technomatic	OBS.	1/2 5	Alfa-Romeo	Other	Incl. Giulia	66-77	Rear	↔	
45495	Technomatic	OBS.	1/3 6.2	Mazda	RX7	Coupe	81-85	Rear	↔	
45661	Technomatic	OBS.	3/8 8.4	Volvo	144, 164	B20, B30	68-71	Rear	↔	
				Volvo	144, 164	B20E, B30	72-74	Rear	↔	

44608 - 45661



Part #	Range	Superceding Part #/Status.	Product Type	Make	Model	Derivative	Year	Position	L/R	Note # (pg 6)
45702	Technomatic	OBS.	⊕ 6.2	Chevrolet / Opel	Ascona, Chevaïr	B, (Mk I Cavalier)	76-82	Front	↔	
46001	Safari		⊕ 6.1	Toyota	Prado	90 SWB & 95 LWB	96-02	Front	↔	
46002	Safari		⊕ 6.1	Toyota	Prado	90 SWB & 95 LWB	96-02	Rear	↔	
46003	Safari		⊕ 6.2	Nissan	Navara	4X4 & 4X2 (D40)	05 on	Front	↔	
46004	Safari		⊕ 6.2	Mitsubishi	Pajero	V Series (Mk II)	91-99	Front	↔	
46005	Safari		⊕ 6.2	Mitsubishi	Pajero	V Series (Mk II)	91-99	Rear	↔	
51006	Technomatic		† 3.2	Volkswagen	Citi	Incl. Chicco (Excl. Sonic, Life & VeloCiti)	84 on	Rear	↔	9
					Fox	Incl. Shuttle	87-95	Rear	↔	9
					Golf	Mk I (Imported strut)	78-79	Rear	↔	9
					Golf	Mk I (local strut)	79-84	Rear	↔	9
					Golf	Mk I (local strut)	79-84	Rear	↔	9
					Jetta	Mk I (Imported strut)	78-85	Rear	↔	9
					Jetta	Mk I (local strut)	79-85	Rear	↔	9
51016	Technomatic		† 3.2	Volkswagen	Passat	B2	82-87	Rear	↔	9
51021	Technomatic	69067	† 3.2	Honda	Ballade	130, 150, 150i (SC9) (Civic)	84-87	Rear	↔	
51022	Technomatic	69068	† 3.2	Volkswagen	Golf	Mk II (serviceable strut)	84-92	Rear	↔	
					Golf	Mk III (Excl. VR6 & Cabriolet), Mk II All (Excl. Cabriolet)	93-94	Rear	↔	
					Golf	Mk III All (Excl. Cabriolet)	95-99	Rear	↔	
					Golf	Mk III GTi	94-99	Rear	↔	
					Jetta	Mk II	85-92	Rear	↔	
					Jetta	Mk III	95-99	Rear	↔	
					Jetta	Mk III Cli	94-99	Rear	↔	
51026	Technomatic	OBS.	† 3	Renault	R12	Saloon, Estate	71-75	Front	↔	
51158	Technomatic	69074	† 3.2	Nissan	Laurel	C230	78-87	Rear	↔	
					Skyline	1800, 2000 (R30)	82-87	Rear	↔	
51160	Technomatic	OBS.	† 3.2	Mazda	616	Incl. Capella, RX2	70-79	Rear	↔	
51165	Technomatic	69072	† 3.2	Audi	400, 500	C3, C4	83-94	Rear	↔	
51166	Technomatic	OBS.	† 3.2	Nissan	Skyline	R31	87-92	Rear	↔	
51168	Technomatic		† 3.2	Tata	Indica	1.4 Hatch (V2) (Incl. B-Line, Excl. TDi)	04 on	Rear	↔	
51227	Technomatic	OBS.	† 3	Kia	Sportage	2.0, 2.0D (Mk I)	93-04	Front		
51240	Technomatic		⊕ 6.1	Toyota	Prado	90 SWB & 95 LWB	96-02	Front	↔	
51308	Technomatic	OBS.	† 3.2	BMW	5 Series	E12 Series	74-76	Rear	↔	
51309	Technomatic		† 3.2	BMW	5 Series	E12 Series	76-85	Rear	↔	18
51310	Technomatic	OBS.	† 3.2	Peugeot	305	Series 1	79-82	Rear	↔	
51323	Technomatic	OBS.	† 3	Renault	Fuego	3-Door Hatchback	80-85	Front		

PARTS LISTING

Shocks & Struts

55088



Part #	Range	Superceding Part #/Status.	Product Type	Make	Model	Derivative	Year	Position	L/R	Note # (pg 6)	
55088	Safari		⊖	6.1	Ford	Triton 0510, 0610	Truck	85-87	Front	↔	
					Isuzu	SBR 422, FJR	Truck	76-83	Front	↔	
					Mitsubishi	Canter	Truck	80 on	Front	↔	
					Nissan	CM 10 F	Truck	87 on	Front	↔	
					Nissan	CM 8 F	Truck	87-95	Front	↔	
					Isuzu	Frontier	4X4, 4X2	98-02	Rear	↔	
					Leyland	FG 550, FG 420	Truck	68-77	Rear	↔	
					Ssangyong	Musso	602TDi, E230EL, E320EL	95-06	Rear	↔	
55208	Safari		±	4	Mercedes-Benz	114, 115 Series	220, 230, 240D, 280E, 280 (Excl. ⓈI)	68-77	Rear	↔	
					Mercedes-Benz	C Class	(W123) 200, 230E, 240D, 250, 280E, 300D (Excl. ⓈI)	77-86	Rear	↔	
					Mercedes-Benz	S Class	(116 Series) 280SE, 280S, 350SE (Excl. ⓈI)	73-81	Rear	↔	
					Mercedes-Benz	S Class	(W126) 280SE, 300SE, 380SE, 420SE, 500SE, 560SE Incl. SEL & SEC (Excl. ⓈI)	81-93	Rear	↔	
55210	Safari		⊙	8.5	Mercedes-Benz	0.309D	Bus	19..	Front	↔	
					Mercedes-Benz	L408, L508, L608	Truck	79 on	Front	↔	
					Mercedes-Benz	MB 800	Bus	19..	Front	↔	
					Mercedes-Benz	MB 800	Truck	19..	Front	↔	
					Mercedes-Benz	0.309D	Bus	19..	Rear	↔	
					Mercedes-Benz	608 LP, LPK, LPS, LPO	Truck	19..	Rear	↔	
					Mercedes-Benz	609, 811 LP, LPS, LPK	Truck	19..	Rear	↔	
					Mercedes-Benz	808 LP, LPS, LPK	Truck	19..	Rear	↔	
					Mercedes-Benz	L408, L508, L608	Truck	79 on	Rear	↔	
55211	Safari		⊖	6.1	Ford	Triton 0608, 0610	Truck	87 on	Front	↔	
					Isuzu	FRR500	Truck	19..	Front	↔	
					Isuzu	N2800 P	Truck	93 on	Front	↔	29
					Isuzu	N3000 P	Truck	87-90	Front	↔	29
					Isuzu	NKR55/99	Truck	19..	Front	↔	29
					Isuzu	TL40-50	Truck	75 on	Front	↔	29
					Isuzu	TLD 24	Truck	77-88	Front	↔	29
					Isuzu	TLD44, TLD54	Truck	77-89	Front	↔	
					Mazda	T2000, 3000	LDV	83 on	Front	↔	
					Mazda	T2000, T3000	Truck	81-86	Front	↔	
55224	Safari	OBS.	⊙	8.5	Magirus-Deutz	130D, 232D 16S, 16FS	Truck	78-82	Front	↔	
					Samag	130 - 12 FK/FL	Truck	83-87	Front	↔	
					Samag	168 - 16 K/L	Truck	83-87	Front	↔	
55227	Safari		⊖	6.2	Volkswagen	Kombi	Microbus (Excl. Synchro 4X4)	80-02	Front	↔	12
55231	Safari		⊖	6.2	Tata	Telcoline	4X4, 4X2	04 on	Front	↔	
55232	Safari		⊙	8.5	Tata	LPT 509M 4X2 F-C	Truck	19..	Rear	↔	
					Tata	SFC 407 2T 4X2 F-C	Truck	19..	Rear	↔	

55088 - 55232



55233

PARTS LISTING

Shocks & Struts

55233 - 55812

Part #	Range	Superceding Part #/Status.	Product Type	Make	Model	Derivative	Year	Position	L/R	Note # (pg 6)
55233	Safari		☉ 8.5	Tata	LPT 709 3T 4X2 F-C	Truck	19..	Front	↔	
				Tata	LPT 713 S 4X2 F-C	Truck	19..	Front	↔	
				Tata	LPT 713 S Chassis 4X2 Bus	Truck	19..	Front	↔	
55234	Safari		☉ 8.5	Tata	LPT 709 3T 4X2 F-C	Truck	19..	Rear	↔	
				Tata	LPT 713 S 4X2 F-C	Truck	19..	Rear	↔	
				Tata	LPT 713 S Chassis 4X2 Bus	Truck	19..	Rear	↔	
55236	Safari		☉ 6.2	Nissan	UD 35	4X2 F-C	96-10	Front	↔	
				Nissan	UD 35A	4X2 F-C	96-10	Front	↔	
				Nissan	UD 40L	Truck	96 on	Front	↔	
55237	Safari		☉ 8.2	Nissan	UD 40L	Truck	96 on	Rear	↔	
55238	Safari		☉ 6.1	Toyota	Dyna	7-145	08 on	Front	↔	
55239	Safari		☉ 8.2	Toyota	Dyna	7-105	03-on	Rear	↔	
				Toyota	Dyna	7-145	08 on	Rear	↔	
				Toyota	Dyna	8-145	03-on	Rear	↔	
55240	Safari		☉ 8.2	Isuzu	N Series	NQR500T & NPR400	98-06	Rear	↔	
55241	Safari		☉ 8.2	Toyota	Dyna	5-103 4X2	19..	Rear	↔	
55242	Safari		☉ 8.2	Isuzu	N Series	N4000D & N3500D	88-99	Rear	↔	
55243	Safari		☉ 8.5	Isuzu	N Series	NPR 300, 400	84-03	Front	↔	
55800	Gas Ryder	35842	☉ 1.1	Ford	Sierra, Sapphire	2300, 2000, 1600	83-93	Front	↔	
				Ford	Sierra, Sapphire	3000 (Incl. XR6)	83-93	Front	↔	
				Ford	Sierra, Sapphire	Estate	83-93	Front	↔	
55801	Gas Ryder	35816	☉ 1.1	Ford	Escort	Mk III FWD L, GL, GLE	81-86	Front	↔	
				Ford	Escort	Mk III FWD XR3, Sport	81-86	Front	↔	
55802	Gas Ryder		☉ 1.2	Ford	Escort	Mk III FWD L, GL, GLE	81-86	Rear	↔	
				Ford	Escort	Mk III FWD XR3, Sport	81-86	Rear	↔	
55803	Gas Ryder		☉ 1.1	Mazda	323	Incl. S, EGi, Sport	82-91	Front	↔	
55804	Gas Ryder		☉ 1.1	Ford	Laser, Meteor, Tracer	KC/KE, GC	86-91	Rear	↔	
				Ford	Laser, Meteor, Tracer	KF/KH	91-01	Rear	↔	
				Mazda	323	(Familia) Incl. Midge & Sting	91-04	Rear	↔	
				Mazda	323	Incl. S, EGi, Sport	82-91	Rear	↔	
55806	Gas Ryder		☉ 1.1	Mazda	626	Incl. Coupe (Mk II, Mk III)	83-92	Front	↔	
55807	Gas Ryder		☉ 1.1	Mazda	626	Incl. Coupe (Mk II, Mk III)	83-92	Rear	↔	
55810	Gas Ryder		☉ 1.1	Honda	Ballade	130, 150, 150i (SC9) (Civic)	84-87	Front	↔	
55811	Gas Ryder		☉ 1.1	Volkswagen	Golf	Mk II (serviceable strut)	84-92	Front	↔	
				Volkswagen	Golf	Mk III (Excl. VR6 & Cabriolet), Mk II All (Excl. Cabriolet)	93-94	Front	↔	
				Volkswagen	Jetta	Mk II	85-92	Front	↔	
				Volkswagen	Jetta	Mk III (Excl. VR6), Mk II	93-94	Front	↔	
55812	Gas Ryder		☉ 1.1	Toyota	Conquest	FWD (E80)	85-89	Front	↔	
				Toyota	Corolla	FWD (Incl. Avante) (E80)	85-89	Front	↔	



Part #	Range	Superceding Part #/Status.	Product Type	Make	Model	Derivative	Year	Position	L/R	Note # (pg 6)	
55813	Gas Ryder		f	1.1	Toyota	Conquest	FWD (E80)	85-89	Rear	↔	
					Toyota	Corolla	FWD (Incl. Avante) (E80)	85-89	Rear	↔	
55815	Gas Ryder		f	1.1	Mercedes-Benz	C Class	(W201) 190E (Excl.)	83-94	Front	↔	
					Mercedes-Benz	C Class	(W124) 200, 230E, 260E, 300D, 300E (Excl.)	86-95	Front	↔	
55816	Gas Ryder		f	1.1	Nissan	Sentra	Sedan, Coupe (B12)	87-92	Front	↔	
55817	Gas Ryder		f	1.1	Nissan	Sentra	Sedan, Coupe (B12)	87-92	Rear	↔	
55818	Gas Ryder		f	1.1	Toyota	Conquest	FWD (E90)	85-88	Front	↔	
					Toyota	Corolla	FWD (E90)	89-96	Front	↔	
					Toyota	Corolla Carri	E90	98-05	Front	↔	
					Toyota	Tazz	FWD (E90)	96-07	Front	↔	
55819	Gas Ryder		f	1.1	Toyota	Conquest	FWD (E90)	85-88	Rear	↔	
					Toyota	Corolla	FWD (E90)	89-96	Rear	↔	
					Toyota	Corolla Carri	E90	98-05	Rear	↔	
					Toyota	Tazz	FWD (E90)	96-07	Rear	↔	
55820	Gas Ryder	OBS.	f	1.1	Honda	Ballade	160i (SH4) (Civic)	87-89	Front	↔	
55825	Gas Ryder		f	1.1	Ford	Laser, Meteor, Tracer	KF/KH	91-01	Front	↔	
					Mazda	323	(Familia) Incl. Midge & Sting	91-04	Front	↔	
55833	Gas Ryder		f	1.1	Volkswagen	Citi	Incl. Chicco (Excl. Sonic, Life & VeloCiti)	84 on	Front	↔	
					Volkswagen	Citi	Sonic, Life & VeloCiti	98 on	Front	↔	
					Volkswagen	Fox	Incl. Shuttle	87-95	Front	↔	
					Volkswagen	Golf	Mk I (local strut)	79-84	Front	↔	
					Volkswagen	Golf	Pick-up (sealed strut)	93-03	Front	↔	
					Volkswagen	Jetta	Mk I (local strut)	79-85	Front	↔	
55834	Gas Ryder		f	1.1	BMW	3 Series	E36 Series (Excl. M3)	91-99	Front	L	
					BMW	3 Series	E36 Series Cabriolet	93-99	Front	L	
55835	Gas Ryder		f	1.1	BMW	3 Series	E36 Series (Excl. M3)	91-99	Front	R	
					BMW	3 Series	E36 Series Cabriolet	93-99	Front	R	
55838	Gas Ryder		f	1.1	Nissan	Sabre	160, 200 (Excl. ABS)	92-01	Front	L	
					Nissan	Sentra	140	92-01	Front	L	
					Nissan	Sentra	160, 200 (Excl. STi)	92-01	Front	L	
55839	Gas Ryder		f	1.1	Nissan	Sabre	160, 200 (Excl. ABS)	92-01	Front	R	
					Nissan	Sentra	140	92-01	Front	R	
					Nissan	Sentra	160, 200 (Excl. STi)	92-01	Front	R	
55840	Gas Ryder		f	1.1	Nissan	Sentra	140	92-01	Rear	↔	
55841	Gas Ryder		f	1.1	Volkswagen	Golf	Mk III All (Excl. Cabriolet)	95-99	Front	↔	
					Volkswagen	Golf	Mk III GTi	94-99	Front	↔	
					Volkswagen	Golf	Mk III VR6	93-99	Front	↔	
					Volkswagen	Jetta	Mk III	95-99	Front	↔	
					Volkswagen	Jetta	Mk III Cli	94-99	Front	↔	
					Volkswagen	Jetta	Mk III VR6	93-99	Front	↔	
					Volkswagen	Polo	Classic (Mk III)	96-02	Front	↔	
					Volkswagen	Polo	Playa (9N)	98-02	Front	↔	

55813 - 55841



55843

PARTS LISTING

Shocks & Struts

55843 – 55872







Part #	Range	Superceding Part #/Status.	Product Type	Make	Model	Derivative	Year	Position	L/R	Note # (pg 6)
55843	Gas Ryder		1.1	Ford	Telstar	Incl. TX5	93-99	Front	L	
				Mazda	626	2.0, 2.5 (Incl. MX-6) (Mk IV)	92-98	Front	L	
55844	Gas Ryder		1.1	Ford	Telstar	Incl. TX5	93-99	Front	R	
				Mazda	626	2.0, 2.5 (Incl. MX-6) (Mk IV)	92-98	Front	R	
55845	Gas Ryder		1.1	Ford	Telstar	Incl. TX5	93-99	Rear	←→	
				Mazda	626	2.0, 2.5 (Incl. MX-6) (Mk IV)	92-98	Rear	←→	
55846	Gas Ryder		1.1	Toyota	Camry	XV10	93-97	Front	L	
55847	Gas Ryder		1.1	Toyota	Camry	XV10	93-97	Front	R	
55848	Gas Ryder		1.1	Toyota	Camry	XV10	93-97	Rear	L	
				Toyota	Camry	SV20	96-01	Rear	L	
				Toyota	Camry	XV20	97-01	Rear	L	
55849	Gas Ryder		1.1	Toyota	Camry	XV10	93-97	Rear	R	
				Toyota	Camry	SV20	96-01	Rear	R	
				Toyota	Camry	XV20	97-01	Rear	R	
55854	Gas Ryder		1.1	Fiat	Uno	Incl. Turbo (Series 2)	90-06	Front	←→	
				Fiat	Uno	Panel van (Series 2)	90-06	Front	←→	
55855	Gas Ryder		1.1	Nissan	Sabre	160, 200 (Excl. ABS)	92-01	Rear	L	
				Nissan	Sentra	160, 200 (Excl. STi)	92-01	Rear	L	
55856	Gas Ryder		1.1	Nissan	Sabre	160, 200 (Excl. ABS)	92-01	Rear	R	
				Nissan	Sentra	160, 200 (Excl. STi)	92-01	Rear	R	
55858	Gas Ryder		1.1	Opel	Corsa	(B) Utility	96-04	Front	←→	
				Opel	Corsa	B	96-02	Front	←→	
				Opel	Corsa	Corsa Lite (B)	02-07	Front	←→	
55861	Gas Ryder		1.1	Toyota	Corolla	Excl. RSi (E100)	96-02	Front	←→	
				Toyota	Corolla	RSi (E100)	96-02	Front	←→	
55863	Gas Ryder		1.1	Toyota	Corolla	Excl. RSi (E100)	96-02	Rear	←→	
55865	Gas Ryder		1.1	Ford	Fiesta	Mark IV (Excl. 1.6 RSi 3-Door) (Sleeve eye)	99-03	Front	←→	
				Ford	Fiesta	Mark IV (Excl. 1.6 RSi 3-Door) (U Bracket)	97-99	Front	←→	
				Ford	Ikon	B3 (Sleeve eye)	00-06	Front	←→	
				Ford	Ikon	B3 (U Bracket)	00-06	Front	←→	
				Mazda	Soho	121 (Bracket)	97-99	Front	←→	23
				Mazda	Soho	121 (Eye)	97-99	Front	←→	22
55868	Gas Ryder		1.1	Hyundai	Accent	X3	94-97	Rear	←→	
55869	Gas Ryder		1.1	Hyundai	Accent	X3	94-97	Front	←→	
				Hyundai	Accent	X3	98-00	Front	←→	
55870	Gas Ryder		1.1	Hyundai	Accent	X3	98-00	Rear	←→	
55872	Gas Ryder		1.1	Audi	A3	Excl. S3 (8L1)	98-03	Front	←→	
				Volkswagen	Beetle	Mk II	99 on	Front	←→	
				Volkswagen	Golf	Mk IV 1.8, GTi, 1.9 TDi, 2.0, 2.3V5	99-04	Front	←→	
				Volkswagen	Golf	Mk IV 1.8, GTi, 1.9 TDi, 2.0, 2.3V5 (with 22mm strut rod)	99-04	Front	←→	

PARTS LISTING

Shocks & Struts

55872



Part #	Range	Superceding Part #/Status.	Product Type	Make	Model	Derivative	Year	Position	L/R	Note # (pg 6)
55872	Gas Ryder		f 1.1	Volkswagen	Jetta	Mk IV (with 22mm strut rod)	99-06	Front	↔	
55881	Gas Ryder		f 1.1	Volkswagen	Golf	Mk IV 1.6	99-04	Front	↔	
				Volkswagen	Golf	Mk IV 1.6 (with 20mm strut rod)	99-04	Front	↔	
				Volkswagen	Jetta	Mk IV 1.6 (with 20mm strut rod)	99-06	Front	↔	
55886	Gas Ryder		f 1.1	Toyota	Camry	XV20	97-01	Front	L	
55887	Gas Ryder		f 1.1	Toyota	Camry	XV20	97-01	Front	R	
55888	Gas Ryder		f 1.1	Mazda	Etude	1.6 litre (BJ)	10.02-04	Front	L	
55889	Gas Ryder		f 1.1	Mazda	Etude	1.6 litre (BJ)	10.02-04	Front	R	
55890	Gas Ryder		f 1.1	Mazda	Etude	1.6 litre (BJ)	00-09.02	Rear	L	
				Mazda	Etude	1.6 litre (BJ)	10.02-04	Rear	L	
55891	Gas Ryder		f 1.1	Mazda	Etude	1.6 litre (BJ)	00-09.02	Rear	R	
				Mazda	Etude	1.6 litre (BJ)	10.02-04	Rear	R	
55892	Gas Ryder		f 1.1	Toyota	Corolla	E120, E130	02-07	Front	L	
				Toyota	RunX	E120, E130	02-07	Front	L	
55893	Gas Ryder		f 1.1	Toyota	Corolla	E120, E130	02-07	Front	R	
				Toyota	RunX	E120, E130	02-07	Front	R	
55898	Gas Ryder	OBS.	f 1.1	Chrysler	Neon	11	00-06	Front	↔	
55899	Gas Ryder	OBS.	f 1.1	Chrysler	Neon	11	00-06	Rear	L	
55900	Gas Ryder	OBS.	f 1.1	Chrysler	Neon	11	00-06	Rear	R	
55911	Gas Ryder	OBS.	f 1.1	Chrysler	PT Cruiser	Incl. Convertible	00-10	Front	↔	
61200	Gas Ryder	G45839	o 6.2	Chevrolet / Opel	Ascona, Chevaïr	Incl. Coupe (C)	82-85	Rear	↔	
				Chevrolet / Opel	Ascona, Chevaïr	Incl. Coupe (short strut) (C)	84-86	Rear	↔	
				Opel	Kadett	D	80-85	Rear	↔	
				Opel	Kadett	T-car (E)	85-89	Rear	↔	
				Opel	Monza	Incl. GSi	86-89	Rear	↔	
61201	Gas Ryder		s 7.1	Mercedes-Benz	114, 115 Series	220, 230, 240D, 280E, 280 (Excl. )	68-77	Front	↔	
				Mercedes-Benz	SL Class	280 SL, SLC, 350 SL, SLC (Excl. )	71-81	Front	↔	
				Mercedes-Benz	SL Class	450 SL, SLC (Excl. )	73-81	Front	↔	
61202	Gas Ryder		s 7.1	Mercedes-Benz	E Class	(W123) 200, 230E, 240D, 250, 280E, 300D (Excl. )	77-87	Front	↔	
				Mercedes-Benz	S Class	(116 Series) 280SE, 280S, 350SE (Excl. )	73-81	Front	↔	
				Mercedes-Benz	S Class	(W126) 280SE, 300SE, 380SE, 420SE, 500SE, 560SE Incl. SEL & SEC (Excl. )	81-93	Front	↔	
61212	Gas Ryder		o 6.1	Toyota	Cressida	With IRS+, MX73 (Mk III)	83-93	Rear	↔	
61213	Gas Ryder	G45503	e 10	Ford	Cortina	Mk III	71-77	Front	↔	
				Ford	Cortina	Mk III, IV	71-78	Front	↔	
				Ford	Cortina	Mk IV	77-80	Front	↔	
				Ford	Cortina	Mk IV	78-80	Front	↔	

55872 - 61213



61214

PARTS LISTING

Shocks & Struts

61214 – 61248

Part #	Range	Superceding Part #/Status.	Product Type	Make	Model	Derivative	Year	Position	L/R	Note # (pg 6)
61214	Gas Ryder	G45520	8.5	Ford	Cortina	Mk III	71-77	Rear	↔	
				Ford	Cortina	Mk IV	77-80	Rear	↔	
				Ford	Cortina	Mk V	80-83	Rear	↔	
61228	Gas Ryder		6.1	Toyota	Celica, Supra	A60 Series (Mk III)	81-85	Rear	↔	
				Toyota	Cressida	Non IRS+, MX63 (Mk II)	81-93	Rear	↔	
				Toyota	Cressida	X30, X32 (Imported strut) (Mk I)	77-79	Rear	↔	
				Toyota	Cressida	X30, X32 (local strut) (Mk I)	79-81	Rear	↔	
61230	Gas Ryder		6.1	Opel	Rekord	380i V6	91-97	Rear	↔	
				Opel	Senator	A	79-86	Rear	↔	
61232	Gas Ryder	G45837	10	Ford	Cortina	Mk V	80-83	Front	↔	
				Ford	Cortina	Mk V	80-82	Front	↔	
				Ford	Cortina	Mk V	80-83	Front	↔	
				Ford	Cortina	Mk V	83-86	Front	↔	
61233	Gas Ryder	G45838	6.2	Ford	Cortina	Mk V	80-83	Rear	↔	
61234	Gas Ryder	G45212	4	Opel	2500, 3800, 4100	2.5, 3.8, & 4.1 Estate	75-78	Front	↔	
				Opel	2500, 3800, 4100	2.5, 3.8, & 4.1 Sedan	73-78	Front	↔	
				Opel	Rekord	C	67-73	Front	↔	
61235	Gas Ryder	G45841	6.1	Toyota	Corolla	RWD (Excl. Van, Station Wagon) (E70)	80-85	Rear	↔	
61235	Gas Ryder	G45841	6.1	Toyota	Corona	Mk I	74-80	Rear	↔	
61238	Gas Ryder	G45860	8.5	Ford	Sierra, Sapphire	2300, 2000, 1600	83-93	Rear	↔	
				Ford	Sierra, Sapphire	3000 (Incl. XR6)	83-93	Rear	↔	
61239	Gas Ryder	36857	6.2	BMW	3 Series	E30 Series (Excl. iS & Cabriolet)	83-91	Rear	↔	
61241	Gas Ryder		6.2	Fiat	Uno	Incl. Turbo (Series 2)	90-06	Rear	↔	
				Fiat	Uno	Panel van (Series 2)	90-06	Rear	↔	
61242	Gas Ryder	G45874	6.2	Daewoo	Cielo	Nexia	95-98	Rear	↔	
				Daewoo	Espero	Aranos	95-98	Rear	↔	
				Daewoo	Lanos	Sens	97-03	Rear	↔	
				Opel	Astra	F	93-99	Rear	↔	
				Opel	Kadett	Astra	93-99	Rear	↔	
				Opel	Kadett	T-car (E)	89-93	Rear	↔	
				Opel	Monza	Incl. Cub	89-93	Rear	↔	
61243	Gas Ryder	G45858	4	Ford	Sierra, Sapphire	Estate	83-93	Rear	↔	
61248	Gas Ryder		6.2	BMW	3 Series	E36 Series (Excl. M3)	91-99	Rear	↔	
				BMW	3 Series	E36 Series (Imported 4 cyl. models)	91-99	Rear	↔	
				BMW	3 Series	E36 Series (Imported 6 cyl. models)	91-99	Rear	↔	
				BMW	3 Series	E36 Series (Imported Excl. M-Series) 320i, 325i, 325td (long Stud)	91-92	Rear	↔	
				BMW	3 Series	E36 Series Cabriolet	93-99	Rear	↔	
				BMW	3 Series	E46 Series (Excl. M3, + Touring) one pin at the bottom strut mounting	99-05	Rear	↔	

PARTS LISTING

Shocks & Struts

61252



Part #	Range	Superceding Part #/Status.	Product Type	Make	Model	Derivative	Year	Position	L/R	Note # (pg 6)	
61252	Gas Ryder		♀	9.2	Opel	Astra	Estate (F)	94-01	Rear	↔	7
					Opel	Kadett	Estate (D)	80-85	Rear	↔	7
61253	Gas Ryder		♂	6.2	Mercedes-Benz	C Class	(W202) C180, C200, C220, C230, C250, C280	94-00	Front	↔	
61254	Gas Ryder		♂	6.2	Mercedes-Benz	C Class	(W202) C180, C200, C220, C230, C250, C280	94-00	Rear	↔	
61256	Gas Ryder		♂	6.2	Opel	Corsa	B	96-02	Rear	↔	
					Opel	Corsa	Corsa Lite (B)	02-07	Rear	↔	
					Opel	Corsa	Excl. Corsa Lite (C)	02-07	Rear	↔	
61257	Gas Ryder		♀	8.5	Opel	Corsa	(B) Utility	96-04	Rear	↔	
61262	Gas Ryder		♂	6.2	Audi	A3	Excl. S3 (8L1)	98-03	Rear	↔	
					Volkswagen	Beetle	Mk II	99 on	Rear	↔	
					Volkswagen	Golf	Mk IV 1.6 (with 20mm strut rod)	99-04	Rear	↔	
					Volkswagen	Golf	Mk IV 1.8, GTi, 1.9 TDi, 2.0, 2.3V5 (with 22mm strut rod)	99-04	Rear	↔	
					Volkswagen	Jetta	Mk IV (with 22mm strut rod)	99-06	Rear	↔	
					Volkswagen	Jetta	Mk IV 1.6 (with 20mm strut rod)	99-06	Rear	↔	
61270	Gas Ryder		♂	6.2	Fiat	Palio	Type 1X	00-02	Rear	↔	
					Fiat	Siena	Type 2A	00-02	Rear	↔	
61281	Technomatic		♀	8.2	Mahindra	Bolero	4X4	05 on	Rear	↔	
61282	Technomatic		♂	6.2	Mahindra	Bolero	4X4	05 on	Front	↔	
61283	Technomatic		♂	4	Mahindra	Scorpio	4X2	05 on	Front	↔	
61284	Gas Ryder	OBS.	♀	8.5	Hyundai	Trajet	2.0, 2.7	01-08	Rear	↔	
61285	Gas Ryder		♂	6.2	Hyundai	Getz	3 & 5-Door	03 on	Rear	↔	
61286	Gas Ryder		♂	6.2	Peugeot	307	1.6, 2.0 Excl. CC	01-08	Rear	↔	
61287	Gas Ryder		♂	6.2	Hyundai	Terracan	2.9, 3.5	01-09	Front	↔	
61288	Gas Ryder		♂	6.2	Hyundai	Terracan	2.9, 3.5	01-09	Rear	↔	
61289	Gas Ryder		♂	6.2	Hyundai	Santa Fe	SM	01-06	Rear	↔	
61292	Gas Ryder		♂	6.2	BMW	X5	E53 3.0i, 3.0d, 4.4iV8, 4.8 V8 4X4	01-07	Rear	↔	
61293	Gas Ryder		♂	6.2	Volkswagen	Golf	Mk V 1.6l	04-09	Rear	↔	
					Volkswagen	Golf	Mk V 1.9T Di, 2.0 FSi	04-09	Rear	↔	
					Volkswagen	Golf	Mk VI (Excl. GTi, V5, R32, AWD & Sport Susp.)	09 on	Rear	↔	
61294	Gas Ryder		♀	8.5	Mercedes-Benz	Vito	112 Cdi Bus	03-04	Rear	↔	
					Mercedes-Benz	Vito	112 CDi 2.2 Cr-Cab Panel Van Diesel	03	Rear	↔	
					Mercedes-Benz	Vito	112 CDi 2.2 Panel Van Diesel	02-04	Rear	↔	
61295	Gas Ryder		♀	13.2	Kia	Rio	1.3 & 1.6 (DC)	00-03	Rear	↔	
61296	Gas Ryder	NEW	♂	6.2	Honda	Jazz	1.4Dsi, 1.5 Gen 1	03-07	Rear	↔	
61297	Gas Ryder		♂	6.2	Toyota	Corolla	1.3, 1.4, 1.6 & 1.8 (E140, E150)	07 on	Rear	↔	
					Toyota	Corolla	2.0 D4D (E140, E150)	07 on	Rear	↔	
61298	Gas Ryder		♂	6.2	Audi	A4	Excl. Sport Susp. (B6)	01-05	Rear	↔	

61252 - 61298



Part #	Range	Superceding Part #/Status.	Product Type	Make	Model	Derivative	Year	Position	L/R	Note # (pg 6)	
61299	Gas Ryder		6.2		Ford	Fiesta	Mark V Hatch & Sedan	02-08	Rear	↔	
					Ford	Figo	1.4	10 on	Rear	↔	
					Ford	Ikon	Sedan All	07 on	Rear	↔	
					Mazda	Demio	Hatch DY	02-07	Rear	↔	
					Mazda	Mazda 2	Hatch DY (Demio)	02-07	Rear	↔	
61302	Gas Ryder		2	/	BMW	5 Series	E34 Series (Excl. M5)	89-96	Front	↔	
					BMW	7 Series	E32 Series	87-94	Front	↔	
61303	Gas Ryder		2	/	Audi	100, 200	C2	77-84	Front	↔	
					Audi	400, 500	C3, C4	83-94	Front	↔	
					Audi	A6	Incl. Avant. Excl. Quattro (C4)	94-97	Front	↔	
					Volkswagen	Golf	Incl. Sport (serviceable strut) (Typ 14)	81-93	Front	↔	
61404	Gas Ryder	44085	2	/	BMW	3 Series	E30 Series (Excl. iS & Cabriolet)	83-91	Front	↔	
61702	Gas Ryder	OBS.	5	†	Rover	Rover	2600, 3500 (V8)	78-84	Rear	↔	11
61900	Gas Ryder	44611	2	/	Opel	Commodore	C	78-88	Front	↔	
					Opel	Commodore	C	78-92	Front	↔	
					Opel	Rekord	380i V6	91-97	Front	↔	
					Opel	Rekord	Caravan (E)	78-92	Front	↔	
					Opel	Rekord	Sedan (Excl. V6) (E)	78-97	Front	↔	
					Opel	Senator	A	79-86	Front	↔	
61901	Gas Ryder	44614	2	/	Toyota	Corolla	Imported strut (E30, E40, E50, E60)	82-85	Front	↔	
					Toyota	Corolla	RWD (Excl. Van, Station Wagon) (E70)	80-85	Front	↔	
61902	Gas Ryder	44601	2	/	BMW	5 Series	E12 Series	74-76	Front	↔	
					BMW	5 Series	E12 Series	76-85	Front	↔	
61903	Gas Ryder		2	/	Toyota	Cressida	MX63 (Mk II)	81-93	Front	↔	
					Toyota	Cressida	Non IRS+, MX63 (Mk II)	81-93	Front	↔	
					Toyota	Cressida	With IRS+, MX73 (Mk III)	83-93	Front	↔	
61904	Gas Ryder	44608	2	/	Nissan	Laurel	C230	78-87	Front	↔	
					Nissan	Skyline	1800, 2000 (R30)	82-87	Front	↔	
					Nissan	Skyline	2800 GLX, GTX (R30)	82-87	Front	↔	
61906	Gas Ryder	OBS.	2	/	BMW	7 Series	E23 Series (Excl. I)	77-86	Front	↔	
61909	Gas Ryder		2	/	Daewoo	Cielo	Nexia	95-98	Front	↔	
					Daewoo	Espero	Aranos	95-98	Front	↔	
					Daewoo	Lanos	Sens	97-03	Front	↔	
					Opel	Kadett	D	80-85	Front	↔	
					Opel	Kadett	Estate (D)	80-85	Front	↔	
					Opel	Kadett	T-car (E)	85-89	Front	↔	
					Opel	Kadett	T-car (E)	89-93	Front	↔	
					Opel	Monza	Incl. Cub	89-93	Front	↔	
					Opel	Monza	Incl. GSi	86-89	Front	↔	
61912	Gas Ryder	OBS.	2	/	Rover	Rover	2600, 3500 (V8)	78-84	Front	↔	

PARTS LISTING

Shocks & Struts

61914



61914 – 62025

Part #	Range	Superceding Part #/Status.	Product Type	Make	Model	Derivative	Year	Position	L/R	Note # (pg 6)
61914	Gas Ryder		/ 2	BMW	5 Series	E28 Series (Excl. M5)	85-89	Front	↔	
61915	Gas Ryder		/ 2	Nissan	Skyline	R31	87-92	Front	↔	
61918	Gas Ryder		/ 2	Opel	Astra	Estate (F)	94-01	Front	↔	
				Opel	Astra	F	93-99	Front	↔	
				Opel	Kadett	Astra	93-99	Front	↔	
62000	Gas Ryder		⊘ 6.2	Kia	Picanto	Mk I Incl. 2007 & 2010 facelift (SA)	04-11	Rear	↔	
62001	Gas Ryder		⊘ 6.2	Nissan	Micra	5-Door (K12)	04 on	Rear	↔	
62002	Gas Ryder		⊘ 6.2	Volkswagen	Golf	Mk V 2.0 GTi	04-09	Rear	↔	
62003	Gas Ryder		⊘ 6.2	Audi	A4	Sport Susp. Incl. Avant & Quattro(Excl. AllRoad, S4 & RS4) B7 model	05-08	Rear	↔	
62004	Gas Ryder		⊘ 6.2	Mercedes-Benz	C Class	(W203) C180, C200, C220 CDI, C230, C270 CDI, C280, C320 CDI, C350	00-07	Rear	↔	
62005	Gas Ryder		⊘ 6.2	Fiat	Palio	Expresso Panel van	01 on	Rear	↔	
				Fiat	Palio	Type 2H	01 on	Rear	↔	
62006	Gas Ryder		⊘ 6.2	Nissan	Tiida	1.6i & 1.8i Hatch & Sedan	06 on	Rear	↔	
62007	Gas Ryder		/ 1.1	Volkswagen	Kombi	T5 Kombi, Caravelle (Excl. 4-Motion)	04 on	Rear	↔	
				Volkswagen	Kombi	T5 Transporter: Crew bus, Pick-up & Panel van (Excl. 4-Motion)	05 on	Rear	↔	
62008	Gas Ryder		⊘ 8.2	Mercedes-Benz	Sprinter	Panel van	06 on	Rear	↔	
				Volkswagen	Crafter	3 Ton, 3.5 Ton (Excl. 4X4 & 5 Ton) (LT3)	06 on	Rear	↔	
62009	Gas Ryder		⊘ 6.2	Ford	Fiesta	Mk VI	08 on	Rear	↔	
				Mazda	Mazda 2	DE (Demio)	07 on	Rear	↔	
62010	Gas Ryder		⊘ 8.5	Volkswagen	Caddy	50mm OD & 55mm OD struts	04 on	Rear	↔	
62011	Gas Ryder		⊘ 6.2	Honda	Civic	Mk VIII	06 on	Rear	↔	
62012	Gas Ryder		⊘ 6.2	Nissan	NP200	1.5, 1.6	08 on	Rear	↔	
62014	Gas Ryder		⊘ 8.5	Toyota	Rav4	XA30	06 on	Rear	↔	
62015	Gas Ryder		⊘ 13.2	Kia	Rio	1.3 & 1.6 (DC)	03-06	Rear	↔	
62016	Gas Ryder		⊘ 6.2	Hyundai	Accent	MC. 1.6	05-11	Rear	↔	
62018	Gas Ryder	NEW	⊘ 6.2	Volkswagen	Jetta	Mk V	06 on	Rear	↔	
				Volkswagen	Jetta	6 Sedan	11 on	Rear	↔	
62019	Gas Ryder		⊘ 8.5	Opel	Astra	(H) 1.8 & 1.9 CDTi Incl. GTC (Excl. 2.0 Turbo Sport & OPC)	04-09	Rear	↔	
				Opel	Astra	(H) 1.8 & 1.9 CDTi Incl. GTC (Excl. 2.0 Turbo Sport & OPC)	04-09	Rear	↔	
62020	Gas Ryder		⊘ 6.1	Toyota	Rav4	XA20 (Mk II)	01-06	Rear	↔	
62021	Gas Ryder		⊘ 6.2	BMW	X3	E83 2.5, 3.0 & 2.0D	04-10	Rear	↔	
62022	Gas Ryder		⊘ 6.2	Toyota	Auris	1.4, 1.6, 1.8 & 2.0 (330N)	07 on	Rear	↔	
62023	Gas Ryder		⊘ 6.2	Volvo	C30	Hatch	04-11	Rear	↔	
				Volvo	S40	Mk II Incl. T5	04-11	Rear	↔	
62024	Gas Ryder		⊘ 6.2	Audi	A4	Excl. Sport Susp. (B7)	05-08	Rear	↔	
62025	Gas Ryder		⊘ 8.5	Renault	Logan	U 90	08 on	Rear	↔	
				Renault	Sandero	5-Door Hatchback	09-14	Rear	↔	



Part #	Range	Superceding Part #/Status.	Product Type	Make	Model	Derivative	Year	Position	L/R	Note # (pg 6)
62026	Gas Ryder		⊕ 8.5	Nissan	Qashqai	1.6, 2.0, 1.5DCI (J10, J11)	07-14	Rear	↔	
62032	Gas Ryder	NEW	⊕ 6.2	Mercedes-Benz	C Class	C180, C200, C220CDi, C230, C270CDi, C280, C320CDi, C350 (W203)	07 on	Rear	↔	
62033	Gas Ryder		⊕ 8.5	Nissan	X-Trail	4X4 & 4X2 (Mk II)	08 on	Rear	↔	
62035	Gas Ryder		⊕ 6.2	Renault	Scenic	Scenic I (Excl. 4X4)	98-04	Rear	↔	
62036	Gas Ryder	NEW	⊕ 7.1	Hyundai	iX35	SUV 4X2	10 on	Rear	↔	
				Kia	Sportage	SUV 4X2	10 on	Rear	↔	
62037	Gas Ryder		⊕ 8.5	Suzuki	Alto	Gen 7	09 on	Rear	↔	
62038	Gas Ryder		⊕ 8.5	Daihatsu	Terios II	4X2, 4X4	6/06 - on	Rear	↔	
62039	Gas Ryder		⊕ 8.5	Hyundai	i20	Hatch	09 on	Rear	↔	
62040	Gas Ryder	NEW	⊕ 8.5	Daihatsu	Sirion	(Mk II) (Boon) Hatch	05-10	Rear	↔	
62041	Gas Ryder		⊕ 8.5	Renault	Megane	I (excl. Coupe)	96-03	Rear	↔	
62043	Gas Ryder	NEW	⊕ 6.2	Renault	Clio	Clio Mk III Hatch	06-13	Rear	↔	
62044	Gas Ryder	NEW	⊕ 6.2	Opel	Corsa	(D) Hatch	07 on	Rear	↔	
62046	Gas Ryder	NEW	⊕ 8.5	Peugeot	207	Hatch	06 on	Rear	↔	
62052	Gas Ryder	NEW	⊕ 6.2	Chevrolet	Cruze	Sedan	09 on	Rear	↔	
62053	Gas Ryder	NEW	⊕ 8.5	Hyundai	i10	Hatch	08 on	Rear	↔	
62055	Gas Ryder	NEW	⊕ 6.2	Suzuki	Swift	Hatch	08 on	Rear	↔	
62057	Gas Ryder	NEW	⊕ 6.2	Audi	A4	Sedan	08 on	Rear	↔	
62058	Gas Ryder	NEW	⊕ 3.2	Honda	Jazz	Hatch	08 on	Rear	↔	
62060	Gas Ryder	NEW	⊕ 6.2	Toyota	Yaris/Vitz	Yaris/Vitz	99-05	Rear	↔	
62061	Gas Ryder	NEW	⊕ 6.2	Toyota	Ipsium	(ACM 2)	01 on	Rear	↔	
62073	Gas Ryder	NEW	⊕ 6.2	Ford	Focus	Mk III Hatch & Sedan (excl 2.5 ST & RS)	11 on	Rear	↔	
62082	Gas Ryder	NEW	⊕ 6.2	Volvo	S60	Sedan	00-10	Rear	↔	
62083	Gas Ryder	NEW	⊕ 6.2	Mercedes-Benz	E Class	(W212) Sedan	09 on	Rear	↔	
62084	Gas Ryder	NEW	⊕ 8.5	Kia	Picanto	Hatch	11 on	Rear	↔	
62085	Gas Ryder	NEW	⊕ 7.1	Hyundai	Elantra	HD Sedan	06-10	Rear	↔	
62086	Gas Ryder	NEW	⊕ 8.5	Kia	Cerato	Hatch & Sedan	09-13	Rear	↔	
62089	Gas Ryder	NEW	⊕ 8.5	Chevrolet	Spark	M200, M250 Hatch	06-10	Rear	↔	
62090	Gas Ryder	NEW	⊕ 6.2	Toyota	Yaris	Hatch	11 on	Rear	↔	
62091	Gas Ryder	NEW	⊕ 6.2	Nissan	Micra	Hatch	11 on	Rear	↔	
62092	Gas Ryder	NEW	⊕ 6.2	Mercedes-Benz	C Class	(CLC 203) Coupe	00-11	Rear	↔	
62093	Safari	NEW	⊕ 6.2	Hyundai	Accent	Sedan	11-13	Rear	↔	
62094	Gas Ryder	NEW	⊕ 6.2	Nissan	Livina	Incl. X-Gear & Grand Livina (XJ)	06 on	Rear	↔	
62350	Gas Ryder	OBS.	⊕ 3.2	BMW	5 Series	E12 Series	09 on	Rear		
62351	Gas Ryder		⊕ 3.2	BMW	7 Series	E23 Series (Excl. )	77-86	Rear	↔	18
62352	Gas Ryder		⊕ 3.2	BMW	5 Series	E28 Series (Excl. M5)	85-89	Rear	↔	14



Part #	Range	Superceding Part #/Status.	Product Type	Make	Model	Derivative	Year	Position	L/R	Note # (pg 6)
62353	Gas Ryder		‡ 3.2	BMW	5 Series	E34 Series (Excl. M5)	89-96	Rear	↔	14
69050	Gas Ryder		‡ 3.2	Volkswagen	Citi	Incl. Chicco (Excl. Sonic, Life & VeloCiti)	84 on	Rear	↔	9
				Volkswagen	Fox	Incl. Shuttle	87-95	Rear	↔	9
				Volkswagen	Golf	Mk I	78-79	Rear	↔	9
				Volkswagen	Golf	Mk I	79-84	Rear	↔	9
				Volkswagen	Jetta	Mk I	78-85	Rear	↔	9
				Volkswagen	Jetta	Mk I	79-85	Rear	↔	9
69066	Gas Ryder	OBS.	‡ 3.4	Jaguar	Jaguar	XJ6, XJ12 (4 shocks at rear)	70-87	Rear	↔	
69067	Gas Ryder		‡ 3.2	Honda	Ballade	130, 150, 150i (SC9) (Civic)	84-87	Rear	↔	14
				Honda	Ballade	160i (SH4) (Civic)	87-89	Rear	↔	14
69068	Gas Ryder		‡ 3.2	Volkswagen	Golf	Mk II	84-92	Rear	↔	9
				Volkswagen	Golf	Mk III (Excl. VR6 & Cabriolet), Mk II All (Excl. Cabriolet)	93-94	Rear	↔	9
				Volkswagen	Golf	Mk III All (Excl. Cabriolet)	95-99	Rear	↔	9
				Volkswagen	Golf	Mk III GTi	94-99	Rear	↔	9
				Volkswagen	Golf	Mk III VR6	93-99	Rear	↔	9
				Volkswagen	Jetta	Mk II	85-92	Rear	↔	9
				Volkswagen	Jetta	Mk III	95-99	Rear	↔	9
				Volkswagen	Jetta	Mk III Cli	94-99	Rear	↔	9
				Volkswagen	Jetta	Mk III (Excl. VR6), Mk II	93-94	Rear	↔	9
				Volkswagen	Jetta	Mk III VR6	93-99	Rear	↔	9
69069	Gas Ryder	G45469	½ 6.1	Toyota	Cressida	MX63 (Mk II)	81-93	Rear	↔	
69072	Gas Ryder		‡ 3.2	Audi	400, 500	C3, C4	83-94	Rear	↔	14
				Audi	A6	Incl. Avant. Excl. Quattro (C4)	94-97	Rear	↔	14
69073	Gas Ryder		‡ 3.2	Nissan	Skyline	R31	87-92	Rear	↔	13
				Nissan	Skyline	2800 GLX, GTX (R30)	82-87	Rear	↔	13
69074	Gas Ryder		‡ 3.2	Nissan	Laurel	C230	78-87	Rear	↔	13
				Nissan	Skyline	1800, 2000 (R30)	82-87	Rear	↔	13
69075	Gas Ryder		‡ 3.1	Honda	Ballade	150, 160i (SH4) (Civic)	89-92	Front	↔	
69076	Gas Ryder		‡ 3.2	Honda	Ballade	150, 160i (SH4) (Civic)	89-92	Rear	↔	
				Honda	Ballade	150, 160i (SR4) (Civic)	92-96	Rear	↔	
69079	Gas Ryder		‡ 3.1	Honda	Ballade	150, 160i (SR4) (Civic)	92-96	Front	↔	
69081	Gas Ryder		‡ 3.2	Volkswagen	Polo	Classic (Mk III)	96-02	Rear	↔	9
				Volkswagen	Polo	Playa (9N)	98-02	Rear	↔	9
69082	Gas Ryder		‡ 3.3	Ford	Fiesta	Mark IV (Excl. 1.6 RSi 3-Door) (U Bracket)	97-99	Rear	↔	23
				Ford	Ikon	B3 (U Bracket)	00-06	Rear	↔	23
69084	Gas Ryder		‡ 3.1	Honda	Ballade	150i, 160i, 180i Excl. Vtech (Mk VI) (Civic)	96-01	Front	↔	
				Honda	Civic	Mk VI	96-01	Front	↔	

62353 - 69084



Part #	Range	Superceding Part #/Status.	Product Type	Make	Model	Derivative	Year	Position	L/R	Note # (pg 6)
69087	Gas Ryder		‡ 3.3	Audi	A4	1.8, 2.4, 2.6, 2.8 Excl. Quattro (B5)	94-01	Front	↔	
				Audi	A4	Quattro Excl. Sport Susp. (B5)	94-01	Front	↔	
				Volkswagen	Passat	1.6, 1.8, 1.8T, 2.0, 1.9TDI Excl. 4X4 (B5)	99-05	Front	↔	
				Volkswagen	Passat	B5 2.3 V5 & 2.8 4WD 4-Motion Syncro	99-05	Front	↔	
69089	Gas Ryder		‡ 3.2	Volkswagen	Citi	Sonic, Life & VeloCiti	98 on	Rear	↔	9
69092	Gas Ryder		‡ 3.2	Toyota	Bubble	(1NZ)	02-07	Rear	↔	
				Toyota	Corolla	E120, E130	02-07	Rear	↔	
				Toyota	RunX	E120, E130	02-07	Rear	↔	
69093	Gas Ryder		‡ 3.2	Nissan	Almera	Excl. ABS (N16)	01-07	Rear	↔	
69095	Gas Ryder		‡ 3.2	Ford	Fiesta	Mark IV (Excl. 1.6 RSi 3-Door) (Sleeve eye)	99-03	Rear	↔	22
				Ford	Ikon	B3 (Sleeve eye)	00-06	Rear	↔	22
				Mazda	Soho	121 (Eye)	97-99	Rear	↔	22
69099	Gas Ryder		‡ 3.1	Hyundai	Sonata	EF	03.01-02.05	Front	↔	
				Hyundai	Sonata	EF	09.98-03.01	Front	↔	
69100	Gas Ryder		‡ 3.2	Hyundai	Sonata	EF	03.01-02.05	Rear	↔	
69101	Gas Ryder		‡ 3.3	Audi	A4	Excl. Sport Susp. (B6)	01-05	Front	↔	
				Audi	A4	Excl. Sport Susp. (B7)	05-08	Front	↔	
69102	Gas Ryder		‡ 5	BMW	1 Series	E81 3-Door	07-11	Rear	↔	
				BMW	1 Series	E82 Coupe	08 on	Rear	↔	
				BMW	1 Series	E87 5-Door	04-11	Rear	↔	
				BMW	1 Series	E88 Cabriolet	08 on	Rear	↔	
				BMW	3 Series	E90 Series (Excl. M3, Cabrio & Coupe)	05-12	Rear	↔	
				BMW	3 Series	E91 Series	05-12	Rear	↔	
				BMW	3 Series	E92 Series	07 on	Rear	↔	
BMW	3 Series	E93 Series	07 on	Rear	↔					
69103	Gas Ryder		⊕ 6.2	Toyota	Corolla	NZE120/121, ZZE121	02 on	Rear	↔	
69104	Gas Ryder		⊕ 6.2	Honda	CR-V	Mk II 4X4 2.0, 2.2D (RD4, RD5, RD6, RD7)	02 on	Rear	↔	
69106	Gas Ryder		⊕ 6.2	Toyota	Verso	1.6, 1.8, 2.0 (Mk III) (Spacio)	04-09	Rear	↔	
69107	Gas Ryder	NEW	⊗ 8.5	Mazda	Mazda 6	All Excluding MPS (GG/GY)	03 on	Front	L	
69108	Gas Ryder	NEW	⊗ 8.5	Mazda	Mazda 6	All Excluding MPS (GG/GY)	03 on	Front	R	
69109	Gas Ryder	NEW	‡ 3.2	Mini	Cooper	(R50, R53) One, Cooper & Cooper S	02 on	Rear	↔	
69110	Gas Ryder		⊕ 6.2	Volvo	S40	Excl. T4 rear (Mk I)	00-04	Rear	↔	
69117	Gas Ryder	NEW	‡ 3.2	Jeep (Chrysler)	Jeep	Patriot (MK) SUV	07 on	Rear	↔	
				Dodge (Chrysler)	Caliber	Hatch	06-12	Rear	↔	
69119	Gas Ryder	NEW	‡ 1.1	Audi	A4	B8 (excl. Sport Susp., Quattro & S4)	08 on	Front	↔	
69120	Gas Ryder	NEW	‡ 3.2	Honda	CR-V	SUV 4X4 (Mk III)	07-12	Rear	↔	
69121	Gas Ryder	NEW	⊕ 6.2	BMW	5 Series	E60 Series Sedan	04-10	Rear	↔	

PARTS LISTING

Shocks & Struts

69122



69122 - 69744

Part #	Range	Superceding Part #/Status.	Product Type	Make	Model	Derivative	Year	Position	L/R	Note # (pg 6)
69122	Gas Ryder	NEW	≠ 3.2	Toyota	Tercel	(Starlet) (EL4 / NL4)	90-96	Rear	↔	
69123	Gas Ryder	NEW	⊗ 0	Toyota	Chaser	(Mk II) (G100)	92-02	Rear	↔	
69401	Gas Ryder		⊗ 8.5	Peugeot	206	1.4, 1.6	01-06	Rear	↔	
69412	Gas Ryder		⊗ 8.5	Hyundai	Atoz	Mk I	97-98	Rear	↔	
69415	Gas Ryder		⊗ 8.5	Opel	Zafira	A	01-06	Rear	↔	
69422	Gas Ryder		⊕ 6.2	Ford	Focus	Mk I Hatch & Sedan	98-04	Rear	↔	
69423	Gas Ryder		⊖ 13.2	Ford	Escort	Mk V	95-99	Rear	↔	
69425	Gas Ryder		⊕ 6.2	Renault	Clio	Clio II 1.6 16V Sport	00-06	Rear	↔	
69431	Gas Ryder		⊗ 8.5	Daewoo	Matiz	Spark	99-03	Rear	↔	
69444	Gas Ryder		⊗ 8.5	Mercedes-Benz	A Class	(W168) A160, A190, 170CDI	00-04	Rear	↔	
69446	Gas Ryder		⊗ 8.5	Peugeot	206	1.4HDi, 2.0HDi	04-07	Rear	↔	
				Peugeot	206	1.6 Estate	03-07	Rear	↔	
				Peugeot	206	2.0 GTi	00-06	Rear	↔	
				Peugeot	206	CC 1.6, CC 2.0	01-07	Rear	↔	
69460	Gas Ryder	OBS.	⊕ 6.2	Opel	Senator	3.0i 24V	87-94	Rear	↔	
69487	Gas Ryder	G45879	⊕ 6.2	Volkswagen	Polo	Mk IV	02-09	Rear	↔	
69506	Gas Ryder	NEW	⊕ 6.2	Volkswagen	Touran	Typ 1T	04-10	Rear	↔	
69507	Gas Ryder		⊕ 6.2	Audi	A3	3-Door (8P1)	04 on	Rear	↔	
				Audi	A3	Sportback 4X2, Sportback Quattro 4X4 (8PA)	05 on	Rear	↔	
69512	Gas Ryder		⊗ 11	Renault	Scenic	Scenic II	04-09	Rear	↔	
69538	Gas Ryder		⊗ 11	Renault	Megane	II Hatch (Excl. 2.0 T Sport)	04-08	Rear	↔	
69538	Gas Ryder		⊗ 11	Renault	Megane	II Sedan (Excl. 2.0 T Sport)	04-08	Rear	↔	
69614	Gas Ryder	OBS.	⊕ 6	Porsche	9 Series	911	72-86	Rear	↔	
69616	Gas Ryder	OBS.	⊗ 8.5	Porsche	9 Series	924	76-85	Rear	↔	
				Porsche	9 Series	944	81-85	Rear	↔	
69633	Gas Ryder	OBS.	⊕ 6.2	Ford	Mustang	Mk III	79-84	Rear	↔	
69654	Gas Ryder	OBS.	⊕ 5	Renault	Fuego	3-Door Hatchback	80-85	Rear	↔	
69664	Gas Ryder	OBS.	⊕ 6.2	Ford	Falcon, Fairlane	Futura, Fairmont	96-99	Rear	↔	
				Ford	Falcon, Fairlane	Futura, Fairmont (Without ind Susp.)	99-03	Rear	↔	
69674	Gas Ryder	OBS.	⊕ 6.2	Mazda	RX7	Coupe	81-85	Rear	↔	
69677	Gas Ryder		⊕ 6.2	Jaguar	Jaguar	XJ6, XJ12 (4 shocks at rear)	70-87	Front	↔	
69689	Gas Ryder	OBS.	⊗ 8.5	Hyundai	Scoupe	Coupe	94-96	Rear	↔	
69742	Gas Ryder	OBS.	⊕ 5	Ford	Falcon, Fairlane	Futura, Fairmont	96-99	Rear	↔	
				Ford	Ranchero	Falcon	97-98	Rear	↔	
69744	Gas Ryder		⊕ 6.2	Mercedes-Benz	C Class	(W201) 190E (Excl. ⓈI)	83-94	Rear	↔	
				Mercedes-Benz	C Class	(W124) 200, 230E, 260E, 300D, 300E (Excl. ⓈI)	86-95	Rear	↔	



69760

PARTS LISTING

Shocks & Struts

69760 – 69965

Part #	Range	Superceding Part #/Status.	Product Type	Make	Model	Derivative	Year	Position	L/R	Note # (pg 6)
69760	Gas Ryder	OBS.	☉ 8.5	Porsche	9 Series	944	86-88	Rear	↔	
69769	Gas Ryder	OBS.	☉ 8.5	Suzuki	Carry	Mk VIII	82-85	Rear	↔	
69807	Gas Ryder	69744	☽ 6.2	Mercedes-Benz	C Class	(W201) 190E (Excl. ☉I)	83-94	Rear	↔	
				Mercedes-Benz	E Class	(W124) 200, 230E, 260E, 300D, 300E (Excl. ☉I)	86-95	Rear	↔	
69891	Gas Ryder	OBS.	☽ 6.2	Saab	9-3	SE 2.0, 2.0 Turbo, 2.3 (Mk I)	98-04	Rear	↔	
69901	Gas Ryder		☽ 6.2	Volvo	850	Excl. ☉I, ☉	94-97	Rear	↔	
				Volvo	850	Excl. ☉I, ☉	94-97	Rear	↔	
				Volvo	C70	Excl. T5 (Mk I)	97-00	Rear	↔	
				Volvo	S70, V70	Excl. ☉I, ☉	97-00	Rear	↔	
69914	Gas Ryder	OBS.	☉ 8.5	Fiat	Ulysse	Eurovan	99-03	Rear	↔	
				Peugeot	806	Eurovan MPV	95-03	Rear	↔	
69919	Gas Ryder		☉ 8.5	Alfa-Romeo	155	2.0 (Excl. ☉)	96-98	Rear	↔	
				Alfa-Romeo	155	2.5 (Excl. ☉)	96-98	Rear	↔	
				Fiat	Palio	Weekend (Type 2G)	02 on	Rear	↔	
				Fiat	Palio	Weekend (Type PY)	00-02	Rear	↔	
69921	Gas Ryder		☉ 8.5	Fiat	Seicento	600	99-03	Rear	↔	
69922	Gas Ryder	OBS.	☉ 8.5	Ford	Mondeo	Mk II (Excl. self levelling)	96-01	Rear	↔	
				Ford	Mondeo	Mk III (Excl. self levelling)	01-05	Rear	↔	
69924	Gas Ryder		☉ 8.5	Volkswagen	Sharan	Mk I, Mk IA, Mk IB	95-10	Rear	↔	
69926	Gas Ryder		☽ 6.2	Peugeot	406	Saloon	96-04	Rear	↔	
69927	Gas Ryder	62041	☉ 8.5	Renault	Megane	I (Excl. Coupe)	96-03	Rear	↔	
69928	Gas Ryder	62035	☉ 6.2	Renault	Scenic	Scenic I (Excl. 4X4)	98-04	Rear	↔	
69932	Gas Ryder	OBS.	☉ 8.5	Renault	Laguna	I (Excl. Station Wagon)	96-00	Rear	↔	
69935	Gas Ryder	OBS.	☉ 8.5	Alfa-Romeo	145, 146	2.0	96-99	Rear	↔	
69938	Gas Ryder	OBS.	☉ 8.4	Renault	Espace	III	97-04	Rear	↔	
69940	Gas Ryder	OBS.	☽ 6.2	Peugeot	406	SW	96-02	Rear	↔	
69946	Gas Ryder		☽ 6.2	Audi	A6	Excl. ☉I & Quattro (C5)	97-04	Rear	↔	
				Volkswagen	Passat	1.6, 1.8, 1.8T, 2.0, 1.9TDI Excl. 4X4 (B5)	96-99	Rear	↔	
				Volkswagen	Passat	2.3VR5 Excl. 4X4 (B5)	99-05	Rear	↔	
				Volkswagen	Passat	2.8 V6 (B5)	99-05	Rear	↔	
69948	Gas Ryder		☽ 6.2	BMW	Z3	E36/4	98-03	Rear	↔	
69952	Gas Ryder		☽ 6.2	Mercedes-Benz	E Class	(W210) E200, E220D, E280, E280TD, E290TD (Excl. ☉, ☉)	95-02	Front	↔	
				Mercedes-Benz	E Class	(W210) E230, E250D	95-99	Front	↔	
69953	Gas Ryder	OBS.	☽ 6.2	Mercedes-Benz	E Class	(W210) E230, E250D	95-99	Rear	↔	
69956	Gas Ryder	OBS.	☽ 6.2	Mercedes-Benz	SLK Series	R170	96-04	Front	↔	
69957	Gas Ryder	OBS.	☽ 6.2	Mercedes-Benz	SLK Series	R170	96-04	Rear	↔	
69965	Gas Ryder		☉ 8.5	Citroen	Xsara	Mark 2 (Excl. VTS)	00-06	Rear	↔	
				Peugeot	306	Hatchback, Saloon & Cabriolet (Excl. Estate)	93-02	Rear	↔	

PARTS LISTING

Shocks & Struts

69966



Part #	Range	Superceding Part #/Status.	Product Type	Make	Model	Derivative	Year	Position	L/R	Note # (pg 6)
69966	Gas Ryder		1/8 6.2	Mercedes-Benz	E Class	(W210) E200, E220D, E280, E280TD, E290TD (Excl. 1/2, Y)	95-02	Rear	↔	
69983	Gas Ryder	OBS.	8/8 11	Alfa-Romeo	GTV, Spider	2.0 TS	95-05	Rear	↔	
				Alfa-Romeo	GTV, Spider	3.0 V6	95-05	Rear	↔	
69986	Gas Ryder	G45881	8/8 8.5	Opel	Astra	Excl. 2.0 OPC (G)	99-03	Rear	↔	
				Opel	Astra	Excl. 2.0 OPC (G)	99-03	Rear	↔	
69987	Gas Ryder		8/8 8.5	Opel	Astra	Caravan, Excl. 2.0 OPC (G)	98-04	Rear	↔	
69989	Gas Ryder		1/8 6.2	Renault	Clio	Clio II 1.4, 1.5dCi & 1.6 (Excl. 1.2, 1.6 Sport, 2.0 & 3.0)	00-06	Rear	↔	
70500	Gas Ryder		1/1 1.1	Nissan	Almera	Excl. ABS (N16)	01-07	Front	L	
70501	Gas Ryder		1/1 1.1	Nissan	Almera	Excl. ABS (N16)	01-07	Front	R	
70503	Gas Ryder		1/1 1.1	Volkswagen	Polo	Mk IV	02-09	Front	↔	
70504	Gas Ryder		1/1 1.1	Opel	Corsa	Excl. Corsa Lite (C)	02-07	Front	↔	
70505	Gas Ryder		1/1 1.1	Opel	Astra	Caravan, Excl. 2.0 OPC (G)	98-04	Front	↔	
				Opel	Astra	Excl. 2.0 OPC (G)	99-03	Front	↔	
				Opel	Astra	Excl. 2.0 OPC (G)	99-03	Front	↔	
70506	Gas Ryder	NEW	1/1 1.1	Mercedes-Benz	Sprinter	Panel van (Excl. 312, 515, 518 & 519)	06 on	Front	↔	
				Volkswagen	Crafter	3 Ton, 3, 5 Ton (Excl. 4X4 & 5 Ton) (LT3)	06 on	Front	↔	
70508	Gas Ryder		1/1 1.1	BMW	3 Series	E46 Series (Excl. M3, Y + Touring) one pin at the bottom strut mounting	99-05	Front	L	24
70509	Gas Ryder		1/1 1.1	BMW	3 Series	E46 Series (Excl. M3, Y + Touring) one pin at the bottom strut mounting	99-05	Front	R	24
70510	Gas Ryder		1/1 1.1	Ford	Bantam	1.3, 1.6	03-06	Front	↔	
				Ford	Bantam	1.3, 1.6 (Mk III)	06 on	Front	↔	
				Ford	Bantam	1.3, 1.6, 1.8D	02	Front	↔	
70511	Gas Ryder		1/1 1.1	Renault	Megane	I (Excl. Coupe)	96-03	Front	↔	
				Renault	Scenic	Scenic I (Excl. 4X4)	98-04	Front	↔	
70512	Gas Ryder		1/1 1.1	Renault	Clio	Clio II 1.4, 1.5dCi & 1.6 (Excl. 1.2, 1.6 Sport, 2.0 & 3.0)	00-06	Front	↔	
70517	Gas Ryder	OBS.	1/1 1.1	Kia	Sedona/Carnival	Mk I	99-06	Front	L	
70518	Gas Ryder	OBS.	1/1 1.1	Kia	Sedona/Carnival	Mk I	99-06	Front	R	
70519	Gas Ryder		1/1 1.1	Hyundai	Elantra	J2 & J3 Series (Avante)	96-00	Front	L	
				Hyundai	Elantra	XD (J4) (Avante)	01-07	Front	L	
				Hyundai	Tiburon	RC	96-00	Front	L	
70520	Gas Ryder		1/1 1.1	Hyundai	Elantra	J2 & J3 Series (Avante)	96-00	Front	R	
				Hyundai	Elantra	XD (J4) (Avante)	01-07	Front	R	
				Hyundai	Tiburon	RC	96-00	Front	R	
70521	Gas Ryder		1/1 1.1	Hyundai	Elantra	XD (J4) (Avante)	01-07	Rear	L	
70522	Gas Ryder		1/1 1.1	Hyundai	Elantra	XD (J4) (Avante)	01-07	Rear	R	
70523	Gas Ryder		1/1 1.1	Toyota	Rav4	Sealed struts (XA10)	98-00	Front	L	
70524	Gas Ryder		1/1 1.1	Toyota	Rav4	Sealed struts (XA10)	98-00	Front	R	

69966 - 70524



Part #	Range	Superceding Part #/Status.	Product Type	Make	Model	Derivative	Year	Position	L/R	Note # (pg 6)	
70525	Gas Ryder	OBS.	J	1.1	Kia	Carens	Mk I	99-06	Rear	L	
					Kia	Shuma	I.6, 1.8 (Shuma I)	97-02	Rear	L	
					Kia	Shuma	I.6, 1.8 (Shuma II)	02-04	Rear	L	
70526	Gas Ryder	OBS.	J	1.1	Kia	Carens	Mk I	99-06	Rear	R	
					Kia	Shuma	I.6, 1.8 (Shuma I)	97-02	Rear	R	
					Kia	Shuma	I.6, 1.8 (Shuma II)	02-04	Rear	R	
70527	Gas Ryder		J	1.1	Opel	Corsa	Utility	04 on	Front	←→	
70528	Gas Ryder	35941	J	1.1	Chevrolet	Aveo	T200 (Kalos)	02 on	Front	L	
70529	Gas Ryder	35942	J	1.1	Chevrolet	Aveo	T200 (Kalos)	02 on	Front	R	
70530	Gas Ryder		J	1.1	Hyundai	Matrix	(Lavita) Mini MPV	02 on	Rear	L	
70531	Gas Ryder		J	1.1	Hyundai	Matrix	(Lavita) Mini MPV	02 on	Rear	R	
70532	Gas Ryder	OBS.	J	1.1	Daihatsu	Gran Move	Pyzar	97-01	Rear	L	
70533	Gas Ryder	OBS.	J	1.1	Daihatsu	Gran Move	Pyzar	97-01	Rear	R	
70534	Gas Ryder	OBS.	J	1.1	Daihatsu	Gran Move	Pyzar	97-01	Front	L	
70535	Gas Ryder	OBS.	J	1.1	Daihatsu	Gran Move	Pyzar	97-01	Front	R	
70536	Gas Ryder	OBS.	J	1.1	Kia	Carens	Mk I	99-06	Front	L	
70537	Gas Ryder	OBS.	J	1.1	Kia	Carens	Mk I	99-06	Front	R	
70538	Gas Ryder		J	1.1	Mercedes-Benz	Vito	112 Cdi Bus	03-04	Front	←→	
					Mercedes-Benz	Vito	112 CDi 2.2 Cr-Cab Panel Van Diesel	03	Front	←→	
					Mercedes-Benz	Vito	112 CDi 2.2 Panel Van Diesel	02-04	Front	←→	
70539	Gas Ryder		J	1.1	Peugeot	206	1.4, 1.6	01-06	Front	L	
70540	Gas Ryder		J	1.1	Peugeot	206	1.4, 1.6	01-06	Front	R	
70542	Gas Ryder		J	1.1	BMW	X5	E53 3.0i, 3.0d, 4.4iV8, 4.8 V8 4X4	01-07	Front	L	
70543	Gas Ryder		J	1.1	BMW	X5	E53 3.0i, 3.0d, 4.4iV8, 4.8 V8 4X4	01-07	Front	R	
70544	Gas Ryder		J	1.1	Hyundai	Elantra	J2 & J3 Series (Avante)	96-00	Rear	L	
70545	Gas Ryder		J	1.1	Hyundai	Elantra	J2 & J3 Series (Avante)	96-00	Rear	R	
70546	Gas Ryder		J	1.1	Audi	A3	50mm Strut Body. All (8P1) - Excl. Quattro, Sport Susp. & S3.	03-12	Front	←→	
					Audi	A3	50mm Strut Body. Sportback (8PA) Excl. Quattro, Sport Susp. & S3.	05-12	Front	←→	
					Volkswagen	Caddy	All 50mm OD strut	04 on	Front	←→	
					Volkswagen	Golf	Mk V 50mm Strut Body (Excl. GTi)	04-09	Front	←→	
					Volkswagen	Golf	Mk V 50mm Strut Body (Excl. GTi)	09 on	Front	←→	
					Volkswagen	Jetta	Mk V 50mm OE Strut Body (Excl. V5 & Sport Susp.)	06-11	Front	←→	
70547	Gas Ryder	70608	J	1.1	Toyota	Yaris	T1 1.0L, T3 1.3L (Mk II) Hatch & T3 1.3L (Mk II) Sedan	05-11	Front	L	
					Toyota	Yaris	T1 1.0L, T3 1.3L (Mk II) Hatch & T3 1.3L (Mk II) Sedan	05-11	Front	R	



Part #	Range	Superceding Part #/Status.	Product Type	Make	Model	Derivative	Year	Position	L/R	Note # (pg 6)
70548	Gas Ryder		f 1.1	Hyundai	Getz	3 & 5-Door	03 on	Front	L	
70549	Gas Ryder		f 1.1	Hyundai	Getz	3 & 5-Door	03 on	Front	R	
70550	Gas Ryder		f 1.1	Hyundai	Matrix	(Lavita) Mini MPV	02 on	Front	L	
70551	Gas Ryder		f 1.1	Hyundai	Matrix	(Lavita) Mini MPV	02 on	Front	R	
70554	Gas Ryder		f 1.1	Hyundai	Santa Fe	SM	01-06	Front	L	
70555	Gas Ryder		f 1.1	Hyundai	Santa Fe	SM	01-06	Front	R	
70556	Gas Ryder		f 1.1	Nissan	X-Trail	4X4 & 4X2 (Mk I)	01-07	Front	L	
70557	Gas Ryder		f 1.1	Nissan	X-Trail	4X4 & 4X2 (Mk I)	01-07	Front	R	
70558	Gas Ryder		f 1.1	Nissan	X-Trail	4X4 & 4X2 (Mk I)	01-07	Rear	L	
70559	Gas Ryder		f 1.1	Nissan	X-Trail	4X4 & 4X2 (Mk I)	01-07	Rear	R	
70560	Gas Ryder		f 1.1	Volkswagen	Caddy	All 55mm OD strut	04 on	Front	↔	
				Volkswagen	Golf	Mk V 55mm Strut Body (Excl. GTi)	04-09	Front	↔	
				Volkswagen	Golf	Mk V 55mm Strut Body (Excl. GTi)	09 on	Front	↔	
				Volkswagen	Jetta	Mk V 55mm OE Strut Body (Excl. V5 & Sport Susp.)	06-11	Front	↔	
				Volkswagen	Passat	B6 All (Excl. Sport Susp. & 4WD 4-Motion Syncro)	05-11	Front	↔	
70561	Gas Ryder		f 1.1	Toyota	Auris	1.4 & 1.6 (330N)	07-12	Front	L	
				Toyota	Corolla	1.3, 1.4, 1.6, 1.8, & 2.0 D4D (E140, E150)	07 on	Front	L	
70562	Gas Ryder		f 1.1	Toyota	Auris	1.4 & 1.6 (330N)	07-12	Front	R	
				Toyota	Corolla	1.3, 1.4, 1.6, 1.8, & 2.0 D4D (E140, E150)	07 on	Front	R	
70563	Gas Ryder		f 1.1	Chevrolet	Optra (Lacetti)	1.6 & 1.8 (Mk I)	02-08	Front	L	
70564	Gas Ryder		f 1.1	Chevrolet	Optra (Lacetti)	1.6 & 1.8 (Mk I)	02-08	Front	R	
70565	Gas Ryder		f 1.1	Chevrolet	Optra (Lacetti)	1.6 & 1.8 (Mk I)	02-08	Rear	R	
70566	Gas Ryder		f 1.1	Chevrolet	Optra (Lacetti)	1.6 & 1.8 (Mk I)	02-08	Rear	L	
70567	Gas Ryder		f 1.1	Ford	Fiesta	Mark V Hatch & Sedan	02-08	Front	L	
				Ford	Figo	1.4	10 on	Front	L	
				Ford	Ikon	Sedan All	07 on	Front	L	
				Mazda	Demio	Hatch DY	02-07	Front	L	
70568	Gas Ryder		f 1.1	Ford	Fiesta	Mark V Hatch & Sedan	02-08	Front	R	
				Ford	Figo	1.4	10 on	Front	R	
				Ford	Ikon	Sedan All	07 on	Front	R	
				Mazda	Demio	Hatch DY	02 on	Front	R	
				Mazda	Mazda 2	Hatch DY (Demio)	02-07	Front	R	
70569	Gas Ryder		f 1.1	Hyundai	i10	Hatch	08 on	Front	L	
				Kia	Picanto	Mk I Incl. 2007 & 2010 facelift (SA)	04-11	Front	L	
70570	Gas Ryder		f 1.1	Hyundai	i10	Hatch	08 on	Front	R	
				Kia	Picanto	Mk I Incl. 2007 & 2010 facelift (SA)	04-11	Front	R	



70571

PARTS LISTING

Shocks & Struts

70571 - 70577

Part #	Range	Superceding Part #/Status.	Product Type	Make	Model	Derivative	Year	Position	L/R	Note # (pg 6)
70571	Gas Ryder		1.1	Toyota	Corona/Caldina	ST210, CT210 2.0 & 2.0 Diesel Sedan	01.96-12.01	Front	L	
				Toyota	Corona/Caldina	ST215G/W (2.0 & 2.0 Turbo 4WD GT & GTT)	12.99-09.02	Front	L	
				Toyota	Corona/Carina e	AT190, ST191, CT190 Sedan made in the UK	01.96-10.97	Front	L	
				Toyota	Corona/Carina e	ST191 2.0 Station Wagon	11.92-01.96	Front	L	
				Toyota	Corona/Carina e	ST191, CT190 2.0 & 2.0 Diesel Sedan & LB:5-Door Hatchback	03.92-05.98	Front	L	
				Toyota	Corona/Carina e	ST191, CT190 2.0 & 2.0 Diesel Sedan & LB:5-Door Hatchback with Harsh Road Package	02.96-05.98	Front	L	
70572	Gas Ryder		1.1	Toyota	Corona/Caldina	ST210, CT210 2.0 & 2.0 Diesel Sedan	01.96-12.01	Front	R	
				Toyota	Corona/Caldina	ST215G/W (2.0 & 2.0 Turbo 4WD GT & GTT)	12.99-09.02	Front	R	
				Toyota	Corona/Carina e	AT190, ST191, CT190 Sedan made in the UK	01.96-10.97	Front	R	
				Toyota	Corona/Carina e	ST191 2.0 Station Wagon	11.92-01.96	Front	R	
				Toyota	Corona/Carina e	ST191, CT190 2.0 & 2.0 Diesel Sedan & LB:5-Door Hatchback	03.92-05.98	Front	R	
				Toyota	Corona/Carina e	ST191, CT190 2.0 & 2.0 Diesel Sedan & LB:5-Door Hatchback with Harsh Road Package	02.96-05.98	Front	R	
70573	Gas Ryder		1.1	Toyota	Corona/Caldina	ST210, CT210 2.0 & 2.0 Diesel Sedan	01.96-12.01	Rear	L	
				Toyota	Corona/Carina e	ST191 2.0 Sedan & LB:5-Door Hatchback	03.92-02.96	Rear	L	
				Toyota	Corona/Carina e	ST191, CT190 2.0 & 2.0 Diesel Sedan & LB:5-Door Hatchback	03.92-05.98	Rear	L	
70574	Gas Ryder		1.1	Toyota	Corona/Caldina	ST210, CT210 2.0 & 2.0 Diesel Sedan	01.96-12.01	Rear	R	
				Toyota	Corona/Carina e	ST191 2.0 Sedan & LB:5-Door Hatchback	03.92-02.96	Rear	R	
				Toyota	Corona/Carina e	ST191, CT190 2.0 & 2.0 Diesel Sedan & LB:5-Door Hatchback	03.92-05.98	Rear	R	
70575	Gas Ryder		1.1	Nissan	Micra	5-Door (K12)	04 on	Front	L	
70576	Gas Ryder		1.1	Nissan	Micra	5-Door (K12)	04 on	Front	R	
70577	Gas Ryder		1.1	BMW	1 Series	E81 3-Door ((Excl. Sport Susp. &135i)	07-11	Front	L	
				BMW	1 Series	E82 Coupe (Excl. Sport Susp. &135i)	08 on	Front	L	
				BMW	1 Series	E87 5-Door (Excl. Sport Susp. &135i)	04-11	Front	L	
				BMW	1 Series	E88 Cabriolet (Excl. Sport Susp. &135i)	08 on	Front	L	
				BMW	3 Series	E90 Series (Excl. M3, Y)	05-12	Front	L	

PARTS LISTING

Shocks & Struts

70578



Part #	Range	Superceding Part #/Status.	Product Type	Make	Model	Derivative	Year	Position	L/R	Note # (pg 6)	
70578	Gas Ryder		f	1.1	BMW	1 Series	E81 3-Door ((Excl. Sport Susp. &135i)	07-11	Front	R	
					BMW	1 Series	E82 Coupe (Excl. Sport Susp. &135i)	08 on	Front	R	
					BMW	1 Series	E87 5-Door (Excl. Sport Susp. &135i)	04-11	Front	R	
					BMW	1 Series	E88 Cabriolet (Excl. Sport Susp. &135i)	08 on	Front	R	
					BMW	3 Series	E90 Series (Excl. M3, Y)	05-12	Front	R	
70579	Gas Ryder		f	1.1	Toyota	Avanza	1.3 & 1.5 (Xenia)	06 on	Front	L	
70580	Gas Ryder		f	1.1	Toyota	Avanza	1.3 & 1.5 (Xenia)	06 on	Front	R	
70581	Gas Ryder		f	1.1	Volkswagen	Golf	Mk V 2.0 GTi	04-09	Front	↔	
70583	Gas Ryder		f	1.1	Fiat	Palio	Expresso Panel van	02 on	Front	↔	
					Fiat	Palio	Type 2H	02 on	Front	↔	
70584	Gas Ryder		f	1.1	Ford	Focus	Mk II Hatch & Sedan (Excl. Sti)	04-11	Front	L	
70585	Gas Ryder		f	1.1	Ford	Focus	Mk II Hatch & Sedan (Excl. Sti)	04-11	Front	R	
70586	Gas Ryder		f	1.1	Nissan	NP200	1.5, 1.6	08 on	Front	↔	
70587	Gas Ryder		f	1.1	BMW	3 Series	E36 Series (Imported Excl. M-Series) 320i, 325i, 325td (long Stud)	91-92	Front	L	
70588	Gas Ryder		f	1.1	BMW	3 Series	E36 Series (Imported Excl. M-Series) 320i, 325i, 325td (long Stud)	91-92	Front	R	
70589	Gas Ryder		f	1.1	Nissan	Livina	Incl. X-Gear & Grand Livina (XJ)	06-14	Front	L	
					Nissan	Tiida	1.6i & 1.8i Hatch & Sedan	06 on	Front	L	
70590	Gas Ryder		f	1.1	Nissan	Livina	Incl. X-Gear & Grand Livina (XJ)	06-14	Front	R	
					Nissan	Tiida	1.6i & 1.8i Hatch & Sedan	06 on	Front	R	
70591	Gas Ryder		f	1.1	Volkswagen	Kombi	T5 Transporter: Caravelle, Crew bus, Pick-up & Panel van (Excl. 4-Motion)	04 on	Front	↔	
70592	Gas Ryder		f	1.1	Mazda	Mazda 3	1.6, 2.0 Excl. 2.3 MPS (Mk I)	04-09	Front	L	
70593	Gas Ryder		f	1.1	Mazda	Mazda 3	1.6, 2.0 Excl. 2.3 MPS (Mk I)	04-09	Front	R	
70594	Gas Ryder		f	1.1	Fiat	Strada	3/4 Ton LDV (Mk II)	05 on	Front	↔	
70596	Gas Ryder		f	1.1	Chevrolet	Spark	M300 (Excl. Lite)	10 on	Front	L	
70597	Gas Ryder		f	1.1	Chevrolet	Spark	M300 (Excl. Lite)	10 on	Front	R	
70598	Gas Ryder		f	1.1	Honda	Civic	Mk VIII	05-07	Front	L	
70599	Gas Ryder		f	1.1	Honda	Civic	Mk VIII	05-07	Front	R	
70600	Gas Ryder		f	1.1	Honda	Civic	Mk VIII	05-07	Front	L	
70601	Gas Ryder		f	1.1	Ford	Fiesta	Mk VI	08 on	Front	R	
					Mazda	Mazda 2	Hatch DE (Demio)	07 on	Front	R	
70602	Gas Ryder		f	2.1	Mercedes-Benz	C Class	(W203) C180, C200, C220CDi, C230, C270CDi, C280, C320CDi, C350	00-07	Front	↔	
70608	Gas Ryder		f	1.1	Toyota	Yaris	T1 1.0L, T3 1.3L (Mk II) Hatch	05-11	Front	L	
70609	Gas Ryder		f	1.1	Toyota	Yaris	T3 1.3L (Mk II) Sedan	06-11	Front	R	

70578 - 70609



Part #	Range	Superceding Part #/Status.	Product Type	Make	Model	Derivative	Year	Position	L/R	Note # (pg 6)
70610	Gas Ryder		1.1	Honda	Jazz	1.4Dsi, 1.5 Gen 1	03-07	Front	L	
70611	Gas Ryder		1.1	Honda	Jazz	1.4Dsi, 1.5 Gen 1	03-07	Front	R	
70612	Gas Ryder		1.1	Honda	CR-V	Mk II 4X4 2.0, 2.2D	00-04	Front	L	
70613	Gas Ryder		1.1	Honda	CR-V	Mk II 4X4 2.0, 2.2D	00-04	Front	R	
70616	Gas Ryder	NEW	1.1	Land Rover	Freelander	Mk I (1.8, 2.0Td4, 2.5V6)	98-3/07	Rear	L	
70617	Gas Ryder	NEW	1.1	Land Rover	Freelander	Mk I (1.8, 2.0Td4, 2.5V6)	98-3/07	Rear	R	
70618	Gas Ryder		1.1	Toyota	Verso	1.6, 1.8, 2.0 (Mk III) (Spacio)	04-09	Front	L	
70619	Gas Ryder		1.1	Toyota	Verso	1.6, 1.8, 2.0 (Mk III) (Spacio)	04-09	Front	R	
70620	Gas Ryder		1.1	Kia	Rio	1.3 & 1.6 (DC)	03-06	Front	L	
70621	Gas Ryder		1.1	Kia	Rio	1.3 & 1.6 (DC)	03-06	Front	R	
70624	Gas Ryder		1.1	Hyundai	Accent	LC. 1.6	00-05	Front	L	
70625	Gas Ryder		1.1	Hyundai	Accent	LC. 1.6	00-05	Front	R	
70628	Gas Ryder		1.1	Toyota	Rav4	XA20 (Mk II)	01-06	Front	L	
70629	Gas Ryder		1.1	Toyota	Rav4	XA20 (Mk II)	01-06	Front	R	
70631	Gas Ryder		1.1	Opel	Astra	(H) 1.8 & 1.9 CDTi Incl. GTC (Excl. 2.0 Turbo Sport & OPC)	04-09	Front	L	
70632	Gas Ryder		1.1	Opel	Astra	(H) 1.8 & 1.9 CDTi Incl. GTC (Excl. 2.0 Turbo Sport & OPC)	04-09	Front	R	
70633	Gas Ryder		1.1	Volvo	C30	Hatch	07 on	Front	L	
				Volvo	S40	Mk II Incl. T5	04-11	Front	L	
70634	Gas Ryder		1.1	Volvo	C30	Hatch	07 on	Front	R	
				Volvo	S40	Mk II Incl. T5	04-11	Front	R	
70635	Gas Ryder		2.1	Hyundai	Tucson	All	04-11	Front	L	
				Kia	Sportage	2.0, 2.7, 2.0D (Mk II)	04-10	Front	L	
70636	Gas Ryder		4.1	Hyundai	Tucson	All	04-11	Front	R	
				Kia	Sportage	2.0, 2.7, 2.0D (Mk II)	04-10	Front	R	
70637	Gas Ryder		6.1	Hyundai	Tucson	All	04-11	Rear	L	
				Kia	Sportage	2.0, 2.7, 2.0D (Mk II)	04-10	Rear	L	
70638	Gas Ryder		8.1	Hyundai	Tucson	All	04-11	Rear	R	
				Kia	Sportage	2.0, 2.7, 2.0D (Mk II)	04-10	Rear	R	
70639	Gas Ryder		1.1	Renault	Logan	U 90	08 on	Front	↔	
				Renault	Sandero	5-Door Hatchback	09-14	Front	↔	
70640	Gas Ryder	NEW	1.1	Audi	A3	55mm Strut Body. All (8P1) - Excl. Quattro, Sport Susp. & S3.	03-12	Front	↔	
				Audi	A3	55mm Strut Body. Sportback (8PA) Excl. Quattro, Sport Susp. & S3.	05-12	Front	↔	
70642	Gas Ryder	NEW	1.1	BMW	X3	E83 2.5i, 3.0i, 2.0d & 3.0d	04 on	Front	L	
70643	Gas Ryder	NEW	1.1	BMW	X3	E83 2.5i, 3.0i, 2.0d & 3.0d	04 on	Front	R	
70648	Gas Ryder	NEW	1.1	Honda	Civic	Mk VII Sedan	01-05	Front	L	
70649	Gas Ryder	NEW	1.1	Honda	Civic	Mk VII Sedan	01-05	Front	R	
70654	Gas Ryder	NEW	1.1	Mazda	626	1.8, 2.0 (Mk V), Y5 Sedan	99-03	Front	L	
70655	Gas Ryder	NEW	1.1	Mazda	626	1.8, 2.0 (Mk V), Y5 Sedan	99-03	Front	R	
70656	Gas Ryder	NEW	1.1	Mazda	626	1.8, 2.0 (Mk V), Y5 Sedan	99-03	Rear	L	

PARTS LISTING

Shocks & Struts

70657



Part #	Range	Superceding Part #/Status.	Product Type	Make	Model	Derivative	Year	Position	L/R	Note # (pg 6)
70657	Gas Ryder	NEW	f 1.1	Mazda	626	1.8, 2.0 (Mk V), Y5 Sedan	99-03	Rear	R	
70661	Gas Ryder	NEW	f 1.1	Nissan	Qashqai	1.6, 2.0, 1.5DCI (J10, JJ10)	07-14	Front	L	
70662	Gas Ryder	NEW	f 1.1	Nissan	Qashqai	1.6, 2.0, 1.5DCI (J10, JJ10)	07-14	Front	R	
70663	Gas Ryder		f 8.5	Nissan	X-Trail	4X4 & 4X2 (Mk II)	08 on	Front	L	
70664	Gas Ryder		f 8.5	Nissan	X-Trail	4X4 & 4X2 (Mk II)	08 on	Front	R	
70677	Gas Ryder	NEW	f 1.1	Land Rover	Freelander	Mk II (L359)	4/07-on	Rear	L	
70678	Gas Ryder	NEW	f 1.1	Land Rover	Freelander	Mk II (L359)	4/07-on	Rear	R	
70679	Gas Ryder	NEW	f 1.1	Mini	Cooper	(R50, R53) One, Cooper & Cooper S	02 on	Front	L	
70680	Gas Ryder	NEW	f 1.1	Mini	Cooper	(R50, R53) One, Cooper & Cooper S	02 on	Front	R	
70682	Gas Ryder	NEW	f 1.1	Renault	Clio	Clio III Hatch	06-13	Front	↔	
70683	Gas Ryder		f 1.1	Volvo	S40	Excl. & T4 rear (Mk I)	00-04	Front	L	
70684	Gas Ryder		f 1.1	Volvo	S40	Excl. & T4 rear (Mk I)	00-04	Front	R	
70687	Gas Ryder	NEW	f 1.1	Suzuki	SX4	SX4	08 on	Front	L	
70688	Gas Ryder	NEW	f 1.1	Suzuki	SX4	SX4	08 on	Front	R	
				Land Rover	Freelander	Mk II (L359)	4/07-on	Rear	R	
70689	Gas Ryder	NEW	f 1.1	Suzuki	Swift	Hatch	08 on	Front	L	
70690	Gas Ryder	NEW	f 1.1	Suzuki	Swift	Hatch	08 on	Front	R	
70691	Gas Ryder	NEW	1/2 7,1	Kia	Sportage	SUV 4X2	10 on	Front	L	
70692	Gas Ryder	NEW	9 7,1	Kia	Sportage	SUV 4X2	10 on	Front	R	
70696	Gas Ryder	NEW	f 1.1	Hyundai	i20	Hatch	09 on	Front	L	
70697	Gas Ryder	NEW	f 1.1	Hyundai	i20	Hatch	09 on	Front	R	
70700	Gas Ryder	NEW	f 1.1	Daihatsu	Sirion	(Mk II) (Boon) Hatch	05-10	Front	↔	
70701	Gas Ryder	NEW	f 1.1	Toyota	Avensis	Gen 2 (T250)	06-10	Front	L	
70702	Gas Ryder	NEW	f 1.1	Toyota	Avensis	Gen 2 (T250)	06-10	Front	R	
70703	Gas Ryder	NEW	f 1.1	Volkswagen	Touran	MPV	04 on	Front	↔	
70706	Gas Ryder	NEW	f 1.1	Opel	Corsa	(D) Hatch	07 on	Front	L	
70707	Gas Ryder	NEW	f 1.1	Opel	Corsa	(D) Hatch	07 on	Front	R	
70708	Gas Ryder	NEW	f 1.1	Chevrolet	Cruze	Sedan	09 on	Front	L	
70709	Gas Ryder	NEW	f 1.1	Chevrolet	Cruze	Sedan	09 on	Front	R	
70710	Gas Ryder	NEW	f 1.1	Fiat	Punto	Mk II	04-12	Front	↔	
70711	Gas Ryder	NEW	f 1.1	Jeep (Chrysler)	Jeep	Patriot (MK) SUV	07 on	Front	L	
				Dodge (Chrysler)	Caliber	Hatch	06-12	Front	L	
70712	Gas Ryder	NEW	f 1.1	Jeep (Chrysler)	Jeep	Patriot (MK) SUV	06-12	Front	R	
				Dodge (Chrysler)	Caliber	Hatch	06-12	Front	R	
70714	Gas Ryder	NEW	f 1.1	Volkswagen	Polo	Hatch	10 on	Front	↔	
				Volkswagen	Polo	Vivo Hatch	10 on	Front	↔	
				Volkswagen	Polo	Sedan	11 on	Front	↔	
				Volkswagen	Polo	Vivo Sedan	10 on	Front	↔	

70657 - 70714



70715 - 70755

Part #	Range	Superceding Part #/Status.	Product Type	Make	Model	Derivative	Year	Position	L/R	Note # (pg 6)
70715	Gas Ryder	NEW	↙ 1.1	Honda	Jazz	Hatch	08 on	Front	L	
70716	Gas Ryder	NEW	↙ 1.1	Honda	Jazz	Hatch	08 on	Front	R	
70718	Gas Ryder	NEW	↙ 1.1	Honda	CR-V	SUV 4X4 (Mk III)	07-12	Front	L	
70719	Gas Ryder	NEW	↙ 1.1	Honda	CR-V	SUV 4X4 (Mk III)	07-12	Front	R	
70725	Gas Ryder	NEW	↙ 1.1	Toyota	Ipsum	(SM10)	96-01	Front	L	
70726	Gas Ryder	NEW	↙ 1.1	Toyota	Ipsum	(SM10)	96-01	Front	R	
70727	Gas Ryder	NEW	↙ 1.1	Toyota	Camry	(Gen 5) (SV20)	96-01	Front	L	
70728	Gas Ryder	NEW	↙ 1.1	Toyota	Camry	(Gen 5) (SV20)	96-01	Front	R	
70729	Gas Ryder	NEW	↙ 1.1	Toyota	Harrier	SXU 10, SXU 15 (Gen 1)	97-03	Front	L	
70730	Gas Ryder	NEW	↙ 1.1	Toyota	Harrier	SXU 10, SXU 15 (Gen 1)	97-03	Front	R	
70731	Gas Ryder	NEW	↙ 1.1	Toyota	Spaceo	(AE114)	97-01	Front	L	
70732	Gas Ryder	NEW	↙ 1.1	Toyota	Spaceo	(AE114)	97-01	Front	R	
70733	Gas Ryder	NEW	↙ 1.1	Toyota	Spaceo	(AE114)	97-01	Rear	L	
70734	Gas Ryder	NEW	↙ 1.1	Toyota	Spaceo	(AE114)	97-01	Rear	R	
70735	Gas Ryder	NEW	↙ 1.1	Toyota	Harrier	XU 10 (Gen 1)	97-03	Rear	L	
70736	Gas Ryder	NEW	↙ 1.1	Toyota	Harrier	XU 10 (Gen 1)	97-03	Rear	R	
70737	Gas Ryder	NEW	↙ 1.1	Toyota	Harrier	SXU 15 (Gen 1)	97-03	Rear	L	
70738	Gas Ryder	NEW	↙ 1.1	Toyota	Harrier	SXU 15 (Gen 1)	97-03	Rear	R	
70739	Gas Ryder	NEW	↙ 1.1	Toyota	Tercel	(Starlet) (EL4 / NL4)	90-96	Front	L	
70740	Gas Ryder	NEW	↙ 1.1	Toyota	Tercel	(Starlet) (EL4 / NL4)	90-96	Front	R	
70741	Gas Ryder	NEW	↙ 1.1	Mazda	Familia	(BJ)	00-04	Front	L	
70742	Gas Ryder	NEW	↙ 1.1	Mazda	Familia	(BJ)	00-04	Front	R	
70743	Gas Ryder	NEW	↙ 1.1	Mazda	Familia	(BJ)	00-04	Rear	L	
70744	Gas Ryder	NEW	↙ 1.1	Mazda	Familia	(BJ)	00-04	Rear	R	
70745	Gas Ryder	NEW	↙ 1.1	Mazda	Familia	(BJE)	99-00	Front	L	
70746	Gas Ryder	NEW	↙ 1.1	Mazda	Familia	(BJE)	99-00	Front	R	
70747	Gas Ryder	NEW	↙ 1.1	Mazda	Familia	(BJE)	99-00	Rear	L	
70748	Gas Ryder	NEW	↙ 1.1	Mazda	Familia	(BJE)	99-00	Rear	R	
70749	Gas Ryder	NEW	↙ 1.1	Honda	Fit	(Gen 1) (GD1)	07 on	Front	L	
70750	Gas Ryder	NEW	↙ 1.1	Honda	Fit	(Gen 1) (GD1)	07 on	Front	R	
70751	Gas Ryder	NEW	↙ 1.1	Toyota	Yaris/Vitz	Yaris/Vitz	99-05	Front	←→	
70752	Gas Ryder	NEW	↙ 1.1	Toyota	Bubble	(1NZ)	02-07	Front	L	
70753	Gas Ryder	NEW	↙ 1.1	Toyota	Bubble	(1NZ)	02-07	Front	R	
70754	Gas Ryder	NEW	↙ 1.1	Toyota	Ipsum	(ACM 2)	01 on	Front	L	
70755	Gas Ryder	NEW	↙ 1.1	Toyota	Ipsum	(ACM 2)	01 on	Front	R	

PARTS LISTING

Shocks & Struts

70757



70757 - 76003

Part #	Range	Superceding Part #/Status.	Product Type	Make	Model	Derivative	Year	Position	L/R	Note # (pg 6)
70757	Gas Ryder	NEW	f 1.1	Chevrolet	Utility	Utility Pick-Up	11 on	Front	↔	
70759	Gas Ryder	NEW	f 3.3	Volkswagen	Amarok	Pick-Up 4X2	10 on	Front	↔	
				Volkswagen	Amarok	Pick-Up 4X4, 4X2 Raised	10 on	Front	↔	
70763	Gas Ryder	NEW	f 1.1	Peugeot	207	Hatch, CC 1.6 Sport 2 EU5, GT 1.6 3-Door	06 on	Front	L	
70764	Gas Ryder	NEW	f 1.1	Peugeot	207	Hatch, CC 1.6 Sport 2 EU5, GT 1.6 3-Door	06 on	Front	R	
70771	Gas Ryder	NEW	f 1.1	Ford	Focus	Mk III Hatch & Sedan (excl 2.5 ST & RS)	11 on	Front	L	
70772	Gas Ryder	NEW	f 1.1	Ford	Focus	Mk III Hatch & Sedan (excl 2.5 ST & RS)	11 on	Front	R	
70774	Gas Ryder	NEW	f 1.1	Volkswagen	Jetta	6 Sedan (50mm OD)	11 on	Front	↔	
70775	Gas Ryder	NEW	f 1.1	Volkswagen	Jetta	6 Sedan (55mm OD)	11 on	Front	↔	
70785	Gas Ryder	NEW	f 1.1	Volvo	S60	Sedan	00-10	Front	↔	
70786	Gas Ryder	NEW	f 1.1	Mercedes-Benz	E Class	(W212) Sedan	09 on	Front	↔	
70789	Gas Ryder	NEW	f 1.1	BMW	3 Series	E92 Series	07-14	Front	L	
70790	Gas Ryder	NEW	f 1.1	BMW	3 Series	E92 Series	07-14	Front	R	
70791	Gas Ryder	NEW	f 1.1	Kia	Picanto	Mk 2 (TA)	11 on	Front	L	
70792	Gas Ryder	NEW	f 1.1	Kia	Picanto	Mk 2 (TA)	11 on	Front	R	
70793	Gas Ryder	NEW	f 1.1	Hyundai	Elantra	HD Sedan	06-10	Front	L	
70794	Gas Ryder	NEW	f 1.1	Hyundai	Elantra	HD Sedan	06-10	Front	R	
70795	Gas Ryder	NEW	f 1.1	Kia	Cerato	Hatch & Sedan	09-13	Front	L	
70796	Gas Ryder	NEW	f 1.1	Kia	Cerato	Hatch & Sedan	09-13	Front	R	
70800	Gas Ryder	NEW	f 1.1	Chevrolet	Spark	M200, M250 Hatch	06-10	Front	L	
70801	Gas Ryder	NEW	f 1.1	Chevrolet	Spark	M200, M250 Hatch	06-10	Front	R	
70802	Gas Ryder	NEW	f 1.1	Toyota	Yaris	Hatch	11 on	Front	L	
70803	Gas Ryder	NEW	f 1.1	Toyota	Yaris	Hatch	11 on	Front	R	
70804	Gas Ryder	NEW	f 1.1	Hyundai	H1	Minibus	09 on	Front	L	
70805	Gas Ryder	NEW	f 1.1	Hyundai	H1	Minibus	09 on	Front	R	
70806	Gas Ryder	NEW	f 1.1	Nissan	Micra	Hatch	11 on	Front	L	
70807	Gas Ryder	NEW	f 1.1	Nissan	Micra	Hatch	11 on	Front	R	
70808	Gas Ryder	NEW	f 1.1	Mercedes-Benz	C Class	(CLC 203) Coupe	00-11	Front	↔	
70809	Gas Ryder	NEW	f 1.1	Renault	Clio	Clio II 1.6 16V Sport	00-06	Front	↔	
70810	Gas Ryder	NEW	f 1.1	Hyundai	Accent	Sedan	11-13	Front	L	
70811	Gas Ryder	NEW	f 1.1	Hyundai	Accent	Sedan	11-13	Front	R	
70814	Gas Ryder	NEW	f 1.1	BMW	5 Series	E60 Series Sedan	04-10	Front	L	
70815	Gas Ryder	NEW	f 1.1	BMW	5 Series	E60 Series Sedan	04-10	Front	R	
76003	Fleet Ryder	OBS.	† 5	Isuzu	TM, TX, TW Series	Truck	72 on	Front	↔	
				Isuzu	TXD 45	Truck	80-86	Front	↔	
				Kenworth	K374-29	Truck	19..	Front	↔	



Part #	Range	Superceding Part #/Status.	Product Type	Make	Model	Derivative	Year	Position	L/R	Note # (pg 6)
76006	Fleet Ryder		† 5	Bussing	19L, BBL	Truck	19..	Front	↔	
				ERF	E6 (Air Susp.)	Truck	19..	Front	↔	
				International	S2670-407T, S Series	Truck	80-85	Front	↔	
				Leyland	Buffalo	Truck	19..	Front	↔	
				Leyland	Eland	Bus	19..	Front	↔	
				Leyland	Pioneer Plus	Truck	19..	Front	↔	
				Leyland	Road Train	Truck	19..	Front	↔	
				Isuzu	BD	Bus	74 on	Rear	↔	
				Leyland	Eland	Bus	19..	Rear	↔	
				Leyland	Guy Victory J, Mk II	Bus	19..	Rear	↔	
				Leyland	Kudu 352 RA, A691	Bus	19..	Rear	↔	
				Scania	LB 81 HS-31/50 4X2	Truck	75-82	Rear	↔	
				Scania	LBT 111-HS31 6X4	Truck	75-82	Rear	↔	
				Scania	LBT 141 HS-31/46 6X4	Truck	78-82	Rear	↔	
Scania	P82ML 4X2(S) 4X2	Truck	82-89	Rear	↔					
76007	Fleet Ryder		∞ 8.2	DAF	AT1900	Truck	19..	Front	↔	
				Isuzu	SFR, TD	Truck	72 on	Front	↔	31
				DAF	AT1900	Truck	19..	Rear	↔	
				Ford	D1210, D1211	Truck	78-82	Rear	↔	
				Ford	D1311, D1414	Truck	72-82	Rear	↔	
				Ford	DA 2114	Truck	74-82	Rear	↔	
				Ford	DO 607, DO 807	Truck	73-82	Rear	↔	
				Ford	DO 910, D1010	Truck	71-82	Rear	↔	
76008	Fleet Ryder		∞ 8.2	International	E-Line	Truck	19..	Front	↔	
				Volvo	F12, FL12, FH12	Truck	19..	Front	↔	
76009 (Cont. on next page)	Fleet Ryder		† 5	Bedford	VAM	Bus	76 on	Front	↔	
				Ford	D1210, D1211	Truck	78-82	Front	↔	
				Ford	D1311, D1414	Truck	72-82	Front	↔	
				Ford	DA 2114	Truck	74-82	Front	↔	
				Ford	DO 607, DO 807	Truck	73-82	Front	↔	
				Ford	DO 910, D1010	Truck	71-82	Front	↔	
				Ford	DT 2014	Truck	72-82	Front	↔	
				International	4700, 4900(4X2), 4900 (6x4)	Truck	93 on	Front	↔	
				Leyland	AEC Mk IV	Bus	19..	Front	↔	
				Leyland	Clydesdale CD23	Bus	19..	Front	↔	
				Leyland	Eland EL 4114, 14.12	Truck	73-85	Front	↔	
Leyland	Mammoth Major, Mandator	Truck	19..	Front	↔					
Leyland	Monarch, 2TG4RE	Truck	19..	Front	↔					

PARTS LISTING

Shocks & Struts

76009



Part #	Range	Superceding Part #/Status.	Product Type	Make	Model	Derivative	Year	Position	L/R	Note # (pg 6)
76009 <small>(From previous page)</small>	Fleet Ryder		† 5	Leyland	Worldmaster	Bus	19..	Front	↔	
				Mercedes-Benz	0.317	Bus	19..	Front	↔	
				Mercedes-Benz	0.302, 0.305 (Air Susp.)	Bus	19..	Front	↔	
				Leyland	Tiger	Bus	19..	Rear	↔	
				Mercedes-Benz	0.302, 0.305 (Air Susp.)	Bus	19..	Rear	↔	
76014	Fleet Ryder		⊗ 8.5	Mack	786FS	Truck	19..	Front	↔	
				Unimog	Buffel	414, 416 Truck	19..	Front	↔	
				Unimog	Buffel	414, 416 Truck	19..	Rear	↔	
76015	Fleet Ryder		⊗ 8.2	Bedford	4X4	Truck	70-80	Front	↔	
				Bedford	ELR4, ELR 6, ELR A, ELR 8	Truck	75-79	Front	↔	
				Bedford	KE, KG, KH All	Truck	64 on	Front	↔	
				Bedford	MFR	Truck	67-71	Front	↔	
				Bedford	VAL	Bus	66 on	Front	↔	
				International	Fleetstar	Truck	19..	Front	↔	
				International	Loadstar 1850	Truck	71-78	Front	↔	
				Peterbilt	320	Truck	95 on	Front	↔	
				Peterbilt	377A/E	Truck	95 on	Front	↔	
				Bedford	4X4	Truck	70-80	Rear	↔	
				Bedford	KE, KG, KH All	Truck	64 on	Rear	↔	
				Bedford	MFR	Truck	67-71	Rear	↔	
				Isuzu	N2800 P	Truck	93 on	Rear	↔	29
				Isuzu	N3000 P	Truck	87-90	Rear	↔	29
				Isuzu	NKR55/99	Truck	19..	Rear	↔	29
Isuzu	TL40-50	Truck	75 on	Rear	↔	29				
Isuzu	TLD44, TLD54	Truck	77-89	Rear	↔	29				
76016	Fleet Ryder		⊖ 6.1	Isuzu	CVR, EXR, FT	Truck	89 on	Front	↔	
				Isuzu	F8000 (TN), F9000 (TT)	Truck	88 on	Front	↔	
				Isuzu	FSR700	Truck	96 on	Front	↔	
				Isuzu	SPZ, SHZ, SPR, SHR	Truck	80 on	Front	↔	
				Leyland	Marathon	Truck	76-83	Front	↔	
				Nissan	CM 12/CM14	Truck	87 on	Front	↔	
				Nissan	CM 16 N	Truck	90 on	Front	↔	
				Scania	80, 110	Truck	19..	Front	↔	
				Scania	LB 81 HS-31/50 4X2	Truck	75-82	Front	↔	
				Scania	LBT 111-HS31 6X4	Truck	75-82	Front	↔	
Scania	LBT 141 HS-31/46 6X4	Truck	78-82	Front	↔					
Toyota	DA 110, 116	Truck	73 on	Front	↔					

76009 - 76016



Part #	Range	Superceding Part # /Status.	Product Type	Make	Model	Derivative	Year	Position	L/R	Note # (pg 6)	
76017	Fleet Ryder		8.2	%	Western Star	3842S	Truck	19..	Front	↔	26
					Western Star	4842S, 4864S	Truck	19..	Front	↔	26
					Western Star	5964F, 5964F	Truck	19..	Front	↔	26
					Fiat	130NR	Truck	77-83	Front	↔	
					Fiat	682 SWB	Truck	19..	Front	↔	
					Fiat	684N, 684T	Truck	71-81	Front	↔	
					Oshkosh	E - 1344 T 290	Truck	78-83	Front	↔	
					Oshkosh	E - 1446 T 350	Truck	80-83	Front	↔	
76019	Fleet Ryder		8.5	%	Man	16, 281	Bus	19..	Front	↔	
					Mercedes-Benz	1113B, L, LK	Truck	68-94	Front	↔	
					Mercedes-Benz	1113B, LS	Truck	68-94	Front	↔	
					Mercedes-Benz	1313, L, LK	Truck	72-76	Front	↔	
					Mercedes-Benz	1313LS	Truck	19..	Front	↔	
					Mercedes-Benz	1317L, LK	Truck	19..	Front	↔	
					Mercedes-Benz	1513, 1517LS	Truck	19..	Front	↔	
					Mercedes-Benz	1513L, LK	Truck	70-75	Front	↔	
					Mercedes-Benz	1517, 1519, L, LK	Truck	75-80	Front	↔	
					Mercedes-Benz	1621, L, LK, LS	Truck	77-79	Front	↔	
					Mercedes-Benz	1624, L, LK, LAK, LS, LAS	Truck	19..	Front	↔	
					Mercedes-Benz	1921, L, LK, LS	Truck	70-77	Front	↔	
					Mercedes-Benz	1924, L, LK, LA, LAK, LS, LAS	Truck	19..	Front	↔	
					Mercedes-Benz	911B, L, LK	Truck	19..	Front	↔	
					Mercedes-Benz	911B, LS	Truck	19..	Front	↔	
					Bussing	14, 15 AK	Truck	19..	Rear	↔	
Mercedes-Benz	Powerliner 1729S/32	Truck	94 on	Rear	↔						
Mercedes-Benz	Powerliner 1735S/35	Truck	92 on	Rear	↔						
76020	Fleet Ryder		5	+	Leyland	Crusader	Truck	19..	Front	↔	
					Leyland	Guy Victory J, Mk II	Bus	19..	Front	↔	
					Leyland	Tiger	Bus	19..	Front	↔	
					DAF	FTT 2800 DKTD	Truck	75-82	Rear	↔	
					Leyland	Leopard	Truck	19..	Rear	↔	
					Man	16, 201	Truck	19..	Rear	↔	
					Man	16.220	Bus	19..	Rear	↔	
					Mercedes-Benz	O, 317	Bus	19..	Rear	↔	
					Mercedes-Benz	OH 1725L/59	Bus	19..	Rear	↔	
					Mercedes-Benz	OH 1835L/30	Bus	19..	Rear	↔	
Scania	Bus	Bus	19..	Rear	↔						

PARTS LISTING

Shocks & Struts

76021



Part #	Range	Superceding Part #/Status.	Product Type	Make	Model	Derivative	Year	Position	L/R	Note # (pg 6)
76021	Fleet Ryder		8.5	Man	16, 201	Truck	19..	Front	↔	
				Man	16.220	Bus	19..	Front	↔	
				Man	30.280 DHT	Truck	78-84	Front	↔	
				Mercedes-Benz	1418, L, LK	Truck	68-79	Front	↔	
				Mercedes-Benz	1618, L, LK	Truck	19..	Front	↔	
				Mercedes-Benz	1620, L, LK	Truck	19..	Front	↔	
				Mercedes-Benz	1623, L, LK, LAK	Truck	19..	Front	↔	
				Mercedes-Benz	1918, 1920, L, LK	Truck	19..	Front	↔	
				Mercedes-Benz	1923L, LK	Truck	19..	Front	↔	
				Mercedes-Benz	2220, L, LA, LS, LAS	Truck	19..	Front	↔	
				Mercedes-Benz	2620, L, LA, LS, LAS	Truck	19..	Front	↔	
				Mercedes-Benz	2623, L, LS, LK, LA, LAS, LAK	Truck	19..	Front	↔	
				Mercedes-Benz	2629, LA, LAK, LAS	Truck	19..	Front	↔	
				Mercedes-Benz	1113, L, LK, LF, LP, LPK	Truck	68-94	Rear	↔	30
76022	Fleet Ryder		8.5	Mercedes-Benz	1313, L, LK	Truck	72-76	Rear	↔	
				Mercedes-Benz	1317L, LK	Truck	19..	Rear	↔	
				Mercedes-Benz	1317LP, LPK	Truck	19..	Rear	↔	
				Mercedes-Benz	1319LP, LPK	Truck	19..	Rear	↔	
				Mercedes-Benz	1413L, LK, LS	Truck	76-82	Rear	↔	
				Mercedes-Benz	1513, 1517LP, LPK	Truck	19..	Rear	↔	
				Mercedes-Benz	1513L, LK	Truck	70-75	Rear	↔	
				Mercedes-Benz	1517, 1519, L, LK	Truck	75-80	Rear	↔	
				Mercedes-Benz	1517, 1519, LAS	Truck	19..	Rear	↔	
				Mercedes-Benz	1617, LP, LPK	Truck	19..	Rear	↔	
				Mercedes-Benz	1619, LP	Truck	19..	Rear	↔	
				Mercedes-Benz	352 F	Bus	19..	Rear	↔	
				Mercedes-Benz	OF 1113, 1313, 1317/51, 1413, 1417/52, 1617	Bus	19..	Rear	↔	
				76033 (Cont. on next page)	Fleet Ryder		8.5	Bussing	16L, LBL, LU, UK	Truck
Man	30.330 DFT/DFTS/DFL	Truck	84-89					Front	↔	
Mercedes-Benz	1735	Truck	19..					Front	↔	
Mercedes-Benz	1113B, LA, LAK	Truck	73-83					Front	↔	
Mercedes-Benz	1113B, LAS	Truck	73-83					Front	↔	
Mercedes-Benz	1213, 1213K, 1217, 1217K	Truck	79-94					Front	↔	
Mercedes-Benz	1313, LAK, LAS, LA	Truck	19..					Front	↔	
Mercedes-Benz	1413L, 1413K, 1417, 1417K	Truck	82-93					Front	↔	
Mercedes-Benz	1419, 1419K, 1419S	Truck	77-88					Front	↔	
Mercedes-Benz	1513LA, LAK	Truck	19..					Front	↔	
Mercedes-Benz	1517, 1519, LA, LAK	Truck	76-94					Front	↔	
Mercedes-Benz	1517, 1519, LAS	Truck	19..	Front	↔					

76021 - 76033





76033
(From previous page)

Fleet Ryder

8.5

Part #	Range	Superceding Part # /Status.	Product Type	Make	Model	Derivative	Year	Position	L/R	Note # (pg 6)
				Mercedes-Benz	1617, LP, LPK	Truck	19..	Front	↔	
				Mercedes-Benz	1619, LP	Truck	19..	Front	↔	
				Mercedes-Benz	1813L	Truck	19..	Front	↔	
				Mercedes-Benz	1817, 1819, L	Truck	19..	Front	↔	
				Mercedes-Benz	1926S, 1928, 1928S, 1933S	Truck	81-92	Front	↔	
				Mercedes-Benz	2017, 2019, L, LB	Truck	19..	Front	↔	
				Mercedes-Benz	2233S	Truck	82-86	Front	↔	
				Mercedes-Benz	2624, A, AK, K, S	Truck	81-88	Front	↔	
				Mercedes-Benz	2624, L, LS, LK, LAK, LAS, LB, LAB	Truck	70-81	Front	↔	
				Mercedes-Benz	2628K, A, S	Truck	81-93	Front	↔	
				Mercedes-Benz	2632, L, K, AK, S, AS	Truck	75-83	Front	↔	
				Mercedes-Benz	2633S, 2636S, 2638S	Truck	83-93	Front	↔	
				Mercedes-Benz	2644S/32	Truck	94 on	Front	↔	
				Mercedes-Benz	3328S, 3333S	Truck	87-92	Front	↔	
				Mercedes-Benz	911B, LA, LAK	Truck	19..	Front	↔	
				Mercedes-Benz	911B, LAS	Truck	19..	Front	↔	
				Mercedes-Benz	Actros 1831LS/36, 1835/36	Truck	19..	Front	↔	
				Mercedes-Benz	Actros 2031 S/36	Truck	99 on	Front	↔	
				Mercedes-Benz	Actros 2643 LS/33, 2649LS/32	Truck	99 on	Front	↔	
				Mercedes-Benz	Actros 3335S/33	Truck	99 on	Front	↔	
				Mercedes-Benz	Actros 3343 S/33	Truck	99 on	Front	↔	
				Mercedes-Benz	Atego 1017/48, 48AK, /36	Truck	19..	Front	↔	
				Mercedes-Benz	Econoliner 1014/48, 1214/48	Truck	95 on	Front	↔	
				Mercedes-Benz	Econoliner 1414K/36, 1414/48	Truck	92 on	Front	↔	
				Mercedes-Benz	Econoliner 1617/48 & 52	Truck	94 on	Front	↔	
				Mercedes-Benz	Econoliner 1617A/36, 1617K/36	Truck	92 on	Front	↔	
				Mercedes-Benz	Econoliner 1623S/36	Truck	96 on	Front	↔	
				Mercedes-Benz	L1013, 1013K, 1014	Truck	81-87	Front	↔	
				Mercedes-Benz	LA1213B	Truck	79-89	Front	↔	
				Mercedes-Benz	OH 1725L/59	Bus	19..	Front	↔	
				Mercedes-Benz	OH 1835L/30	Bus	19..	Front	↔	
				Mercedes-Benz	Powerliner 1729S/32	Truck	94 on	Front	↔	
				Mercedes-Benz	Powerliner 1735S/35	Truck	92 on	Front	↔	
				Mercedes-Benz	Powerliner 2426B/32 & 52	Truck	92 on	Front	↔	
				Mercedes-Benz	Powerliner 2535S/32	Truck	94 on	Front	↔	
				Mercedes-Benz	Powerliner 2545S/32	Truck	96 on	Front	↔	
				Mercedes-Benz	Powerliner 2629K/32, 2629S/32, 2629/45	Truck	92 on	Front	↔	

PARTS LISTING

Shocks & Struts

76033



Part #	Range	Superceding Part #/Status.	Product Type	Make	Model	Derivative	Year	Position	L/R	Note # (pg 6)
76033 <small>(From previous page)</small>	Fleet Ryder		⊗ 8.5	Mercedes-Benz	Powerliner 2635S/32, 2635/45	Truck	92 on	Front	↔	
				Mercedes-Benz	Powerliner 2638S/32	Truck	95 on	Front	↔	
				Mercedes-Benz	Powerliner 3836K/38	Truck	19..	Front	↔	
				Mercedes-Benz	1735	Truck	19..	Rear	↔	
				Mercedes-Benz	1926S, 1928, 1928S, 1933S	Truck	81-92	Rear	↔	
76034	Fleet Ryder		⊕ 5	Ford	Cargo 0608, 0808	Truck	82-86	Front	↔	
				Ford	Cargo 0912, 1112, 1113	Truck	82-86	Front	↔	
				Ford	Cargo 1212, 1213	Truck	82-85	Front	↔	
				Ford	Cargo 1312, 1313	Truck	82-86	Front	↔	
				Ford	Cargo 1317, 1517	Truck	82-86	Front	↔	
				Ford	Cargo 2217	Truck	82-86	Front	↔	
				Bussing	22L, BLL (Tag axle)	Truck	19..	Rear	↔	
				DAF	FA2200, F2200	Truck	72-80	Rear	↔	
				Scania	P112H (6X2)	Truck	82-89	Rear	↔	
				Scania	P142H (6X2)	Truck	82-89	Rear	↔	
				Scania	R112HL 6X4(S)	Truck	82-89	Rear	↔	
				Scania	R142H (6X4)	Truck	82-89	Rear	↔	
76035	Fleet Ryder		⊖ 6.1	DAF	FA2200, F2200	Truck	72-80	Front	↔	
				DAF	FTT 2800 DKTD	Truck	75-82	Front	↔	
				ERF	ERF	Truck	19..	Front	↔	
				Scania	112, 142	Truck	19..	Front	↔	
				Scania	K94	Bus	19..	Front	↔	
				Scania	P112H (6X2)	Truck	82-89	Front	↔	
				Scania	P114GA 6x4 NZ 380	Truck	19..	Front	↔	
				Scania	P124 CB 6x4 NZ 470	Truck	19..	Front	↔	
				Scania	P124GA 400	Truck	19..	Front	↔	
				Scania	P124GA 6x4 NZ 420, 470	Truck	19..	Front	↔	
				Scania	P124LA 6x2 NA 420	Truck	19..	Front	↔	
				Scania	P142H (6X2)	Truck	82-89	Front	↔	
				Scania	P82ML 4X2(S) 4X2	Truck	82-89	Front	↔	
				Scania	P94LA 4X2 NA 310	Truck	19..	Front	↔	
				Scania	R112HL 6X4(S)	Truck	82-89	Front	↔	
				Scania	R142H (6X4)	Truck	82-89	Front	↔	
				76036	Fleet Ryder		⊗ 8.5	Mercedes-Benz	352 F	Bus
Mercedes-Benz	OF 1113, 1313, 1317/51, 1413, 1417/52, 1617	Bus	19..					Front	↔	

76033 - 76036





Part #	Range	Superceding Part # /Status.	Product Type	Make	Model	Derivative	Year	Position	L/R	Note # (pg 6)
76037	Fleet Ryder	OBS.	⊖ 6.2	Mercedes-Benz	608 LP, LPK, LPS, LPO	Truck	19..	Front	↔	
				Mercedes-Benz	609, 811 LP, LPS, LPK	Truck	19..	Front	↔	
				Mercedes-Benz	808 LP, LPS, LPK	Truck	19..	Front	↔	
				Mercedes-Benz	913, LP, LPK, LPS	Truck	19..	Front	↔	
76038	Fleet Ryder	OBS.	⊖ 8.5	Mercedes-Benz	1413L, LK, LS	Truck	76-82	Front	↔	
76039	Fleet Ryder		⊖ 8.5	Mercedes-Benz	1113, L, LK, LF, LP, LPK	Truck	68-94	Front	↔	30
				Mercedes-Benz	1418, LP, LPS	Truck	19..	Front	↔	
76040	Fleet Ryder		⊖ 8.5	Mack	R600RST, F700RST Series	Truck	73-85	Front	↔	
76041	Fleet Ryder		⊕ 5	Leyland	Guy Victory J, MK1	Bus	19..	Front	↔	
				Leyland	Kudu 352 RA, A691	Bus	19..	Front	↔	
				Leyland	Leopard	Truck	19..	Front	↔	
				Leyland	Super Comet	Truck	19..	Front	↔	
				Leyland	Super Eland 22.12, 24.12	Truck	75-85	Front	↔	
				Nissan	CM 90	Truck (Condor)	19..	Front	↔	
76042 (Cont. on next page)	Fleet Ryder		⊖ 8.2	Bedford	KM All	Truck	72 on	Front	↔	
				Hino	55/330, 55/350	Truck	85-94	Front	↔	
				Hino	C40	Truck	93 on	Front	↔	
				Hino	FF13-133, FF14-173	Truck	83-94	Front	↔	
				Hino	GD, Super Dolphin	Truck	19..	Front	↔	
				Hino	KB 302, 342, 14-177	Truck	72-84	Front	↔	
				International	ACCO 1600, 1830C	Truck	84-85	Front	↔	
				International	ACCO 1840D MK11	Truck	79-83	Front	↔	
				International	Paystar F5070/350	Truck	73-84	Front	↔	
				International	Transtar COF-4070	Truck	75-79	Front	↔	
				International	Unistar R91	Truck	19..	Front	↔	
				Isuzu	BD	Bus	74 on	Front	↔	
				Isuzu	SLR, VPR	Truck	72 on	Front	↔	
				Isuzu	SPZ	Truck	73-80	Front	↔	
				Leyland	AEC Mk IV (with Air cushions)	Bus	19..	Front	↔	
				Leyland	AEC Mk IV (without Air cushions)	Bus	19..	Front	↔	
				Leyland	Chieftain CH 4013, 14.10	Truck	79-86	Front	↔	
				Leyland	Mastiff	Truck	19..	Front	↔	
				Oshkosh	R Series	Truck	19..	Front	↔	
				Volvo	B7F	Bus	19..	Front	↔	
Volvo	F88, G88	Truck	19..	Front	↔					
Western Star	3842S	Truck	19..	Front	↔	26				
Western Star	4842S, 4864S	Truck	19..	Front	↔	26				
Western Star	5964F, 5964F	Truck	19..	Front	↔	26				

PARTS LISTING

Shocks & Struts

76042



Part #	Range	Superceding Part #/Status.	Product Type	Make	Model	Derivative	Year	Position	L/R	Note # (pg 6)
76042 (From previous page)	Fleet Ryder		8.2	Ford	Cargo 0608, 0808	Truck	82-86	Rear	↔	
				Ford	Cargo 0912, 1112, 1113	Truck	82-86	Rear	↔	
				Ford	Cargo 1212, 1213	Truck	82-85	Rear	↔	
				Ford	Cargo 1312, 1313	Truck	82-86	Rear	↔	
				Ford	Cargo 1317, 1517	Truck	82-86	Rear	↔	
				Ford	Cargo 2217	Truck	82-86	Rear	↔	
				International	Unistar R91	Truck	19..	Rear	↔	
				Leyland	AEC Mk IV (with Air cushions)	Bus	19..	Rear	↔	
				Leyland	Eland EL 4114, 14.12	Truck	73-85	Rear	↔	
				Leyland	Guy Victory J, MK1	Bus	19..	Rear	↔	
				Silver Eagle	SAR Coach	Bus	19..	Rear	↔	
76043	Fleet Ryder		6.1	Isuzu	FTR800	Truck	96 on	Front	↔	
				Isuzu	FVZ1400	Truck	94 on	Front	↔	
				Leyland	Swift	Bus	19..	Front	↔	
				Toyota	DA/ KA	Truck	00 on	Front	↔	
				Isuzu	SBR 422, FJR	Truck	76-83	Rear	↔	
76100	Fleet Ryder	OBS.	8.2	Ford	Louisville Line LNT 9000	Truck	76-83	Front	↔	
76102	Fleet Ryder		6.1	Hino	FE	Truck	83 on	Front	↔	
				Hino	KR 320, 360	Truck	74-84	Front	↔	
				Isuzu	CVR, 49N	Truck	79-89	Front	↔	
				Isuzu	F5000 (FN), F6599 (FN)	Truck	88 on	Front	↔	
				Nissan	UG 80	Bus	19..	Front	↔	
				Nissan	UG780, UD780	Truck	69 on	Front	↔	
76103 (Cont. on next page)	Fleet Ryder		6.1	Bedford	YRT	Bus	19..	Front	↔	
				ERF	Trailblazer	Truck	19..	Front	↔	32
				Isuzu	FVR2200 Turbo	Truck	93 on	Front	↔	
				Isuzu	FVR900 Turbo	Truck	93 on	Front	↔	
				Man	M2000 15.223L, 16.223L, K, LA	Truck	19..	Front	↔	
				Nissan	CB 20	Bus	19..	Front	↔	
				Nissan	CK10 K/A	Truck	74-86	Front	↔	
				Nissan	CK20 D/L/N	Truck	73-83	Front	↔	
				Nissan	CK25D/N	Truck	83-84	Front	↔	
				Nissan	CK41 CT	Truck	80-85	Front	↔	
				Nissan	CM 15 E	Truck	87-92	Front	↔	
				Nissan	CW 350 HTA, HTF	Truck	93 on	Front	↔	
				Nissan	CW290 HDN, PHN	Truck	93 on	Front	↔	
Nissan	CW290 PPA, HTA, HTF, CK290 CTA	Truck	93-95	Front	↔					
Nissan	CW41 H/P	Truck	77-85	Front	↔					

76042 - 76103



Part #	Range	Superceding Part #/Status.	Product Type	Make	Model	Derivative	Year	Position	L/R	Note # (pg 6)
76103 (From previous page)	Fleet Ryder		⊥ 6.1	Nissan	CW45 HD/PA	Truck	82-89	Front	↔	
				Nissan	CW46 HDN, HTF, HMF, HTA, PAN	Truck	89-93	Front	↔	
				Nissan	CW46 PAF, PAA	Truck	89-92	Front	↔	
				Nissan	CW47 HDN, HTA, HTF, PAF, PAN	Truck	93-95	Front	↔	
				Nissan	CW55 HTF, CW56 HTF	Truck	89-95	Front	↔	
				ERF	Trailblazer	Truck	19..	Rear	↔	32
				Leyland	Marathon	Truck	76-83	Rear	↔	
76104	Fleet Ryder		⊙ 8.5	Mercedes-Benz	1113B, LAS	Truck	73-83	Rear	↔	
				Mercedes-Benz	1113B, LS	Truck	68-94	Rear	↔	
				Mercedes-Benz	1313, LAK, LAS, LA	Truck	19..	Rear	↔	
				Mercedes-Benz	1313LS	Truck	19..	Rear	↔	
				Mercedes-Benz	1513, 1517LS	Truck	19..	Rear	↔	
				Mercedes-Benz	1513LA, LAK	Truck	19..	Rear	↔	
				Mercedes-Benz	1517, 1519, LA, LAK	Truck	76-94	Rear	↔	
				Mercedes-Benz	911B, LAS	Truck	19..	Rear	↔	
				Mercedes-Benz	911B, LS	Truck	19..	Rear	↔	
				Mercedes-Benz	LA1213B	Truck	79-89	Rear	↔	
				Mercedes-Benz	OF 1621, 1624	Bus	86 on	Rear	↔	
76106	Fleet Ryder		⊙ 8.5	Mercedes-Benz	1213AK	Truck	79-94	Front	↔	
				Mercedes-Benz	2219, 2219K, 2224	Truck	82-93	Front	↔	
				Mercedes-Benz	2224B, 2225B	Truck	86-93	Front	↔	
76108	Fleet Ryder		⊥ 6.1	Isuzu	JCR 500	Truck	19..	Front	↔	
				Isuzu	N 3500 D, N4000 D	Truck	86 on	Front	↔	
				Isuzu	NPR 300, 400	Truck	86 on	Front	↔	
76109	Fleet Ryder		⊙ 8.5	Mercedes-Benz	OF 1621, 1624	Bus	86 on	Front	↔	
76110	Fleet Ryder		⊙ 8.2	Isuzu	N 3500 D, N4000 D	Truck	86 on	Rear	↔	
				Isuzu	NPR 300, 400	Truck	86 on	Rear	↔	
76131 (Cont. on next page)	Fleet Ryder		⊥ 6.2	Man	27, 463	Truck	19..	Front	↔	
				Man	19.292 FT/FTS	Truck	90-94	Front	↔	
				Man	19.300FT, 19.320, 19.321 FT/FTS	Truck	85-90	Front	↔	
				Man	19.362 FTS	Truck	89-93	Front	↔	
				Man	26.292 DFT/DFTS/DFL/DFK	Truck	89 on	Front	↔	
				Man	26.362 DFTS/DFLS	Truck	90 on	Front	↔	
				Man	26.372 DFT/DFTS	Truck	90-95	Front	↔	
				Man	26.402 DFTS, 422	Truck	93 on	Front	↔	
				Man	26.442, 26.552 DFTS	Truck	90 on	Front	↔	
				Man	29.292 DFT/DFTS/DFL/DFK	Truck	89-92	Front	↔	
				Man	30.365 DFT/DFTS/DFL	Truck	86-89	Front	↔	
				Man	30.380 DFT/DFTS/DFL	Truck	84-89	Front	↔	

PARTS LISTING

Shocks & Struts

76131



Part #	Range	Superceding Part #/Status.	Product Type	Make	Model	Derivative	Year	Position	L/R	Note # (pg 6)	
76131 <small>(From previous page)</small>	Fleet Ryder		1/6	6.2	Man	30.440 DFTS/DFL	Truck	87-90	Front	↔	
					Man	F2000 27.463TS, 27.464 TS	Truck	19..	Front	↔	
					Man	F2000 33.373KN, TN	Truck	19..	Front	↔	
					Man	F2000 33.374K, L, T	Truck	19..	Front	↔	
					Man	F2000 33.423TS	Truck	19..	Front	↔	
					Man	F2000 40.464 TS	Truck	19..	Front	↔	
76132	Fleet Ryder		1/6	6.1	Hino	FD 10-135	Truck	83-94	Front	↔	
					Hino	KL 340, KL360	Truck	72-83	Front	↔	
					Isuzu	NKR	Truck	96 on	Front	↔	
					Isuzu	SBR 422, FJR	Truck	76-83	Front	↔	
76135	Fleet Ryder	OBS.	∞	8.2	Isuzu	NPR 66	Truck	19..	Rear	↔	
76150	Fleet Ryder	OBS.	∞	8.5	International	9800 Eagle	Truck (Set forward axle)	19..	Front	↔	
76151	Fleet Ryder		1/6	6.2	International	9800 Eagle	Truck (Set back axle)	19..	Front	↔	
76156	Fleet Ryder		1/6	6.2	Iveco	Eurotech	MPL440E42T, 440E 34, 38, 42, 52	92 on	Front	↔	
76157	Fleet Ryder		∞	8.5	Iveco	Eurotech	MPL440E42T, 440E 34, 38, 42, 52	92 on	Rear	↔	
76185	Fleet Ryder		∞	8.5	Tata	LPT 1518TC	Truck	05 on	Front	↔	
76186	Fleet Ryder		∞	8.5	Tata	LPT 1518TC	Truck	05 on	Rear	↔	
76204	Fleet Ryder		1/6	6.1	Isuzu	FTR800 4X2 FC	Truck	97 on	Front	↔	
76205	Fleet Ryder		1/6	6.1	Nissan	UD 80 4X2 F-C	Truck	97 on	Front	↔	
76206	Fleet Ryder		†	5	Nissan	UD 80 4X2 F-C	Truck	97 on	Rear	↔	
76207	Fleet Ryder		∞	8.2	Hino	500	1626 Series	97 on	Front	↔	
76208	Fleet Ryder		∞	8.5	Iveco	Daily	Panel van 107Kw D (50C15, 65C15, 70C15)	04 on	Front	↔	
					Iveco	Daily	Panel van 92Kw D (35S13, 50C13)	01-08	Front	↔	
76209	Fleet Ryder		∞	8.5	Iveco	Daily	Panel van 107Kw D (50C15, 65C15, 70C15)	04 on	Rear	↔	
					Iveco	Daily	Panel van 92Kw D (35S13, 50C13)	01-08	Rear	↔	
77000	Fleet Ryder		†	5	Neoplan	Cityliner	Bus	19..	Front	↔	
					Neoplan	Cityliner	Bus	19..	Rear	↔	
77001	Fleet Ryder		1/6	6.2	Mercedes-Benz	1213, 1213K, 1217, 1217K	Truck	79-94	Rear	↔	
					Mercedes-Benz	1213AK	Truck	79-94	Rear	↔	
					Mercedes-Benz	1413L, 1413K, 1417, 1417K	Truck	82-93	Rear	↔	
					Mercedes-Benz	1419, 1419K, 1419S	Truck	77-88	Rear	↔	
					Mercedes-Benz	Econoliner 1617/48 & 52	Truck	94 on	Rear	↔	
					Mercedes-Benz	Econoliner 1617A/36, 1617K/36	Truck	92 on	Rear	↔	
					Mercedes-Benz	L1013, 1013K, 1014	Truck	81-87	Rear	↔	
77002	Fleet Ryder		∞	8.2	Silver Eagle	SAR Coach	Bus	19..	Front	↔	
77003	Fleet Ryder		∞	8.5	Man	16.240 FT/FTS/HT/HL/ HAL/HAK	Truck	76-89	Front	↔	
					Man	19.280 FT/FTS	Truck	78-90	Front	↔	
					Man	22/24.192 DHK, DHL	Truck	76-87	Front	↔	
					Man	M2000 14.153 L	Truck	19..	Front	↔	

76131 - 77003



77004

PARTS LISTING

Shocks & Struts

77004 - 77022

Part #	Range	Superceding Part #/Status.	Product Type	Make	Model	Derivative	Year	Position	L/R	Note # (pg 6)	
77004	Fleet Ryder		† 5	DAF	FT 2200 DU	Truck	72-80	Front	↔		
77005	Fleet Ryder		⊕ 8.5	Magnis	Msiza	Truck	19..	Front	↔		
77006	Fleet Ryder		† 5	Renault	CBH 385	Truck	96 on	Front	↔		
77007	Fleet Ryder		⊕ 8.5		Mercedes-Benz	1113B, LA, LAK	Truck	73-83	Front	↔	
					Mercedes-Benz	1113B, LAS	Truck	73-83	Front	↔	
					Mercedes-Benz	1313, LAK, LAS, LA	Truck	19..	Front	↔	
					Mercedes-Benz	1413L, 1413K, 1417, 1417K	Truck	82-93	Front	↔	
					Mercedes-Benz	1419, 1419K, 1419S	Truck	77-88	Front	↔	
					Mercedes-Benz	1513LA, LAK	Truck	19..	Front	↔	
					Mercedes-Benz	1517, 1519, LA, LAK	Truck	76-94	Front	↔	
					Mercedes-Benz	1517, 1519, LAS	Truck	19..	Front	↔	
					Mercedes-Benz	1813L	Truck	19..	Front	↔	
					Mercedes-Benz	1817, 1819, L	Truck	19..	Front	↔	
					Mercedes-Benz	1926S, 1928, 1928S, 1933S	Truck	81-92	Front	↔	
					Mercedes-Benz	2017, 2019, L, LB	Truck	19..	Front	↔	
					Mercedes-Benz	2624, A, AK, K, S	Truck	81-88	Front	↔	
					Mercedes-Benz	2628K, A, S	Truck	81-93	Front	↔	
					Mercedes-Benz	2632, L, K, AK, S, AS	Truck	75-83	Front	↔	
					Mercedes-Benz	2633S, 2636S, 2638S	Truck	83-93	Front	↔	
					Mercedes-Benz	3328S, 3333S	Truck	87-92	Front	↔	
Mercedes-Benz	911B, LA, LAK	Truck	19..	Front	↔						
Mercedes-Benz	911B, LAS	Truck	19..	Front	↔						
Mercedes-Benz	LA1213B	Truck	79-89	Front	↔						
77008	Fleet Ryder		⊕ 8.5	Caspir	Caspir	Truck	19..	Rear	↔		
77009	Fleet Ryder	OBS.	⊕ 10		Man	16, 281	Bus	19..	Rear	↔	
					Man	16.286, 16.320, 16.361 UL (Trailing Axle)	Truck	19..	Rear	↔	
					Man	22.280, 22.320, 23.321 (Trailing Axle)	Truck	19..	Rear	↔	
					Man	M2000 15.223L, 16.223L, K, LA	Truck	19..	Rear	↔	
77010	Fleet Ryder	OBS.	⊕ 8.5		Man	30.240 DFK	Truck	85-90	Front	↔	
					Man	30.240 DHAK	Truck	76-89	Front	↔	
					Man	30.300, 30.321 DFT/K/L	Truck	85-90	Front	↔	
77011	Fleet Ryder	OBS.	⊕ 6.1	ERF	Trailblazer	Truck	19..	Front	↔		
77012	Fleet Ryder	OBS.	† 5	International	4700, 4900(4X2), 4900 (6x4)	Truck	93 on	Front			
77018	Fleet Ryder		⊕ 8.5		Peterbilt	362 E 436, 460, 550	Truck	95 on	Front	↔	
					International	9800 Eagle	Truck (Set back axle)	19..	Rear	↔	27
					International	9800 Eagle	Truck (Set forward axle)	19..	Rear	↔	27
77022	Fleet Ryder		⊕ 8.5		Fiat	619T1	Truck	69-80	Front	↔	
					Freightliner	FL50, FL60, FL70, FL80	Truck	19..	Front	↔	

PARTS LISTING

Shocks & Struts

77023



Part #	Range	Superceding Part #/Status.	Product Type	Make	Model	Derivative	Year	Position	L/R	Note # (pg 6)	
77023	Fleet Ryder	OBS.	⊖	10	Man	16.286, 16.320, 16.361 UL (Trailing Axle)	Truck	19..	Front	↔	
					Man	19.291, 19.321 UL, 19.331, 19.361	Truck	19..	Front	↔	
					Man	22.280, 22.320, 23.321 (Trailing Axle)	Truck	19..	Front	↔	
77024	Fleet Ryder		†	5	Train Shock	-	-	-			
81270	Heavy Dutry	G56119	†	5	Nissan	Patrol	4X4 (G160)	80-89	Front	↔	
					Nissan	Patrol	4X4 (WG60)	72-80	Front	↔	
					Volvo	122	Amazon, B18	59-71	Rear		
					Nissan	Patrol	4X4 (WG60)	72-80	Rear	↔	
81297	Heavy Dutry	OBS.	⊖	6.2	Chevrolet / Opel	Ascona, Chevaire	B, (Mk I Cavalier)	76-82	Front	↔	
81469	Heavy Dutry	OBS.	⊗	8.2	Chrysler	Valiant	Incl. Dodge SE, Chrysler L	60-81	Rear	↔	
81514	Heavy Dutry	OBS.	⊖	13.1	Chevrolet	Chevelle	Mk I	64-70	Rear	↔	
82126	Heavy Dutry	OBS.	⊖	7.2	Ford	Laser, Meteor, Tracer	Familia	69-76	Front	↔	
82606	Heavy Dutry	OBS.	⊖	6	Porsche	9 Series	911	72-86	Rear		
82608	Heavy Dutry	OBS.	⊖	6.2	Fiat	124	Excl. Station Wagon	69-77	Rear	↔	
					Fiat	131	Supermirafiori, Superstrada	79-81	Rear	↔	
					Fiat	133	Mirafiori	77-78	Rear	↔	
82614	Heavy Dutry	OBS.	⊖	6.2	Fiat	124	Station Wagon	69-77	Front		
83021	Heavy Dutry	OBS.	⊗	8.5	Freightliner	Cab Over Tractors	Chassis cab	19..	cab shock		
83233	Heavy Dutry	OBS.	†	5	Bedford	CF Series	Van, Truck	70-84	Front	↔	
83367	Heavy Dutry		♀	9.2	Volkswagen	Caravelle	Caravelle T4	99-04	Rear	↔	
					Volkswagen	Kombi	Transporter T4: Mini bus, Pick-up & Panel van Excl. Syncro	99-04	Rear	↔	
83373	Heavy Dutry		⊖	6.2	Volkswagen	Caravelle	Caravelle T4	99-04	Front	↔	
83373	Heavy Dutry		⊖	6.2	Volkswagen	Kombi	Transporter T4: Mini bus, Pick-up & Panel van Excl. Syncro	99-04	Front	↔	
83450	Heavy Dutry		⊗	8.5	Mercedes-Benz	Sprinter	412D (903)	95 on	Rear	↔	
					Mercedes-Benz	Sprinter 412D	Truck	96 on	Rear	↔	
83454	Heavy Dutry		⊖	6.1	Toyota	Prado	90 SWB & 95 LWB	96-02	Rear	↔	
83455	Heavy Dutry		⊖	6.2	Toyota	Landcruiser	HDJ100, UZJ100 (Excl. Air Susp.)	98-02	Front	↔	
83456	Heavy Dutry		⊖	6.2	Toyota	Landcruiser	HDJ100, UZJ100 (Excl. Air Susp.)	98-02	Rear	↔	
					Toyota	Landcruiser	HDJ100/105, UZJ100/105 (Excl. Air Susp.)	98-02	Rear	↔	
85319	Heavy Dutry		⊗	8.5	Freightliner	FL112 Series	Truck	19..	Rear	↔	28
85320	Heavy Dutry		⊗	8.2	Freightliner	FL112 Series	Truck	19..	Front	↔	
85724	Heavy Dutry		⊗	8.5	Freightliner	Argosy 90 (Air Susp.)	Truck	19..	Rear	↔	
					Freightliner	FL112 Series	Truck	19..	Rear	↔	28
85918	Heavy Dutry		⊗	8.5	Freightliner	Argosy 90 (Air Susp.)	Truck	19..	Front	↔	

77023 - 85918



143057

PARTS LISTING

Shocks & Struts

143057 – G35199

Part #	Range	Superceding Part #/Status.	Product Type	Make	Model	Derivative	Year	Position	L/R	Note # (pg 6)
143057	Gabriel				Strut Cushion					
144273	Gabriel				Gas Filling Machine	Gaslifts				
144283	Gabriel				Hoses, Fittings & Trigger Valve	Gaslifts				
EG35040	Gas Ryder	OBS.	⚡ 1.1	BMW	3 Series	E36 Series (Imported 4 cyl. models)	91-99	Front	L	
EG35041	Gas Ryder	OBS.	⚡ 1.1	BMW	3 Series	E36 Series (Imported 4 cyl. models)	91-99	Front	R	
EG35042	Gas Ryder	OBS.	⚡ 1.1	BMW	3 Series	E36 Series (Imported 6 cyl. models)	91-99	Front	L	
EG35043	Gas Ryder	OBS.	⚡ 1.1	BMW	3 Series	E36 Series (Imported 6 cyl. models)	91-99	Front	R	
EG35046	Gas Ryder		⚡ 1.1	BMW	Z3	E36/4	98-03	Front	L	
EG35047	Gas Ryder		⚡ 1.1	BMW	Z3	E36/4	98-03	Front	R	
EG35115	Gas Ryder		⚡ 1.1	Opel	Omega	Sedan, Estate (B)	01-04	Front	↔	
EG35990	Gas Ryder	OBS.	⚡ 1.1	Opel	Senator	3.0i 24V	87-94	Front	↔	
EG63659	Gas Ryder		⊕ 8.4	Isuzu	Trooper	Mk II	92-96	Rear	↔	
G35013	Gas Ryder	OBS.	⚡ 1.1	Fiat	Croma	Excl. 2.0 Turbo	85-96	Front	↔	
				Lancia	Thema	Excl. 3.0 V8	84-94	Front	↔	
G35037	Gas Ryder	OBS.	⚡ 1.1	Alfa-Romeo	155	2.0 (Excl. ⚡)	96-98	Front	↔	
G35038	Gas Ryder	OBS.	⚡ 1.1	Alfa-Romeo	155	2.5 (Excl. ⚡)	96-98	Front	↔	
G35101	Gas Ryder	OBS.	⚡ 1.1	Alfa-Romeo	164	2.0, 3.0 (Excl. ⚡)	93-99	Rear	↔	
G35112	Gas Ryder		⚡ 1.1	Ford	Mondeo	Mk II	96-01	Rear	↔	
G35118	Gas Ryder	OBS.	⚡ 1.1	Renault	Safrane	Phase 2	97-02	Front	L	
G35119	Gas Ryder	OBS.	⚡ 1.1	Renault	Safrane	Phase 2	97-02	Front	R	
G35120	Gas Ryder	OBS.	⚡ 1.1	Renault	Safrane	Phase 2	97-02	Rear	↔	
G35128	Gas Ryder		⚡ 1.1	Volvo	850	Excl. ⚡, ⚡	94-97	Front	↔	
				Volvo	850	Excl. ⚡, ⚡	94-97	Front	↔	
G35146	Gas Ryder		⚡ 1.1	Ford	Escort	Mk V, VI, VII	95-99	Front	↔	
				Ford	Escort	Mk V, VI, VII	95-99	Front	↔	
G35150	Gas Ryder	OBS.	⚡ 1.1	Fiat	Ulysse	Eurovan	99-03	Front	↔	
				Peugeot	806	Eurovan MPV	95-03	Front	↔	
G35160	Gas Ryder	OBS.	⚡ 1.1	Alfa-Romeo	145, 146	2.0	96-99	Front	↔	
G35185	Gas Ryder	OBS.	⚡ 1.1	Alfa-Romeo	164	2.0, 3.0 (Excl. ⚡)	93-99	Front	↔	
G35189	Gas Ryder		⚡ 1.1	Ford	Mondeo	Mk II	96-01	Front	↔	
				Ford	Mondeo	Mk II (Excl. self levelling)	96-01	Front	↔	
G35190	Gas Ryder		⚡ 1.1	Volkswagen	Sharan	Mk I, Mk IA, Mk IB	95-10	Front	↔	
G35193	Gas Ryder	OBS.	⚡ 1.1	Peugeot	406	Saloon	96-04	Front	L	
				Peugeot	406	SW	96-02	Front	L	
G35199	Gas Ryder	OBS.	⚡ 1.1	Peugeot	406	Saloon	96-04	Front	R	
				Peugeot	406	SW	96-02	Front	R	

PARTS LISTING

Shocks & Struts

G35214



Part #	Range	Superceding Part #/Status.	Product Type	Make	Model	Derivative	Year	Position	L/R	Note # (pg 6)	
G35214	Gas Ryder		f	1.1	Fiat	Palio	Type 1X	00-02	Front	↔	
					Fiat	Palio	Weekend (Type PY)	00-02	Front	↔	
					Fiat	Siena	Type 2A	00-02	Front	↔	
G35216	Gas Ryder	OBS.	f	1.1	Alfa-Romeo	GTV, Spider	2.0 TS	95-05	Front	↔	
G35217	Gas Ryder	OBS.	f	1.1	Alfa-Romeo	GTV, Spider	3.0 V6	95-05	Front	↔	
G35220	Gas Ryder		f	1.1	Volvo	S40	Excl. & T4 rear (Mk I)	95-04	Front	L	
G35222	Gas Ryder	OBS.	f	1.1	Alfa-Romeo	156	2.0 Twin Spark (932) (Excl.) (Right VETO116245)	97-98	Rear	↔	
G35225	Gas Ryder		f	1.1	Volvo	S40	Excl. & T4 rear (Mk I)	95-04	Front	R	
G35227	Gas Ryder		f	1.1	BMW	5 Series	E39 Series (535i, 540i) (Excl.)	96-04	Front	↔	
G35228	Gas Ryder		f	1.1	BMW	5 Series	E39 Series (520i, 523i, 525i, 525TDS, 528i, 530i, 530D) (Excl.)	96-04	Front	↔	
G35279	Gas Ryder		f	1.1	Fiat	Seicento	600	99-03	Front	↔	
G35280	Gas Ryder	OBS.	f	1.1	Alfa-Romeo	156	2.0 Twin Spark (932) (Excl.) (VETO116246 Right)	98-06	Rear	↔	
G35284	Gas Ryder	OBS.	f	1.1	Hyundai	Atoz	Mk I	97-98	Front	L	
G35288	Gas Ryder	OBS.	f	1.1	Alfa-Romeo	156	2.5 V6 (932) Y (VETO116246 Right)	98-06	Rear	↔	
G35289	Gas Ryder		f	1.1	Opel	Zafira	A	01-06	Front	L	
G35290	Gas Ryder		f	1.1	Opel	Zafira	A	01-06	Front	R	
G35292	Gas Ryder		f	1.1	Volvo	C70	Excl. T5 (Mk I)	97-05	Front	↔	
G35292	Gas Ryder		f	1.1	Volvo	S70, V70	Excl.	97-00	Front	↔	
G35295	Gas Ryder		f	1.1	Daewoo	Matiz	Spark	99-03	Front	L	
G35296	Gas Ryder		f	1.1	Ford	Focus	Mk I Hatch & Sedan	98-04	Front	L	
G35299	Gas Ryder	OBS.	f	1.1	Hyundai	Atoz	Mk I	97-98	Front	R	
G35300	Gas Ryder		f	1.1	Daewoo	Matiz	Spark	03-05	Front	R	
G35301	Gas Ryder		f	1.1	Ford	Focus	Mk I Hatch & Sedan	98-04	Front	R	
G35305	Gas Ryder	70511	f	1	Renault	Megane	Mk I (Excl. Coupe)	96-03	Front	↔	
G35305	Gas Ryder	70511	f	1	Renault	Scenic	Mk I (Excl. 4X4)	98-04	Front	↔	
G35326	Gas Ryder		f	1.1	Ford	KA	1.3 (Mk I)	05-08	Front	↔	
G35337	Gas Ryder		f	1.1	Peugeot	206	1.4Hdi, 2.0Hdi	04-07	Front	R	
					Peugeot	206	1.6 Estate	03-07	Front	R	
					Peugeot	206	2.0 GTi	00-06	Front	R	
G35338	Gas Ryder		f	1.1	Peugeot	206	1.4Hdi, 2.0Hdi	04-07	Front	L	
					Peugeot	206	1.6 Estate	03-07	Front	L	
					Peugeot	206	2.0 GTi	00-06	Front	L	
G35343	Gas Ryder	OBS.	f	1.1	Renault	Espace	III	97-04	Front	L	
G35344	Gas Ryder	OBS.	f	1.1	Renault	Espace	III	97-04	Front	R	
G35347	Gas Ryder	OBS.	f	1.1	Peugeot	306	Hatchback, Saloon & Cabriolet (Excl. Estate)	93-02	Front	L	
					Peugeot	Partner	Van, LAV	99-02	Front	L	

G35214 - G35347



G35348 – G45006

Part #	Range	Superceding Part #/Status.	Product Type	Make	Model	Derivative	Year	Position	L/R	Note # (pg 6)
G35348	Gas Ryder	OBS.	⚡ 1.1	Peugeot	306	Hatchback, Saloon & Cabriolet (Excl. Estate)	93-02	Front	R	
				Peugeot	Partner	Van, LAV	99-02	Front	R	
G35365	Gas Ryder		⚡ 1.1	Mercedes-Benz	A Class	(W168) A160, A190, 170CDI	00-04	Front	↔	
G35369	Gas Ryder		⚡ 1.1	Peugeot	307	1.6, 2.0 Excl. CC	01-08	Front	L	
				Peugeot	307	Estate	02-08	Front	L	
G35370	Gas Ryder		⚡ 1.1	Peugeot	307	1.6, 2.0 Excl. CC	01-08	Front	R	
				Peugeot	307	Estate	02-08	Front	R	
G35412	Gas Ryder	OBS.	⚡ 1.1	Peugeot	206	CC 1.6, CC 2.0	01-07	Front	L	
G35413	Gas Ryder	OBS.	⚡ 1.1	Peugeot	206	CC 1.6, CC 2.0	01-07	Front	R	
G35421	Gas Ryder		⚡ 1.1	Renault	Megane	II Hatch (Excl. 2.0 T Sport)	04-08	Front	↔	
G35451	Gas Ryder		⚡ 1.1	Renault	Scenic	Grand Scenic II	04-09	Front	↔	
				Renault	Scenic	Scenic II	04-09	Front	↔	
G44450	Gas Ryder	61303	/ 2	Audi	100, 200	C2	77-84	Front	↔	
G44461	Gas Ryder	OBS.	/ 2	Saab	9-3	SE 2.0, 2.0 Turbo, 2.3 (Mk I)	98-04	Front	↔	
G44705	Gas Ryder	OBS.	/ 2	Fiat	133	Mirafori	77-78	Front	↔	
G44706	Gas Ryder	OBS.	/ 2	BMW	2 Series	1502, 2002 Ti Lux (E10)	66-77	Front	↔	
G44733	Gas Ryder	OBS.	/ 2	Fiat	X 1/9	1300 (with serviceable struts)	77-80	Front	↔	
				Fiat	X 1/9	1500 (with serviceable struts)	81-85	Front	↔	
				Fiat	X 1/9	1300 (with serviceable struts)	77-80	Rear	↔	
G44735	Gas Ryder	OBS.	/ 2	Mazda	RX7	Coupe	81-85	Front	↔	
G44742	Gas Ryder	OBS.	/ 2	Suzuki	Carry	Mk VIII	82-85	Front	↔	
G44773	Gas Ryder	OBS.	/ 2	Honda	Prelude	Coupe	83-87	Rear	↔	
G44782	Gas Ryder		/ 2	Toyota	Rav4	Serviceable struts (XA10)	96-98	Front	↔	
G44850	Gas Ryder	OBS.	/ 2	Porsche	9 Series	924	76-85	Front	↔	
				Porsche	9 Series	944	81-85	Front	↔	
				Porsche	9 Series	944	86-88	Front	↔	
G44869	Gas Ryder	OBS.	/ 2	Nissan	Z' Series	240Z, 260Z, 280Z (S30)	70-81	Front	↔	
				Nissan	Z' Series	280ZX (S130)	78-83	Front	↔	
G44895	Gas Ryder	OBS.	/ 2	Porsche	9 Series	911	72-86	Front	↔	
G44938	Gas Ryder	OBS.	/ 2	Toyota	Celica, Supra	A40, A50 (Mk II)	77-81	Front	↔	
G44939	Gas Ryder	OBS.	/ 2	Toyota	Celica, Supra	A60 Series (Mk III)	81-85	Front	↔	
G45001	Technomatic		⊕ 5	Toyota	Tuv	LDV	82-87	Front	↔	
				Volvo	122	Amazon	62-71	Front	↔	
				Volvo	122	Amazon, B18	59-71	Front	↔	
G45006 (Cont. on next page)	Technomatic		⊗ 8.2	Chevrolet	Luv	Faster	73-78	Rear	↔	
				Dodge (Chrysler)	Husky	LDV	74-78	Rear	↔	3
				Jeep (Chrysler)	Jeep	CJ Series (Willys) (CJ5, CJ6, CJ7)	54-86	Rear	↔	
				Fiat	124	Station Wagon	69-77	Rear	↔	
				Isuzu	KB (D-Max), TF Series	(Mk I)	78-80	Rear	↔	

PARTS LISTING

Shocks & Struts

G45006



Part #	Range	Superceding Part #/Status.	Product Type	Make	Model	Derivative	Year	Position	L/R	Note # (pg 6)
G45006 (From previous page)	Technomatic		⊙ 8.2	Isuzu	WFR, Relay	Fargo	80-95	Rear	↔	
				Nissan	Stanza	1600J, 1800J, Stanza Station Wagon (A10)	79-83	Rear	↔	
				Toyota	Condor	4X4 Mk IV	00-05	Rear	↔	
				Toyota	Corona	T60, T70 Series (Mark II 1900)	69-73	Rear	↔	
				Toyota	Hi-Ace	H10	69-84	Rear	↔	
				Toyota	Hilux	4X2	69-84	Rear	↔	
				Toyota	Stout	RK 101	61-89	Rear	↔	
				Toyota	Tuv	LDV	82-87	Rear	↔	
G45008	Technomatic		⊙ 8.2	Isuzu	KB (D-Max), TF Series	4X2 (Std. Height) (TF)	89-04	Rear	↔	
				Isuzu	KB (D-Max), TF Series	4X4, 4X2 (Raised Height) (TF)	89-04	Rear	↔	
				Nissan	Laurel	240, 260, 300 (C130)	72-78	Rear	↔	13
				Toyota	Hilux	4X2 Std. Susp.	99-05	Rear	↔	
				Toyota	Hilux	4X4	79-84	Rear	↔	
				Toyota	Landcruiser	FJ45, BJ45	71-85	Rear	↔	
G45051	Technomatic		⊙ 8.2	Jeep (Chrysler)	Jeep	CJ Series (Willys) (CJ5, CJ6, CJ7)	54-86	Front	↔	
				Toyota	Landcruiser	FJ45, BJ45	71-85	Front	↔	
				Ford	Husky	LDV, Panel van	86-93	Rear	↔	
				Hillman	Vogue, Hunter	Safari	67-77	Rear	↔	
				Hyundai	H100	Bakkie	96-05	Rear	↔	
				Mitsubishi	L300 (Delica)	Incl. Starwagon, Express	82-03	Rear	↔	
				Nissan	1 Ton Bakkie	720 4X2	80-88	Rear	↔	
				Nissan	1/2 Ton Bakkie	120Y (12" wheels)	76-83	Rear	↔	
				Nissan	1/2 Ton Bakkie	1400 (13" wheels)	80-83	Rear	↔	
				Nissan	1/2 Ton Bakkie	1400, 1200, 120Y	71-08	Rear	↔	
				Nissan	Caball	Truck	64-78	Rear	↔	
				Nissan	Vanette	C22	85-85	Rear	↔	
				Nissan	Y Series	140Y, 160Y	75-80	Rear	↔	
				Toyota	Stallion	KF40	87-00	Rear	↔	
Toyota	Venture	KF40	91-00	Rear	↔					
G45054	Technomatic		⊙ 8.2	Suzuki	SJ410/413, Samurai	4X4, Station Wagon	82-87	Rear	↔	
				Toyota	Hi-Ace	SWB (H20, H30, H40)	84-88	Rear	↔	
				Volvo	122	Amazon	62-71	Rear	↔	
G45078	Technomatic		⊕ 5	Ford	Laser, Meteor, Tracer	Familia	69-76	Rear	↔	
				Ford	Ranchero	Falcon	69-76	Rear	↔	
				Mazda	1200, 1300	Familia (Mk II)	72-75	Rear	↔	
				Mazda	B Series, Drifter, Magnum	Mk II, II & IV	64-86	Rear	↔	
				Mazda	E2000, E2700, E3000	LDV	64-83	Rear	↔	
				Mazda	E2000, E3000	Truck	67-81	Rear	↔	
				Mazda	F1000, F1300	LDV	81-86	Rear	↔	
				Triumph	Chicane	2000, 2500	65-78	Rear	↔	

G45006 – G45078



Part #	Range	Superceding Part #/Status.	Product Type	Make	Model	Derivative	Year	Position	L/R	Note # (pg 6)
G45122	Technomatic		⊖ 6.1	Alfa-Romeo	Other	Incl. Giulia	66-77	Front	↔	
				Nissan	E20 (Urvan, Caravan)	Ekonowagon, Ekonovan	73-81	Front	↔	
				Suzuki	SJ410/413, Samurai	4X4, Station Wagon	82-87	Front	↔	
				Suzuki	SJ410/413, Samurai	4X4, Station Wagon	87-90	Front	↔	
				Nissan	Y Series	1200	72-75	Rear	↔	
G45138	Technomatic		⊖ 6.1	Nissan	Caball	Truck	64-78	Front	↔	
				Nissan	Caball	Truck	78-84	Front	↔	
				Toyota	Stout	RK 101	61-89	Front	↔	
				Opel	Rekord	Caravan (E)	78-92	Rear	↔	
G45212	Technomatic		⊖ 4	Mazda	B Series, Drifter, Magnum	Mk II, II & IV	64-86	Front	↔	
				Chevrolet	2500, 3800, 4100	2.5, 3.8, & 4.1 Estate	75-78	Front	↔	
				Chevrolet	2500, 3800, 4100	2.5, 3.8, & 4.1 Sedan	73-78	Front	↔	
				Opel	Rekord	C	67-73	Front	↔	
G45255	Technomatic		⊖ 4	Chevrolet	El Camino	Incl. El Toro	71-72	Front	↔	
				Nissan	Laurel	2000, 2300, 2400 (C30)	68-72	Front	↔	
				Nissan	Laurel	240, 260, 300 (C130)	72-78	Front	↔	
				Opel	Constantia, Kommando	Brougham	69-72	Front	↔	
G45258	Technomatic		⊖ 5	Peugeot	404	Saloon	60-78	Rear	↔	
				Peugeot	504	L, GR	76-85	Rear	↔	
				Rambler	Hornet & Sportabout	AMC	70-76	Rear	↔	
G45398	Technomatic		⊖ 4	Toyota	Corona	T100 Series	74-80	Front	↔	
				Toyota	Corona	Mk II 2000	72-78	Front	↔	
				Toyota	Corona	T60, T70 Series (Mark II 1900)	69-73	Front	↔	
				Toyota	Corona	T40, T50 Series (Incl. 2000 GSL)	64-74	Front	↔	
				Toyota	Hilux	4X2	69-84	Front	↔	
				Volvo	144, 164	B20, B30	68-71	Front	↔	
				Volvo	144, 164	B20E, B30	72-74	Front	↔	
G45399	Technomatic		⊖ 6.1	Chevrolet	2500, 3800, 4100	2.5, 3.8, & 4.1 Estate	75-78	Rear	↔	
				Chevrolet	Commodore	C	78-92	Rear	↔	
				Opel	2500, 3800, 4100	2.5, 3.8, & 4.1 Estate	75-78	Rear	↔	
				Opel	Commodore	C	78-92	Rear	↔	
				Toyota	Corolla	Imported strut (E30, E40, E50, E60)	74-80	Rear	↔	
				Toyota	Corolla	Imported strut (E30, E40, E50, E60)	82-85	Rear	↔	
				Toyota	Corolla Carri	Imported strut	73-79	Rear	↔	
				Toyota	Corolla Carri	Local strut (E30, E40, E50, E60)	79-89	Rear	↔	
				Toyota	Corona	Mk II 2000	72-78	Rear	↔	
				Toyota	Corona	T40, T50 Series (Incl. 2000 GSL)	64-74	Rear	↔	
				Toyota	Cressida	X35, X36 (Imported strut) (Mk I)	78-79	Rear	↔	
				Toyota	Cressida	X35, X36 (local strut) (Mk I)	79-81	Rear	↔	

PARTS LISTING

Shocks & Struts

G45413



G45413 – G45489

Part #	Range	Superceding Part #/Status.	Product Type	Make	Model	Derivative	Year	Position	L/R	Note # (pg 6)
G45413	Technomatic		☉ 8.5	Ford	Escort	Mk I	68-73	Rear	↔	
				Ford	Escort	Mk I 1100, 1300	70-75	Rear	↔	
				Ford	Escort	Mk I 1600, GT	70-75	Rear	↔	
				Ford	Escort	Mk I, II	74-81	Rear	↔	
G45417	Technomatic		☉ 8.5	Volkswagen	1500, 1600	Type 3 car	63-69	Front	↔	
				Volkswagen	Kombi	Microbus (double jointed axle rear)	68-80	Front	↔	
G45418	Technomatic		☉ 8.2	Ford	Cortina	Mk III, IV	71-78	Rear	↔	20
				Volkswagen	Kombi	Microbus (double jointed axle rear)	68-80	Rear	↔	
G45419	Technomatic		☉ 8.5	Volkswagen	Beetle	Mk I	52-79	Front	↔	4
				Volkswagen	Kombi	Microbus, Fleetline (swing axle rear)	55-78	Front	↔	
				Volkswagen	1500, 1600	Type 3 car	63-69	Rear	↔	
				Volkswagen	Beetle	Mk I	52-79	Rear	↔	4
				Volkswagen	Kombi	Microbus, Fleetline (swing axle rear)	55-78	Rear	↔	
G45423	Technomatic		☽ 6.1	Fiat	125	Sedan	69-75	Rear	↔	
				Ford	Taurus	17M, 20M	61-73	Rear	↔	19
				Nissan	Laurel	2000, 2300, 2400 (C30)	68-72	Rear	↔	
				Nissan	U Series	1600, 1800 (Incl. Coupe)	72-73	Rear	↔	
				Nissan	U Series	160U, 180U	74-78	Rear	↔	
G45432	Technomatic		☽ 9.1	Nissan	1 Ton Bakkie	620, 680, 1300, 1500	66-80	Rear	↔	
				Nissan	Caball	Truck	78-84	Rear	↔	
				Nissan	E20 (Urvan, Caravan)	Ekonowagon, Ekonovan	73-81	Rear	↔	
				Nissan	E20 (Urvan, Caravan)	Ekonowagon, Ekonovan	81-95	Rear	↔	
G45447	Technomatic		☉ 8.5	Chevrolet	Nomad	LDV	75-78	Front	↔	
				Nissan	Vanette	C22	85-85	Front	↔	6
				Opel	Firenza	Coupe	71-78	Front	↔	
G45450	Technomatic		☽ 6.2	Peugeot	505	Saloon	80-85	Rear	↔	
G45459	Technomatic	OBS.	☽ 6.2	Volkswagen	411, 412	Type 4	69-75	Rear	↔	
G45466	Technomatic		☽ 4	Chevrolet	Chevelle	Mk I	64-70	Front	↔	
				Ford	Husky	LDV, Panel van	86-93	Front	↔	
				Mitsubishi	L300 (Delica)	Incl. Starwagon, Express	82-03	Front	↔	
				Toyota	Condor	4X2 Mk IV	00-05	Front	↔	
				Toyota	Hi-Ace	H10	69-84	Front	↔	
G45468	Technomatic	OBS.	☉ 8.5	Peugeot	404	LDV	60-81	Rear	↔	
G45469	Technomatic		☽ 6.1	Toyota	Cressida	MX63 (Mk II)	81-93	Rear	↔	
G45470	Technomatic		☉ 8.5	Peugeot	404	Estate	69-78	Rear	↔	
				Peugeot	504	Estate	74-85	Rear	↔	
				Peugeot	504	GL, GLD, Ti	73-80	Rear	↔	
G45489	Technomatic		☽ 6.2	Opel	2500, 3800, 4100	2.5, 3.8, & 4.1 Sedan	73-78	Rear	↔	
				Chevrolet / Opel	Ascona, Chevair	B, (Mk I Cavalier)	76-82	Rear	↔	
				Opel	Commodore	C	78-88	Rear	↔	
				Opel	Rekord	Sedan (Excl. V6) (E)	78-97	Rear	↔	



Part #	Range	Superceding Part #/Status.	Product Type		Make	Model	Derivative	Year	Position	L/R	Note # (pg 6)
G45503	Technomatic		☉	10	Ford	Cortina	Mk III	71-77	Front	↔	
					Ford	Cortina	Mk IV	77-80	Front	↔	
					Ford	Granada	Mk I, Mk II	72-86	Front	↔	
G45520	Technomatic		☉	8.5	Ford	Cortina	Mk III	71-77	Rear	↔	
					Ford	Cortina	Mk IV	77-80	Rear	↔	
					Ford	Cortina	Mk V	80-83	Rear	↔	
G45523	Technomatic		⊥	4	Mazda	F1000, F1300	LDV	81-86	Front	↔	
G45532	Technomatic		⊥	4	BMW	2 Series	1802, 2002 (E10)	68-75	Front	↔	
					Chevrolet	El Camino	Incl. El Toro	72-78	Front	↔	
					Opel	Constantia, Kommando	Incl., Caprice, De Ville (AQ)	72-79	Front	↔	
G45533	Technomatic		☉	6.1	Nissan	Y Series	140Y, 160Y	75-80	Rear	↔	
					Opel	Constantia, Kommando	Brougham	69-72	Rear	↔	
					Opel	Constantia, Kommando	Incl., Caprice, De Ville (AQ)	72-79	Rear	↔	
					Opel	Firenza	Coupe	71-78	Rear	↔	2
					Opel	Kadett	B	66-74	Rear	↔	
					Opel	Rekord	C	67-73	Rear	↔	
					Chevrolet	El Camino	Incl. El Toro	71-72	Rear	↔	
G45534	Technomatic		☉	8.4	Chevrolet	El Camino	Incl. El Toro	72-78	Rear	↔	
G45535	Technomatic		☉	6.2	Chevrolet	Luv	Faster	73-78	Front	↔	
					Hyundai	H100	Bakkie	96-05	Front	↔	
					Isuzu	KB (D-Max), TF Series	(Mk I)	78-80	Front	↔	
					Isuzu	KB (D-Max), TF Series	4X4 (Mk II)	80-88	Front	↔	
					Jaguar	Jaguar	Mk II	61-69	Front	↔	1
					Jaguar	Jaguar	Mk X, 420, 420G, S Type (4 shocks at rear)	65-72	Front	↔	1
					Nissan	E20 (Urvan, Caravan)	Ekonowagon, Ekonovan	81-95	Front	↔	
					Toyota	Condor	4X4 Mk IV	00-05	Front	↔	
G45538	Technomatic	OBS.	☉	8.4	Dodge (Chrysler)	Colt	1600, 2000	72-77	Rear	↔	
					Mitsubishi	Colt	Dodge 1600, 2000, (Incl. Coupe)	72-77	Rear	↔	
G45651	Technomatic		⊥	4	Ford	Granada	Mk I, Mk II	72-86	Rear	↔	
G45666	Technomatic		⊥	4	Alfa-Romeo	Alfetta, Giulietta, Super, 159i	Incl. GT, GTV	73-86	Front	↔	
G45667	Technomatic		⊥	5	Mazda	E2000, E2700, E3000	LDV	64-83	Front	↔	
					Mazda	E2000, E3000	Truck	67-81	Front	↔	
					Alfa-Romeo	Alfetta, Giulietta, Super, 159i	Incl. GT, GTV	73-86	Rear	↔	
G45715	Technomatic		☉	8.5	Audi	80	B1	75-81	Rear	↔	
					Volkswagen	Passat	B1	74-81	Rear	↔	
G45742	Technomatic		☉	6.2	Ford	Escort	Mk II	75-81	Rear	↔	
G45810	Technomatic		☉	8.4	Fiat	132	Supermirafiori	79-81	Rear	↔	
					Mazda	323	RWD (Imported strut)	77-78	Rear	↔	
					Mazda	323	RWD (local strut)	78-81	Rear	↔	

PARTS LISTING

Shocks & Struts

G45812



G45812 – G45869

Part #	Range	Superceding Part #/Status.	Product Type		Make	Model	Derivative	Year	Position	L/R	Note # (pg 6)
			Symbol	Value							
G45812	Technomatic		⊗	8.4	Mitsubishi	Colt	Galant (Imported strut)	77-78	Rear	↔	
					Mitsubishi	Colt	Galant (local strut)	78-83	Rear	↔	
G45813	Technomatic		⊗	6.1	Toyota	Cressida	Non IRS+, MX63 (Mk II)	81-93	Rear	↔	
					Toyota	Cressida	X30, X32 (Imported strut) (Mk I)	77-79	Rear	↔	
					Toyota	Cressida	X30, X32 (local strut) (Mk I)	79-81	Rear	↔	
G45824	Technomatic		⊗	8.5	Mitsubishi	Tredia	Excl. Turbo	83-86	Rear	↔	
					Mitsubishi	Tredia	Turbo	83-86	Rear	↔	
G45837	Technomatic		⊗	10	Ford	Cortina	Mk V	80-83	Front	↔	
					Ford	Cortina	Mk V	80-83	Front	↔	
G45838	Technomatic		⊗	6.2	Ford	Cortina	Mk V	80-83	Rear	↔	14
G45839	Technomatic		⊗	6.2	Chevrolet / Opel	Ascona, Chevir	Incl. Coupe (C)	82-85	Rear	↔	
					Chevrolet / Opel	Ascona, Chevir	Incl. Coupe (short strut) (C)	84-86	Rear	↔	
					Opel	Kadett	D	80-85	Rear	↔	
					Opel	Kadett	T-car (E)	85-89	Rear	↔	
					Opel	Monza	Incl. GSi	86-89	Rear	↔	
G45841	Technomatic		⊗	6.1	Toyota	Corolla	RWD (Excl. Van, Station Wagon) (E70)	80-85	Rear	↔	
					Toyota	Corona	T100 Series	74-80	Rear	↔	
G45842	Technomatic		⊗	6.2	Nissan	1 Ton Bakkie	620, 680, 1300, 1500	66-80	Front	↔	
					Nissan	1 Ton Bakkie	720 4X2	80-88	Front	↔	
					Nissan	1 Ton Bakkie	Hardbody 4X4 (Incl. Sani, Patrol) (D21)	88-02	Front	↔	
					Nissan	Sani	4X4	90-99	Front	↔	
					Nissan	Tracker	4X4	80-82	Front	↔	
					Nissan	Tracker	4X4 (Incl. Sani)	82-88	Front	↔	
G45844	Technomatic		⊗	6.2	Isuzu	KB (D-Max), TF Series	4X2 (Mk II)	80-88	Front	↔	
					Isuzu	KB (D-Max), TF Series	4X2 (Std. Height) (TF)	89-04	Front	↔	
G45858	Technomatic		⊕	4	Ford	Sierra, Sapphire	Estate	83-93	Rear	↔	
G45859	Technomatic		⊗	6.2	Nissan	Langley, Pulsar	Incl. Exa (sealed strut) (N12)	83-88	Rear	↔	
G45860	Technomatic		⊗	8.5	Ford	Sierra, Sapphire	2300, 2000, 1600	83-93	Rear	↔	
					Ford	Sierra, Sapphire	3000 (Incl. XR6)	83-93	Rear	↔	
G45861	Technomatic		⊗	6.2	BMW	2 Series	1802, 2002 (E10)	68-75	Rear	↔	
					Daihatsu	Charade	Incl. Coupe (G11)	83-87	Rear	↔	
G45862	Technomatic		⊕	4	GWM	GWM	2.2, 2.8TDi (4X2)	07 on	Front	↔	
					Toyota	Hilux	4X2	84-98	Front	↔	
					Toyota	Hilux	4X2 Std. Susp.	99-05	Front	↔	
G45869	Technomatic		⊗	6.2	Nissan	1 Ton Bakkie	Hardbody 4X2 (Excl. Hi Rider) (D21)	88-02	Front	↔	
					Nissan	1 Ton Bakkie	Hardbody 4X2 (Excl. Hi Rider) (D22)	02 on	Front	↔	
					Nissan	NP300	4X2 (Excl. Hi Rider) (D22)	08 on	Front	↔	
					Toyota	Hi-Ace	LWB (H20, H30, H40)	84-93	Front	↔	
					Toyota	Hi-Ace	SWB (H20, H30, H40)	84-88	Front	↔	
					Toyota	Hi-Ace	SWB (H50)	88-93	Front	↔	



Part #	Range	Superceding Part #/Status.	Product Type	Make	Model	Derivative	Year	Position	L/R	Note # (pg 6)
G45870	Technomatic		8.2	Ford	Spectron	Minibus, Van	91-03	Rear	↔	
				GWM	GWM	2.2, 2.8TDi (4X2)	07 on	Rear	↔	
				Isuzu	KB (D-Max), TF Series	4X2 (Mk II)	80-88	Rear	↔	
				Isuzu	KB (D-Max), TF Series	4X4 (Mk II)	80-88	Rear	↔	
				Mazda	Marathon (Ford Husky)	Van, Bus	91-03	Rear	↔	
				Nissan	Tracker	4X4 (Incl. Sani)	82-88	Rear	↔	
				Toyota	Hilux	4X2	84-98	Rear	↔	
G45871	Technomatic		6.2	Ford	Courier	4X2 (Std. Susp.)	86-06	Front	↔	
				Ford	Ranger	4X2 (Std. Susp.)	86-06	Front	↔	
				Isuzu	KB (D-Max), TF Series	4X4, 4X2 (Raised Height) (TF)	89-04	Front	↔	
				Mazda	B Series, Drifter, Magnum	4X2 Std. Susp.	86-06	Front	↔	
G45872	Technomatic		8.2	Ford	Courier	4X2 (Std. Susp.)	86-06	Rear	↔	
				Ford	Ranger	4X2 (Std. Susp.)	86-06	Rear	↔	
				Mazda	B Series, Drifter, Magnum	4X2 Std. Susp.	86-06	Rear	↔	
				Mitsubishi	Colt Bakkie	L200 (4X2 Std. height)	98-07	Rear	↔	
				Nissan	1 Ton Bakkie	Hardbody 4X2 (Excl. Hi Rider) (D21)	88-02	Rear	↔	
				Nissan	1 Ton Bakkie	Hardbody 4X2 Hi Rider (D21)	88-02	Rear	↔	
				Nissan	1 Ton Bakkie	Hardbody 4X4 (Incl. Sani, Patrol) (D21)	88-02	Rear	↔	
				Nissan	Sani	4X2	90-99	Rear	↔	
				Nissan	Sani	4X4	90-99	Rear	↔	
G45873	Technomatic		8.2	Toyota	Hi-Ace	LWB (H20, H30, H40)	84-93	Rear	↔	
				Toyota	Hi-Ace	SWB (H50)	88-93	Rear	↔	
G45874	Technomatic		6.2	Daewoo	Cielo	Nexia	95-98	Rear	↔	14
				Daewoo	Espero	Aranos	95-98	Rear	↔	14
				Daewoo	Lanos	Sens	97-03	Rear	↔	14
				Opel	Astra	F	93-99	Rear	↔	14
				Opel	Kadett	Astra	93-99	Rear	↔	14
				Opel	Kadett	T-car (E)	89-93	Rear	↔	14
				Opel	Monza	Incl. Cub	89-93	Rear	↔	14
G45875	Technomatic		8.5	Ford	Bantam	1300, 1600	83-86	Rear	↔	
				Ford	Bantam	1400, 1600	86-94	Rear	↔	
				Mazda	Rustler	130, 160	85-86	Rear	↔	
				Mazda	Rustler	1400, 1600	86-94	Rear	↔	
G45876	Technomatic		4	Ford	Spectron	Minibus, Van	91-03	Front	↔	
				Mazda	Marathon (Ford Husky)	Van, Bus	91-03	Front	↔	
G45877	Technomatic		8.5	Volkswagen	Golf	Incl. Sport (Typ 14)	81-93	Rear	↔	
				Volkswagen	Golf	Pick-up	93-03	Rear	↔	
G45878	Technomatic		8.5	Ford	Bantam	1.3, 1.6	03-06	Rear	↔	
				Ford	Bantam	1.3, 1.6 (Mk III)	06 on	Rear	↔	
				Ford	Bantam	1.3, 1.6, 1.8D	02	Rear	↔	
				Ford	Bantam	1300, 1600	94-02	Rear	↔	
				Mazda	Rustler	1300, 1600	94-02	Rear	↔	

PARTS LISTING

Shocks & Struts

G45879



Part #	Range	Superceding Part #/Status.	Product Type	Make	Model	Derivative	Year	Position	L/R	Note # (pg 6)
G45879	Technomatic		6.2	Volkswagen	Polo	Mk V (Typ 6R) (Excl. GTi)	10 on	Rear	↔	
				Volkswagen	Polo	Mk IV	02-09	Rear	↔	
				Volkswagen	Polo	Vivo (Mk IV)	10 on	Rear	↔	
G45881	Technomatic		8.5	Opel	Astra	Excl. 2.0 OPC (G)	99-03	Rear	↔	
G45885	Technomatic		6.2	Mahindra	Scorpio	4X4	05 on	Front	↔	
G45886	Technomatic		8.4	Mahindra	Scorpio	4X2	05 on	Rear	↔	
				Mahindra	Scorpio	4X4	05 on	Rear	↔	
G45888	Technomatic		3.2	Toyota	Hilux	4X2 Std. Susp.	05 on	Front	L	
G45889	Technomatic		3.2	Toyota	Hilux	4X2 Std. Susp.	05 on	Front	R	
G45890	Technomatic		6.2	Toyota	Yaris	T1 1.0L, T3 1.3L (Mk II)	05-11	Rear	↔	
				Toyota	Yaris	T3 1.3L (Mk II)	06-11	Rear	↔	
G45891	Technomatic		8.5	Toyota	Avanza	1.3 & 1.5 (Xenia)	06 on	Rear	↔	
G45892	Technomatic		6.2	Mazda	Mazda 3	1.6, 2.0 Excl. MPS (Mk I)	04-09	Rear	↔	
G45893	Technomatic		6.2	Isuzu	KB (D-Max), TF Series	4X2 (Mk II)	80-88	Front	↔	
				Isuzu	KB (D-Max), TF Series	4X2 (Std. Height) (TF)	89-04	Front	↔	
				Lada	Niva	VAZ-2121	87-92	Front	↔	16
				Mitsubishi	Colt Bakkie	L200 (4X2 Raised height)	98-07	Front	↔	
				Nissan	1 Ton Bakkie	Hardbody 4X2 (Excl. Hi Rider) (D21)	88-02	Front	↔	
				Nissan	1 Ton Bakkie	Hardbody 4X2 (Excl. Hi Rider) (D22)	02 on	Front	↔	
				Nissan	1 Ton Bakkie	Hardbody 4X2 Hi Rider (D21)	88-02	Front	↔	
				Nissan	1 Ton Bakkie	Hardbody 4X2 Hi Rider (D22)	02 on	Front	↔	
				Nissan	NP300	4X2 (Excl. Hi Rider) (D22)	08 on	Front	↔	
				Nissan	NP300	4X2 Hi Rider (D22)	08 on	Front	↔	
				Toyota	Hi-Ace	LWB (H20, H30, H40)	84-93	Front	↔	
				Toyota	Hi-Ace	SWB (H20, H30, H40)	84-88	Front	↔	
Toyota	Hi-Ace	SWB (H50)	88-93	Front	↔					
G45894	Technomatic		6.2	Ford	Focus	Mk II Hatch & Sedan (Excl. Sti)	04-11	Rear	↔	
G45896	Technomatic		8.5	Chana	Star	Bakkie, Panel van, Minibus (Incl. Maxi Star)	06 on	Rear	↔	
G45897	Technomatic		6.2	Chevrolet	Spark	M300 (Excl. Lite)	10 on	Rear	↔	
G45898	Technomatic		3.2	Kia	Sorento	2.5D, 3.5 & 3.8 (Mk I)	02-09	Front	L	
G45899	Technomatic		3.2	Kia	Sorento	2.5D, 3.5 & 3.8 (Mk I)	02-09	Front	R	
G45900	Technomatic		6.2	Volkswagen	Golf IV	Estate	99-06	Rear	↔	
G45901	Technomatic	NEW	6.2	Suzuki	Jimny	Gen 3 - SN413 / JA/JB33	98 on	Front	↔	
G45902	Technomatic	NEW	8.5	Suzuki	Jimny	Gen 3 - SN413 / JA/JB33	98 on	Rear	↔	
G45904	Technomatic	NEW	3.2	GWM	Steed	Pick-Up 4X2	08 on	Front	↔	
G45905	Technomatic	NEW	8.2	GWM	Steed	Pick-Up 4X2	08 on	Rear	↔	
G51023	Gas Ryder		3.2	Audi	A4	1.8, 2.4, 2.6, 2.8 Excl. Quattro (B5)	94-01	Rear	↔	
G51059	Gas Ryder		3.2	Hyundai	Elantra	J1 Series (Avante)	94-96	Rear	↔	
G51082	Gas Ryder		3.2	Ford	Escort	Mk V	95-99	Rear	↔	
G51089	Gas Ryder	69082	3.3	Mazda	Soho	121 (Bracket)	97-99	Rear	↔	
G51099	Gas Ryder	OBS.	3	Audi	A4	Quattro Sport Susp. (B5)	94-01	Front	↔	

G45879 - G51099



G51101

PARTS LISTING

Shocks & Struts

G51101 – G55613

Part #	Range	Superceding Part #/Status.	Product Type	Make	Model	Derivative	Year	Position	L/R	Note # (pg 6)
G51101	Gas Ryder		† 3.3	Audi	A6	Excl. & Quattro (C5)	97-04	Front	↔	
				Audi	A6	Quattro (C5)	97-04	Front	↔	
G51186	Gas Ryder		† 3.2	Hyundai	Sonata	Y3	95-98	Rear	↔	
G51195	Gas Ryder	OBS.	† 3	Mazda	MX-5	Coupe	90-98	Front	↔	
G51196	Gas Ryder	OBS.	† 3.2	Mazda	MX-5	Coupe	90-98	Rear	↔	
G51213	Gas Ryder		† 3.2	Nissan	Primera	P11-144	98-02	Front	↔	
G51214	Gas Ryder		† 3.2	Nissan	Primera	P11-144	98-02	Rear	↔	
G51216	Gas Ryder		† 3.2	BMW	5 Series	E39 Series (520i, 523i, 525i, 525TDS, 528i, 530i, 530D) (Excl.)	96-04	Rear	↔	
				BMW	5 Series	E39 Series (535i, 540i) (Excl.)	96-04	Rear	↔	
G51217	Gas Ryder		† 3.1	Alfa-Romeo	156	2.0 Twin Spark (932) (Excl.) (Right VETO116245)	97-98	Front	↔	
				Alfa-Romeo	156	2.0 Twin Spark (932) (Excl.) (VETO116246 Right)	98-06	Front	↔	
G51227	Gas Ryder	OBS.	† 3	Kia	Sportage	2.0, 2.0D (Mk I)	93-04	Front	↔	
G51231	Gas Ryder		† 3.1	Alfa-Romeo	147	1.6 (937), 2.0	01 on	Front	↔	
				Alfa-Romeo	156	2.5 V6 (932) (Right VETO116245)	97-98	Front	↔	
				Alfa-Romeo	156	2.5 V6 (932) (VETO116246 Right)	98-06	Front	↔	
G51235	Gas Ryder	69095	† 3.2	Ford	Fiesta	Mk IV (Excl. 1.6 RSi 3-Door) (Sleeve eye)	99-03	Rear	↔	22
				Ford	Ikon	B3 (Sleeve eye)	00-06	Rear	↔	22
				Mazda	Soho	121 (Eye)	97-99	Rear	↔	22
G51238	Gas Ryder	OBS.	† 3.1	Alfa-Romeo	166	3.0 V6 Sportronic	98-06	Front	↔	
G51239	Gas Ryder	OBS.	† 3.2	Alfa-Romeo	166	3.0 V6 Sportronic	98-06	Rear	↔	
G51255	Gas Ryder		† 3.1	Honda	CR-V	RD1-RD3	95-01	Front	↔	
G51256	Gas Ryder		† 3.2	Honda	CR-V	RD1-RD3	95-01	Rear	↔	
G51269	Gas Ryder		† 3.2	Volvo	S40	Excl. , & T4 rear (Mk I)	95-04	Rear	↔	
G51275	Gas Ryder		† 3.2	Ford	KA	1.3 (Mk I)	05-08	Rear	↔	
G51298	Gas Ryder		† 3.2	Honda	Civic	Mk VII	01-05	Rear	↔	
G51323	Gas Ryder	OBS.	† 3	Renault	Fuego	3-Door Hatchback	80-85	Front	↔	
G54023	Gas Ryder		† 1.1	Hyundai	Accent	MC. 1.6	05-11	Front	L	
G54024	Gas Ryder		† 1.1	Hyundai	Accent	MC. 1.6	05-11	Front	R	
G55514	Gas Ryder	OBS.	† 1.1	Chevrolet	Lumina	APV	90-95	Front	↔	
				Chevrolet	Lumina	Van	90-95	Front	↔	
G55516	Gas Ryder	OBS.	† 1.1	Honda	Prelude	Coupe (sealed struts rear)	83-87	Rear	↔	
G55586	Gas Ryder	OBS.	† 1.1	Hyundai	Scoupe	Coupe	94-96	Front	↔	
G55592	Gas Ryder		† 1.1	Hyundai	Elantra	J1 Series (Avante)	94-96	Front	↔	
G55600	Gas Ryder		† 1.1	Mazda	626	Zimbabwe model	87-91	Front	↔	
G55601	Gas Ryder		† 1.1	Mazda	626	Zimbabwe model	87-91	Rear	↔	
G55613	Gas Ryder	G56518	† 1.1	Suzuki	Vitara	5-Door (Excl. V6) (Mk I)	94-98	Front	↔	

PARTS LISTING

Shocks & Struts

G55614



Part #	Range	Superceding Part #/Status.	Product Type	Make	Model	Derivative	Year	Position	L/R	Note # (pg 6)
G55614	Gas Ryder	G56518	⚡ 1.1	Suzuki	Vitara	5-Door (Excl. V6) (Mk I)	94-98	Front	↔	
G55652	Gas Ryder	OBS.	⚡ 1.1	Toyota	Previa	(2.7, 2.5 D-4D) (Bus, LWB Panel Van) (H200)	90-99	Front	L	
G55653	Gas Ryder	OBS.	⚡ 1.1	Toyota	Previa	(2.7, 2.5 D-4D) (Bus, LWB Panel Van) (H200)	90-99	Front	R	
G55673	Gas Ryder		⚡ 1.1	Hyundai	Sonata	Y3	95-98	Front	↔	
G55679	Gas Ryder	OBS.	⚡ 1.1	Chrysler	Neon	1	93-99	Front	↔	
G55680	Gas Ryder	OBS.	⚡ 1.1	Chrysler	Neon	1	93-99	Rear	↔	
G55695	Gas Ryder	OBS.	⚡ 1.1	Ford	Falcon, Fairlane	Futura, Fairmont	96-99	Front	↔	
				Ford	Falcon, Fairlane	Futura, Fairmont	96-99	Front	↔	
G55695	Gas Ryder	OBS.	⚡ 1.1	Ford	Ranchero	Falcon	97-98	Front	↔	
G55697	Gas Ryder		⚡ 1.1	Chrysler	Voyager	Gen III (Incl. Grande Voyager) (Excl. ⓈI)	96-00	Front	↔	
G55723	Gas Ryder		⚡ 1.1	Honda	Prelude	Coupe	83-87	Front	↔	
				Honda	Prelude	Coupe (sealed struts rear)	83-87	Front	↔	
G55757	Gas Ryder	OBS.	⚡ 1.1	Honda	Prelude	Coupe	87-92	Rear	↔	
G55760	Gas Ryder	OBS.	⚡ 1.1	Honda	Prelude	Coupe	87-92	Front	↔	
G55795	Gas Ryder	OBS.	⚡ 1.1	Honda	Prelude	Coupe	92-97	Front	↔	
G55805	Gas Ryder	OBS.	⚡ 1.1	Honda	Prelude	Coupe	92-97	Rear	↔	
				Honda	Prelude	Coupe	97-99	Rear	↔	
G55821	Gas Ryder		⚡ 1.1	Honda	Odyssey	RA1-RA5	97-99	Rear	↔	
G55875	Gas Ryder	OBS.	⚡ 1.1	Ford	Falcon, Fairlane	Futura, Fairmont (Independent Susp.)	99-03	Front	↔	
				Ford	Falcon, Fairlane	Futura, Fairmont (Without ind Susp.)	99-03	Front	↔	
G55876	Gas Ryder	OBS.	⚡ 1.1	Ford	Falcon, Fairlane	Futura, Fairmont (Independent Susp.)	99-03	Rear	↔	
G55877	Gas Ryder		⚡ 1.1	Honda	Odyssey	RA1-RA5	97-99	Front	↔	
G55910	Gas Ryder		⚡ 1.1	Honda	Ballade	150i, 160i, 180i Excl. Vtech (Mk VI) (Civic)	96-01	Rear	↔	
				Honda	Civic	Mk VI	96-01	Rear	↔	
G56102 (Cont. on next page)	Safari		⊗ 8.2	Jeep (Chrysler)	Jeep	CJ Series (Willys) (CJ5, CJ6, CJ7)	54-86	Front	↔	
				Leyland	FG 550, FG 420	Truck	68-77	Front	↔	
				Toyota	Dyna	Coaster	66-77	Front	↔	
				Bedford	CF Series	Van, Truck	70-84	Rear	↔	
				Ford	F Series	F100, F250 4X2	65-67	Rear	↔	
				Ford	F Series	F100, F250 4X2	68-69	Rear	↔	
				Ford	F Series	F350	67-81	Rear	↔	
				Ford	Husky	LDV, Panel van	86-93	Rear	↔	
				Ford	Triton 0510, 0610	Truck	85-87	Rear	↔	
				Hyundai	H100	Bakkie	96-05	Rear	↔	
				Lada	Niva	2121	87-92	Rear	↔	16
				Mitsubishi	Canter	Truck	80 on	Rear	↔	
				Mitsubishi	L300 (Delica)	Incl. Starwagon, Express	82-03	Rear	↔	
				Nissan	1 Ton Bakkie	720 4X2	80-88	Rear	↔	

G55614 - G56102



Part #	Range	Superceding Part #/Status.	Product Type	Make	Model	Derivative	Year	Position	L/R	Note # (pg 6)
G56102 <small>(From previous page)</small>	Safari		☉ 8.2	Nissan	Caball	Truck	64-78	Rear	↔	
				Toyota	Dyna	All	94 on	Rear	↔	
				Toyota	Dyna	Coaster	78-95	Rear	↔	
				Toyota	Hi-Ace	H10	69-84	Rear	↔	
				Toyota	Stallion	KF40	87-00	Rear	↔	
				Toyota	Venture	KF40	91-00	Rear	↔	
G56103	Safari		☉ 8.2	Ford	Cortina	Mk III, IV	71-78	Rear	↔	20
				Isuzu	KB (D-Max), TF Series	4X2 (Std. Height) (TF)	89-04	Rear	↔	
				Isuzu	KB (D-Max), TF Series	4X4, 4X2 (Raised Height) (TF)	89-04	Rear	↔	
				Kia	K2700	Bongo (Gen 3)	00-04	Rear	↔	
				Toyota	Hilux	4X4	79-84	Rear	↔	
G56104	Safari	OBS.	⊥ 4	Chevrolet	El Camino	Incl. El Toro	72-78	Front		
				Mazda	B Series, Drifter, Magnum	Mk II, II & IV	64-86	Front		
G56105	Safari		⊕ 5	Nissan	Patrol	Station Wagon 4X4 (Y60, Y61, Rear for Y60 only)	89-01	Front	↔	
				Ford	Ranchero	Falcon	69-76	Rear	↔	
				Mazda	B Series, Drifter, Magnum	Mk II, II & IV	64-86	Rear	↔	
				Mazda	E2000, E2700, E3000	LDV	64-83	Rear	↔	
				Mazda	E2000, E3000	Truck	67-81	Rear	↔	
				Mazda	F1000, F1300	LDV	81-86	Rear	↔	
G56106	Safari		☉ 8.1	Chevrolet	C Series	C10, C20	63-73	Front	↔	
				Chevrolet	C Series	C10, C20	74-83	Front	↔	
				Chevrolet	C Series	C30	63-73	Front	↔	
				Chevrolet	C Series	C30	74-83	Front	↔	
G56107	Safari		☉ 8.5	Chevrolet	C Series	C10, C20	63-73	Rear	↔	
G56112	Safari		☉ 8.2	Land Rover	Defender	109 WB, Series I	54-65	Front	↔	
				Land Rover	Defender	109 WB, Series II, III	65-84	Front	↔	
				Land Rover	Defender	88 WB	54-80	Front	↔	
G56113	Safari		♀ 9.1	Land Rover	Defender	109 WB, Series II, III	65-84	Rear	↔	
G56116 <small>(Cont. on next page)</small>	Safari		☉ 8.2	Bedford	J2-4	Truck	65 on	Rear	↔	
				Chevrolet	Luv	Faster	73-78	Rear	↔	
				Jeep (Chrysler)	Jeep	CJ Series (Willys) (CJ5, CJ6, CJ7)	54-86	Rear	↔	
				Ford	Courier	4X2 (Std. Susp.)	86-06	Rear	↔	
				Ford	Ranger	4X2 (Std. Susp.)	86-06	Rear	↔	
				Isuzu	KB (D-Max), TF Series	(Mk I)	78-80	Rear	↔	
				Mazda	B Series, Drifter, Magnum	4X2 Std. Susp.	86-06	Rear	↔	
				Mitsubishi	Colt Bakkie	L200 (1.6, 2.0, 2.5D 4X2)	94-98	Rear	↔	
				Mitsubishi	Colt Bakkie	L200 (4X2 Std. height)	98-07	Rear	↔	
				Mitsubishi	Triton	4X4, 4X2 Raised height	07 on	Rear	↔	
				Nissan	1 Ton Bakkie	Hardbody 4X2 (Excl. Hi Rider) (D21)	88-02	Rear	↔	
				Nissan	1 Ton Bakkie	Hardbody 4X2 Hi Rider (D21)	88-02	Rear	↔	

PARTS LISTING

Shocks & Struts

G56116



Part #	Range	Superceding Part #/Status.	Product Type	Make	Model	Derivative	Year	Position	L/R	Note # (pg 6)
G56116 (From previous page)	Safari		⊗ 8.2	Nissan	1 Ton Bakkie	Hardbody 4X4 (Incl. Sani, Patrol) (D21)	88-02	Rear	↔	
				Nissan	Sani	4X2	90-99	Rear	↔	
				Nissan	Sani	4X4	90-99	Rear	↔	
				Toyota	Dyna	Coaster	66-77	Rear	↔	
				Toyota	Stout	RK 101	61-89	Rear	↔	
G56118	Safari		⊕ 6.2	Mitsubishi	FK Series	FK 115J/K	80-86	Front	↔	
				Mitsubishi	FM Series	FM215F/L	79-86	Front	↔	
				Chevrolet	El Camino	Incl. El Toro	71-72	Rear	↔	
				Ford	F Series	F100, F250 4X2	70-81	Rear	↔	5
G56119	Safari		⊕ 5	Bedford	J2-4	Truck	65 on	Front	↔	
				Bedford	J5-6	Truck	65 on	Front	↔	
				Ford	F Series	F100, F250 4X2	65-67	Front	↔	
				Nissan	Patrol	4X4 (G160)	80-89	Front	↔	
				Nissan	Patrol	4X4 (WG60)	72-80	Front	↔	
				Nissan	Safari	Station Wagon (G160/G161) & Pick-up	82-90	Front	↔	
				Volvo	122	Amazon, B18	59-71	Front	↔	
				Jaguar	Jaguar	Mk II	61-69	Rear	↔	
G56120	Safari	G45667	⊕ 5	Ford	F Series	F250 4X4	68-77	Front	↔	
				Mazda	E2000, E2700, E3000	LDV	64-83	Front	↔	
				Mazda	E2000, E3000	Truck	67-81	Front	↔	
G56121	Safari	OBS.	⊗ 8.3	Ford	F Series	F250 4X4	68-77	Rear	↔	
G56123	Safari		⊕ 6.2	Ford	F Series	F100, F250 4X2	68-69	Front	↔	
				Ford	F Series	F100, F250 4X2	70-81	Front	↔	5
				Ford	F Series	F350	67-81	Front	↔	
G56126	Safari		⊗ 8.2	Bedford	KE, KG, KH All	Truck	64 on	Front	↔	29
				Bedford	MFR	Truck	67-71	Front	↔	29
				Bedford	VAL	Bus	66 on	Front	↔	
				Bedford	J5-6	Truck	65 on	Rear	↔	29
				Bedford	KE, KG, KH All	Truck	64 on	Rear	↔	29
				Bedford	MFR	Truck	67-71	Rear	↔	29
				Chevrolet	C Series	C30	63-73	Rear	↔	
				Isuzu	N2800 P	Truck	93 on	Rear	↔	
				Isuzu	N3000 P	Truck	87-90	Rear	↔	
				Isuzu	NKR55/99	Truck	19..	Rear	↔	
				Isuzu	TL40-50	Truck	75 on	Rear	↔	
				Isuzu	TLD44, TLD54	Truck	77-89	Rear	↔	
				Land Rover	Defender	109 WB, Series I	54-65	Rear	↔	
				Land Rover	Defender	88 WB	54-80	Rear	↔	

G56116 – G56126



Part #	Range	Superceding Part #/Status.	Product Type	Make	Model	Derivative	Year	Position	L/R	Note # (pg 6)
G56147	Safari	OBS.	⊖ 8.1	Chevrolet	C Series	C10, C20	74-83	Rear	↔	
				Chevrolet	K Series 4X4	K10, K20, K25	74-83	Rear	↔	
G56148	Safari	OBS.	⊖ 8.5	Chevrolet	C Series	C30	74-83	Rear	↔	
G56149	Safari	OBS.	⊖ 8.5	Chevrolet	K Series 4X4	K10, K20, K25	74-83	Front	↔	
G56153	Safari		⊖ 10	Ford	Cortina	Mk III, IV	71-78	Front	↔	
				Ford	Cortina	Mk IV	78-80	Front	↔	
G56154	Safari	OBS.	⊕ 5	Ford	F Series	F250 4X4	78-81	Front	↔	
G56155	Safari		⊖ 6.2	Ford	F Series	F250 4X4	78-81	Rear	↔	
G56156	Safari		⊖ 9.2	Ford	Cortina	Mk IV	78-80	Rear	↔	
G56156	Safari		⊖ 9.2	Ford	Cortina	Mk V	80-82	Rear	↔	
G56157	Safari		⊖ 9.1	Nissan	1 Ton Bakkie	620, 680, 1300, 1500	66-80	Rear	↔	
				Nissan	Caball	Truck	78-84	Rear	↔	
				Nissan	E20 (Urvan, Caravan)	Ekonowagon, Ekonovan	73-81	Rear	↔	
				Nissan	E20 (Urvan, Caravan)	Ekonowagon, Ekonovan	81-95	Rear	↔	
G56158	Safari		⊖ 6.2	Toyota	Hilux	4X4	79-84	Front	↔	
				Toyota	Hilux	4X4	84-98	Front	↔	
G56159	Safari		⊖ 9.2	Ford	Cortina	Mk V	83-86	Rear	↔	
G56160	Safari		⊖ 10	Ford	Cortina	Mk V	80-82	Front	↔	
				Ford	Cortina	Mk V	83-86	Front	↔	
G56161	Safari		⊖ 8.5	Volkswagen	Kombi	Microbus (Excl. Synchro 4X4)	80-02	Rear	↔	
G56162	Safari		⊖ 8.2	Land Rover	Defender	109, 110 WB forward control	65-83	Front	↔	
				Nissan	Caball	Truck	96 on	Rear	↔	
				Nissan	Cabstar 20, 35, 40	Truck	96 on	Rear	↔	
G56163	Safari		⊖ 9.1	Land Rover	Defender	109, 110 WB forward control	65-83	Rear	↔	
G56164	Safari		⊕ 5	Land Rover	Defender	90, 110, 130 (Incl. County & LDV)	84 on	Front	↔	
				Land Rover	Discovery	Series I	89-98	Front	↔	
				Land Rover	Range Rover	Excl. Air Susp. (Mk I)	70-96	Front	↔	
G56165	Safari		⊖ 9.1	Land Rover	Defender	90, 110, 130 (Incl. County & LDV)	84 on	Rear	↔	
				Land Rover	Discovery	Series I	89-98	Rear	↔	
				Land Rover	Range Rover	Excl. Air Susp. (Mk I)	70-96	Rear	↔	
				Land Rover	Range Rover	Air Susp. (Mk I)	92-96	Rear	↔	
G56166	Safari		⊖ 6.1	Isuzu	JCR 360, FTR	Truck	79-86	Front	↔	
				Nissan	Cabstar	Truck	84-90	Front	↔	
				Toyota	Landcruiser	FJ62, BJ60 Station Wagon	83-89	Front	↔	
G56167	Safari		⊖ 8.2	Toyota	Hilux	4X4	84-98	Rear	↔	
				Toyota	Landcruiser	HZJ70	89-99	Rear	↔	
				Toyota	Hilux	4X4, 4X2 Raised Susp.	99-05	Rear	L	
G56168	Safari		⊖ 9.1	Nissan	Safari	Station Wagon (G160/G161)	82-90	Rear	↔	
				Nissan	Tracker	4X4	80-82	Rear	↔	

PARTS LISTING

Shocks & Struts

G56169



Part #	Range	Superceding Part #/Status.	Product Type	Make	Model	Derivative	Year	Position	L/R	Note # (pg 6)
G56169	Safari	55231	⊘ 6.2	Ford	Courier	4X4, 4X2 Hi-Trail (Raised Susp.)	86-06	Front	↔	
				Ford	Ranger	4X4, 4X2 Hi-Trail (Raised Susp.)	86-06	Front	↔	
				Mazda	B Series, Drifter, Magnum	4X4, 4X2 Hi-Trail (Raised Susp.)	86-06	Front	↔	
				Tata	Telcoline	4X4, 4X2	04 on	Front	↔	
G56170	Safari		⊘ 8.5	Ford	Courier	4X4, 4X2 Hi-Trail (Raised Susp.)	86-06	Rear	↔	
				Ford	Ranger	4X4, 4X2 Hi-Trail (Raised Susp.)	86-06	Rear	↔	
				Mazda	B Series, Drifter, Magnum	4X4, 4X2 Hi-Trail (Raised Susp.)	86-06	Rear	↔	
G56171	Safari		⊘ 6.2	Nissan	1 Ton Bakkie	620, 680, 1300, 1500	66-80	Front	↔	
				Nissan	1 Ton Bakkie	720 4X2	80-88	Front	↔	
				Nissan	1 Ton Bakkie	Hardbody 4X2 Hi Rider (D21)	88-02	Front	↔	
				Nissan	1 Ton Bakkie	Hardbody 4X2 Hi Rider (D22)	02 on	Front	↔	
				Nissan	1 Ton Bakkie	Hardbody 4X4 (D22)	98 on	Front	↔	
				Nissan	1 Ton Bakkie	Hardbody 4X4 (Incl. Sani, Patrol) (D21)	88-02	Front	↔	
				Nissan	NP300	4X2 Hi Rider (D22)	08 on	Front	↔	
				Nissan	NP300	4X4 (D22)	08 on	Front	↔	
				Nissan	Sani	4X4	90-99	Front	↔	
				Nissan	Tracker	4X4	80-82	Front	↔	
G56172	Safari		⊘ 6.2	Mitsubishi	Colt Bakkie	L200 (4X2 Raised height)	98-07	Front	↔	
				Mitsubishi	Colt Bakkie	L200 (4X4)	98-07	Front	↔	
				Nissan	Sani	4X2	90-99	Front	↔	
				Toyota	Hi-Ace	LWB (H20, H30, H40)	84-93	Front	↔	
				Toyota	Hi-Ace	SWB (H20, H30, H40)	84-88	Front	↔	
				Toyota	Hi-Ace	SWB (H50)	88-93	Front	↔	
G56173	Safari		⊘ 6.2	Ford	Courier	4X2 (Std. Susp.)	86-06	Front	↔	
				Ford	Ranger	4X2 (Std. Susp.)	86-06	Front	↔	
				Isuzu	Frontier	4X4, 4X2	98-02	Front	↔	
				Isuzu	KB (D-Max), TF Series	4X4, 4X2 (Raised Height) (TF)	89-04	Front	↔	
				Isuzu	Trooper	Mk II	92-96	Front	↔	
				Mazda	B Series, Drifter, Magnum	4X2 Std. Susp.	86-06	Front	↔	
				Nissan	Terrano II	R20 LWB & SWB	99-04	Front	↔	
				Ssangyong	Musso	602TDi, E230EL, E320EL	95-06	Front	↔	
				Ssangyong	Musso Sport	DC Bakkie	04 on	Front	↔	
				Toyota	Hi-Ace	Super T (H100)	93-10	Front	↔	
G56174	Safari		⊘ 8.2	Bedford	MFR	Truck	72 on	Front	↔	
				Bedford	VAM	Bus	73-75	Front	↔	
				Bedford	MFR	Truck	72 on	Rear	↔	
				Bedford	VAM	Bus	73-75	Rear	↔	
				Nissan	Patrol	Station Wagon 4X4 (Y60, Y61, Rear for Y60 only)	89-01	Rear	↔	
				Toyota	Landcruiser	DLX, BJ75	85-99	Rear	↔	
				Toyota	Hilux	4X4, 4X2 Raised Susp.	99-05	Rear	R	

G56169 – G56174



Part #	Range	Superceding Part # /Status.	Product Type		Make	Model	Derivative	Year	Position	L/R	Note # (pg 6)
			⊖	8.2							
G56175	Safari		⊖	8.2	Toyota	Hi-Ace	LWB (H20, H30, H40)	84-93	Rear	↔	
					Toyota	Hi-Ace	Super T (H100)	93-10	Rear	↔	
					Toyota	Hi-Ace	SWB (H50)	88-93	Rear	↔	
G56176	Safari		⊖	6.2	Hyundai	H100	Bakkie	96-05	Front	↔	
					Isuzu	KB (D-Max), TF Series	(Mk I)	78-80	Front	↔	
					Isuzu	KB (D-Max), TF Series	4X4 (Mk II)	80-88	Front	↔	
					Isuzu	Trooper	Mk I	81-91	Front	↔	
G56177	Safari		⊖	8.2	Nissan	E20 (Urvan, Caravan)	Ekonowagon, Ekonovan	81-95	Front	↔	
					Toyota	Landcruiser	FJ45, BJ45	71-85	Front	↔	
					Mazda	T2000, 3000	LDV	83 on	Rear	↔	
					Mazda	T2000, T3000	Truck	81-86	Rear	↔	
G56178	Safari		⊖	4	Toyota	Hi-Ace	SWB (H20, H30, H40)	84-88	Rear	↔	
					Kia	K2700	Bongo (Gen 3)	00-04	Front	↔	
					Kia	Pregio	Bongo	00-04	Front	↔	
					Toyota	Hilux	4X2	84-98	Front	↔	
G56179	Safari		⊖	6.1	Toyota	Hilux	4X2 Std. Susp.	99-05	Front	↔	
					Nissan	Caball	Truck	96 on	Front	↔	
					Toyota	Landcruiser	DLX, BJ75	85-99	Front	↔	
G56180	Safari		⊖	5	Toyota	Landcruiser	HZJ70	89-99	Front	↔	
					Land Rover	Range Rover	Air Susp. (Mk I)	92-96	Front	↔	
G56184	Safari		⊖	8.2	Mitsubishi	Colt Bakkie	L200 (2.6, 3.0, V6 4X4, 4X2 Raised height)	94-98	Rear	↔	
					Mitsubishi	Colt Bakkie	L200 (4X2 Raised height)	98-07	Rear	↔	
					Mitsubishi	Colt Bakkie	L200 (4X4)	98-07	Rear	↔	
					Nissan	Terrano II	R50	99-04	Rear	↔	
G56185	Safari		⊖	4	Ford	Husky	LDV, Panel van	86-93	Front	↔	
					Isuzu	WFR, Relay	Fargo	80-95	Front	↔	
					Mitsubishi	Colt Bakkie	L200 (2.6, 3.0, V6 4X4, 4X2 Raised height)	94-98	Front	↔	
					Mitsubishi	L300 (Delica)	Incl. Starwagon, Express	82-03	Front	↔	
					Toyota	Stallion	KF40	87-00	Front	↔	
					Toyota	Venture	KF40	91-00	Front	↔	
G56186	Safari		⊖	8.2	Ford	Spectron	Minibus, Van	91-03	Rear	↔	
					Isuzu	KB (D-Max), TF Series	4X2 (Mk II)	80-88	Rear	↔	
					Isuzu	KB (D-Max), TF Series	4X4 (Mk II)	80-88	Rear	↔	
					Isuzu	TLD 24	Truck	77-88	Rear	↔	
					Isuzu	Trooper	Mk I	81-91	Rear	↔	
					Mazda	Marathon (Ford Husky)	Van, Bus	91-03	Rear	↔	
					Nissan	Tracker	4X4 (Incl. Sani)	82-88	Rear	↔	
					Toyota	Hilux	4X2	84-98	Rear	↔	
					Toyota	Landcruiser	FJ45, BJ45	71-85	Rear	↔	

PARTS LISTING

Shocks & Struts

G56187



Part #	Range	Superceding Part #/Status.	Product Type	Make	Model	Derivative	Year	Position	L/R	Note # (pg 6)
G56187	Safari		⊗ 8.2	Toyota	Hi-Ace	East Africa	-	Rear		
G56189	Safari		⊗ 6.2	Toyota	Hilux	4X4, 4X2 Raised Susp.	99-05	Front	↔	
G56190	Safari		⊗ 8.2	Nissan	1 Ton Bakkie	Hardbody 4X2 (Excl. Hi Rider) (D22)	02 on	Rear	↔	
				Nissan	1 Ton Bakkie	Hardbody 4X2 Hi Rider (D22)	02 on	Rear	↔	
				Nissan	1 Ton Bakkie	Hardbody 4X4 (D22)	98 on	Rear	↔	
				Nissan	NP300	4X2 (Excl. Hi Rider) (D22)	08 on	Rear	↔	
				Nissan	NP300	4X2 Hi Rider (D22)	08 on	Rear	↔	
				Nissan	NP300	4X4 (D22)	08 on	Rear	↔	
				Toyota	Hilux	4X2 Std. Susp.	99-05	Rear	↔	
G56203	Safari		⊗ 6.2	Mahindra	Scorpio	4X4 (Mk I)	06 on	Front	↔	
G56204	Safari		⊗ 8.4	Mahindra	Scorpio	4X4 (Mk I)	06 on	Rear	↔	
G56205	Safari		⊗ 3.2	Mitsubishi	Triton	4X4, 4X2 Raised height	07 on	Front	↔	
G56207	Safari		⊗ 8.2	Toyota	Hilux	4X4, 4X2 Raised Susp.	05 on	Rear	↔	
G56208	Safari		⊗ 8.2	Toyota	Hilux	4X2 Std. Susp.	05 on	Rear	↔	
G56209	Safari		⊗ 8.2	Toyota	Quantum	2.5 D-4D, 2.7 Minibus & Van Incl. Sesfikile (H200)	05 on	Rear	↔	
G56210	Safari		⊗ 8.2	Mitsubishi	Triton	4X4, 4X2 Raised height	07 on	Rear	↔	
G56211	Safari		⊗ 6.2	Toyota	Quantum	2.5 D-4D, 2.7 Minibus & Van Incl. Sesfikile (H200)	05 on	Front	↔	
G56212	Safari		⊗ 3.2	Isuzu	KB (D-Max), TF Series	4X2 (Std. Height) (P190)	04 on	Front	↔	
G56213	Safari		⊗ 8.2	Isuzu	KB (D-Max), TF Series	4X2 (Std. Height) (P190)	04 on	Rear	↔	
G56214	Safari		⊗ 6.2	Isuzu	KB (D-Max), TF Series	4X4, 4X2 (Raised Height) (P190)	04 on	Front	↔	
G56215	Safari		⊗ 8.2	Isuzu	KB (D-Max), TF Series	4X4, 4X2 (Raised Height) (P190)	04 on	Rear	↔	
G56218	Safari		⊗ 3.2	Toyota	Fortuner	4X4, 4X2 Raised Susp.	06 on	Front	↔	
				Toyota	Hilux	4X4, 4X2 Raised Susp.	05 on	Front	↔	
G56219	Safari		⊗ 6.1	Toyota	Fortuner	4X4, 4X2 Raised Susp.	06 on	Rear	↔	
G56222	Safari		⊗ 6.2	Ford	Ranger	4X4, 4X2 Hi-Trail (Raised Susp.)	07-12	Front	↔	
				Mazda	BT-50	4X4, 4X2 Raised Susp.	07-12	Front	↔	
G56223	Safari		⊗ 8.5	Ford	Ranger	4X4, 4X2 Hi-Trail (Raised Susp.)	07-12	Rear	↔	
				Mazda	BT-50	4X4, 4X2 Raised Susp.	07-12	Rear	↔	
G56224	Safari		⊗ 8.5	Opel	Corsa	Utility	04 on	Rear	↔	
G56226	Safari		⊗ 3.2	Toyota	Prado	120/125	02-09	Front	↔	
G56227	Safari		⊗ 6.1	Toyota	Prado	120/125	02-09	Rear	↔	
G56228	Safari		⊗ 8.5	Ford	Ranger	4X2 (Std. Susp.)	07-12	Rear	↔	
				Mazda	BT-50	4X2 Std. Susp.	07-12	Rear	↔	
G56230	Safari		⊗ 5	Toyota	Landcruiser	HZJ80 Station Wagon, 105	90-98	Front	↔	
G56231	Safari		⊗ 6.1	Toyota	Landcruiser	100 Series	90-98	Rear	↔	
				Toyota	Landcruiser	HZJ80 Station Wagon, 105	90-98	Rear	↔	

G56187 - G56231





G56235 - G56291

Part #	Range	Superceding Part #/Status.	Product Type	Make	Model	Derivative	Year	Position	L/R	Note # (pg 6)	
G56235	Safari		⊖	6.2	Ford	Ranger	4X2 (Std. Susp.)	07-12	Front	↔	
					Mazda	BT-50	4X2 Std. Susp.	07-12	Front	↔	
G56236	Safari		⊖	8.3	Nissan	Navara	4X4 & 4X2 (D40)	05 on	Rear	↔	
G56237	Safari		≠	3.2	Mitsubishi	Pajero	4X4 3.2 Di-D & 3.8 (Mk III)	99-07	Front	↔	
G56238	Safari		⊖	6.2	Mitsubishi	Pajero	4X4 3.2 Di-D & 3.8 (Mk III)	99-07	Rear	↔	
G56239	Safari		⊕	5	Toyota	Landcruiser	79 Series	09 on	Front	↔	
G56240	Safari		⊖	8.2	Toyota	Landcruiser	79 Series	09 on	Rear	↔	
G56241	Safari		⊖	6.2	Mitsubishi	Colt Bakkie	L200 (4X4)	98-07	Front	↔	
					Toyota	Hi-Ace	LWB (H20, H30, H40)	84-93	Front	↔	
					Toyota	Hi-Ace	SWB (H20, H30, H40)	84-88	Front	↔	
					Toyota	Hi-Ace	SWB (H50)	88-93	Front	↔	
G56244	Safari		⊖	6.2	CAM	Inyathi	Minibus	07 on	Front	↔	
G56245	Safari		⊖	8.2	CAM	Inyathi	Minibus	07 on	Rear	↔	
G56246	Safari		⊖	10	Land Rover	Discovery	Series II. 4.0 V8, 2.5TD5	98-04	Front	↔	
G56247	Safari		⊖	8.2	Land Rover	Discovery	Series II. 4.0 V8, 2.5TD5	98-04	Rear	↔	
G56249	Safari		⊖	6.2	Tata	Xenon	3.0 4X2 & 4X4	07 on	Front	↔	
G56250	Safari		⊖	8.2	Tata	Xenon	3.0 4X2 & 4X4	07 on	Rear	↔	
G56251	Safari		⊖	4	Kia	K2700	Bongo (Gen 4)	05 on	Front	↔	
G56252	Safari		⊖	8.2	Kia	K2700	Bongo (Gen 4)	05 on	Rear	↔	
G56254	Safari	NEW	⊖	8.5	Volkswagen	Amarok	Pick-Up 4X2	10 on	Rear	↔	
G56255	Safari	NEW	⊖	8.5	Volkswagen	Amarok	Pick-Up 4X4, 4X2 Raised	10 on	Rear	↔	
G56258	Safari		⊖	7.1	Fiat	Strada	3/4 Ton LDV (Mk II)	05 on	Rear	↔	
G56262	Safari		≠	3.1	Jeep (Chrysler)	Jeep	Cherokee (KJ) 2.5D, 2.8D, 3.7	01-07	Front	↔	
G56263	Safari		⊖	8.5	Jeep (Chrysler)	Jeep	Cherokee (KJ) 2.5D, 2.8D, 3.7	01-07	Rear	↔	
G56266	Safari		⊖	8.5	Kia	Sorento	2.5D, 3.5 & 3.8 (Mk I)	02-09	Rear	↔	
G56268	Safari		⊖	8.5	Mercedes-Benz	Vito	115 CDI 2.2 Bus MPV Diesel (W639)	04 on	Rear	↔	
					Mercedes-Benz	Vito	115 CDI 2.2 Cr-Cab Panel Van Diesel (W639)	04 on	Rear	↔	
G56268	Safari		⊖	8.5	Mercedes-Benz	Vito	115 CDI 2.2 Panel Van Diesel (W639)	04 on	Rear	↔	
G56276	Safari	NEW	≠	3.2	Ford	Ranger	Pick-Up 4X4, 4X2 Raised T6	12 on	Front	↔	
					Mazda	BT-50	4x4,4x2 raised Susp.	12 on	Front	↔	
G56277	Safari	NEW	⊖	8.5	Ford	Ranger	Pick-Up 4X4, 4X2 Raised T6	12 on	Rear	↔	
					Mazda	BT-50	4x4,4x2 raised Susp.	12 on	Rear	↔	
G56278	Safari	NEW	⊖	6.2	Chevrolet	Utility	Utility Pick-Up	11 on	Rear	↔	
G56281	Safari	NEW	⊖	8.2	Toyota	Vigo	(CGN25)	05 on	Rear	↔	
					Toyota	Vigo	(LAN25)	05 on	Rear	↔	
G56282	Safari	NEW	≠	3.2	Toyota	Vigo	(LAN25)	05 on	Front	↔	
G56290	Safari	NEW	≠	3.2	Ford	Ranger	Pick-Up 4X2 T6	12 on	Front	↔	
					Mazda	BT-50	4x2 Std. Susp.	12 on	Front	↔	
G56291	Safari	NEW	⊖	8.5	Ford	Ranger	Pick-Up 4X2 T6	12 on	Rear	↔	
					Mazda	BT-50	4x2 Std. Susp.	12 on	Rear	↔	

PARTS LISTING

Shocks & Struts

G56292



Part #	Range	Superceding Part #/Status.	Product Type	Make	Model	Derivative	Year	Position	L/R	Note # (pg 6)
G56292	Safari	NEW	f 3.2	Toyota	Prado	SUV 4X4 J150 (Excl. f)	09 on	Front	↔	
G56293	Safari	NEW	o 6.2	Toyota	Prado	SUV 4X4 J150 (Excl. f)	09 on	Rear	↔	
G56294	Safari	NEW	o 8.5	Hyundai	H1	Minibus	09 on	Rear	↔	
G56504	Gas Ryder	OBS.	f 1.1	Ford	Mustang	Mk III	79-84	Front	↔	
G56518	Gas Ryder		f 1.1	Suzuki	Vitara	5-Door (Excl. V6) (Mk I)	94-98	Front	↔	
G63410	Gas Ryder	OBS.	o 6.1	Ford	F Series	F150 4X4 (Quad Susp.) (Forward of front axle)	80-96	Front	↔	
G63414	Gas Ryder	OBS.	o 6.2	Ford	F Series	F150 4X4 (Excl. quad Susp.) (Rear of front axle)	80-96	Front	↔	
G63422	Gas Ryder	OBS.	o 13.2	Chevrolet	Blazer 4X4	S10 (Excl. I)	83-95	Rear	↔	
G63423	Gas Ryder	OBS.	o 8.5	Chevrolet	Blazer 4X4	S10 (Excl. I)	83-95	Front	↔	
G63424	Gas Ryder	OBS.	± 4	Jeep (Chrysler)	Jeep	Cherokee (XJ)	96-01	Front	↔	
G63424	Gas Ryder	OBS.	± 4	Jeep (Chrysler)	Jeep	Grand Cherokee (ZJ)	93-94	Front	↔	
G63424	Gas Ryder	OBS.	± 4	Jeep (Chrysler)	Jeep	Grand Cherokee (ZJ)	96-99	Front	↔	
G63425	Gas Ryder	OBS.	o 13.1	Jeep (Chrysler)	Jeep	Cherokee (XJ)	96-01	Rear		
G63461	Gas Ryder	OBS.	o 8.3	Ford	F Series	F150 4X4 (Excl. quad Susp.) (Rear of front axle)	80-96	Rear	↔	
G63461	Gas Ryder	OBS.	o 8.3	Ford	F Series	F150 4X4 (Quad Susp.) (Forward of front axle)	80-96	Rear	↔	
G63482	Gas Ryder	OBS.	♀ 9.2	Mercedes-Benz	G Class	(W460) Gelandewagen	79-90	Front	↔	
G63483	Gas Ryder	OBS.	o 6.2	Mercedes-Benz	G Class	(W460) Gelandewagen	79-90	Rear	↔	
G63508	Gas Ryder	OBS.	o 6.1	Daihatsu	Feroza	F300	97-99	Rear	↔	
G63612	Gas Ryder	OBS.	o 6.2	Daihatsu	Feroza	F300	97-99	Front	↔	
G63626	Gas Ryder	OBS.	o 8.3	Jeep (Chrysler)	Jeep	Grand Cherokee (ZJ)	93-94	Rear	↔	
G63626	Gas Ryder	OBS.	o 8.3	Mercedes-Benz	G Class	(W463) Gelandewagen	90 on	Rear	↔	
G63678	Gas Ryder	OBS.	± 4	Ford	Explorer	Mk II	95-01	Front	↔	
G63679	Gas Ryder	OBS.	o 13.2	Ford	Explorer	Mk II	95-01	Rear	↔	
G63683	Gas Ryder	OBS.	o 8.3	Jeep (Chrysler)	Jeep	Grand Cherokee (ZJ)	96-99	Rear	↔	
G63690	Gas Ryder		o 8.5	Chrysler	Voyager	Gen III (Incl Grande Voyager) (Excl. I)	96-00	Rear	↔	
G63690	Gas Ryder		o 8.5	Chrysler	Voyager	Gen IV (Incl Grande Voyager) (Excl. I)	01-07	Rear	↔	
G63694	Gas Ryder	OBS.	♀ 9.2	Land Rover	Range Rover	Air Susp. (Mk I)	92-96	Rear		
G63720	Gas Ryder		o 6.2	Kia	Sportage	2.0, 2.0D (Mk I)	93-04	Rear	↔	
G63721	Gas Ryder		± 4	Jeep (Chrysler)	Jeep	Wrangler 4X4 (TJ)	96-06	Front	↔	
G63722	Gas Ryder		o 13.2	Jeep (Chrysler)	Jeep	Wrangler 4X4 (TJ)	96-06	Rear	↔	
G63737	Gas Ryder	OBS.	o 6.2	Isuzu	Trooper	Mk II	96-03	Front	↔	
G63738	Gas Ryder	OBS.	o 8.5	Isuzu	Trooper	Mk II	96-03	Rear	↔	
G63799	Gas Ryder		± 5	Suzuki	Vitara	5-Door (Excl. V6) (Mk I)	94-98	Rear	↔	
G63914	Gas Ryder	OBS.	o 6.2	Chevrolet	Lumina	APV	90-95	Rear	↔	
G63914	Gas Ryder	OBS.	o 6.2	Chevrolet	Lumina	Van	90-95	Rear	↔	
G63920	Gas Ryder	OBS.	± 5	Toyota	Previa	(2.7, 2.5 D-4D) (Bus, LWB Panel Van) (H200)	90-99	Rear	↔	

G56292 - G63920



Part #	Range	Superceding Part #/Status.	Product Type	Make	Model	Derivative	Year	Position	L/R	Note # (pg 6)
G63935	Gas Ryder	OBS.	⊕ 6.2	Daihatsu	Rocky	Mk II	97-02	Front	↔	
G63936	Gas Ryder	OBS.	⊕ 6.2	Daihatsu	Rocky	Mk II	97-02	Rear	↔	
G63940	Gas Ryder		⊕ 6.1	Toyota	Rav4	Sealed struts (XA10)	98-00	Rear	↔	
				Toyota	Rav4	Serviceable front struts (XA10) Mk I	95-98	Rear	↔	
GS46006	Safari HDP		⚡ 3.2	Mitsubishi	Pajero	3.0, 3.8, 3.2 Di-D (Mk IV NS, SWB & LWB)	07 on	Front	↔	
				Mitsubishi	Pajero	4X4 3.2 Di-D & 3.8 (Mk III)	99-07	Front	↔	
GS46007	Safari HDP		⚡ 3.2	Toyota	Fortuner	4X4, 4X2 Raised Susp.	06 on	Front	↔	33
				Toyota	Hilux	4X4, 4X2 Raised Susp.	05 on	Front	↔	33
				Toyota	Prado	120/125	02-09	Front	↔	33
GS46008	Safari HDP		⚡ 3.2	Toyota	4-Runner/ Hilux Surf	VZN185	95-02	Front	↔	
				Toyota	Prado	Land Cruiser 90 SWB	96-02	Front	↔	
				Toyota	Prado	Land Cruiser 95 LWB	96-02	Front	↔	
GS46009	Safari HDP		⚡ 3.2	Mitsubishi	Triton	4X4, 4X2 Raised height	07 on	Front	↔	
GS46010	Safari HDP		⚡ 3.2	Nissan	Navara	4X4 & 4X2 (D40)	05-09	Front	↔	
				Nissan	Pathfinder	2.5 DCi, 4.0 (Mk III R51 Series)	05-12	Front	↔	
GS46011	Safari HDP		⚡ 3.1	Jeep (Chrysler)	Jeep	Cherokee (KJ) 2.5D, 2.8D, 3.7	01-07	Front	↔	
GS46012	Safari HDP	NEW	⚡ 3.2	Toyota	FJ Cruiser	FJ Cruiser	11 on	Front	↔	
				Toyota	Prado	SUV 4X4 J150 (Excl. ⚡)	09 on	Front	↔	
GS46013	Safari HDP	NEW	⚡ 3.2	Ford	Ranger	Pick-Up 4X4, 4X2 Raised T6	12 on	Front	↔	
				Mazda	BT-50	4x4, 4x2 raised suspension	12 on	Front	↔	
GS46014	Safari HDP	NEW	⚡ 3.2	Isuzu	KB (D-Max), TF Series	KB (D-Max), TF Series 4X4, 4X2 (Raised Height) (Mk VI)	13 on	Front	↔	
GS56220	Safari HDP		⊕ 6.2	Mitsubishi	Colt Bakkie	L200 (4X2 Raised height)	98-07	Front	↔	
				Mitsubishi	Colt Bakkie	L200 (4X4)	98-07	Front	↔	
				Mitsubishi	Pajero	V Series (Mk II)	91-99	Front	↔	
GS56221	Safari HDP		⊕ 6.2	Nissan	1 Ton Bakkie	Hardbody 4X2 Hi Rider (D22)	02 on	Front	↔	
				Nissan	1 Ton Bakkie	Hardbody 4X4 (D22)	98 on	Front	↔	
				Nissan	NP300	4X4 (D22)	08 on	Front	↔	
GS56225	Safari HDP		⊕ 6.2	Isuzu	KB (D-Max), TF Series	4X4, 4X2 (Raised Height) (P190)	04 on	Front	↔	
				Isuzu	KB (D-Max), TF Series	4X4, 4X2 (Raised Height) (TF)	89-04	Front	↔	
GS56232	Safari HDP		⊕ 6.2	Toyota	Hilux	4X4, 4X2 Raised Susp.	99-05	Front	↔	
GS56233	Safari HDP		⊕ 6.2	Ford	Courier	4X4, 4X2 Hi-Trail (Raised Susp.)	86-06	Front	↔	
				Ford	Ranger	4X4, 4X2 Hi-Trail (Raised Susp.)	86-06	Front	↔	
				Ford	Ranger	4X4, 4X2 Hi-Trail (Raised Susp.)	07-12	Front	↔	
				Mazda	B Series, Drifter, Magnum	4X4, 4X2 Hi-Trail (Raised Susp.)	86-06	Front	↔	
				Mazda	BT-50	4X4, 4X2 Raised Susp.	07-12	Front	↔	
GS56234	Safari HDP		⊕ 4	Mitsubishi	Colt Bakkie	L200 (2.6, 3.0, V6 4X4, 4X2 Raised height)	94-98	Front	↔	
GS56259	Safari HDP		⊕ 8.2	Nissan	Navara	4X4 & 4X2 (D40)	05-09	Rear	↔	
GS56260	Safari HDP		⊕ 8.5	Nissan	Pathfinder	2.5 DCi, 4.0 (Mk III R51 Series)	05-12	Rear	↔	

PARTS LISTING

Shocks & Struts

GS56261



Part #	Range	Superceding Part #/Status.	Product Type	Make	Model	Derivative	Year	Position	L/R	Note # (pg 6)
GS56261	Safari HDP		⊖ 13.1	Jeep (Chrysler)	Jeep	Cherokee (XJ)	96-01	Rear	↔	
GS56264	Safari HDP		⊖ 6.2	Mahindra	Scorpio	4X4, 4X2 Raised. (Mk I) 2.2, 2.4D	06 on	Front	↔	
GS56265	Safari HDP		⊖ 8.4	Mahindra	Scorpio	4X4, 4X2 Raised. (Mk I) 2.2, 2.4D	06 on	Rear	↔	
GS56267	Safari HDP		⊖ 8.5	Jeep (Chrysler)	Jeep	Cherokee (KJ) 2.5D, 2.8D, 3.7	01-07	Rear	↔	
GS56283	Safari HDP	NEW	⊖ 6.2	Suzuki	Jimny	(Gen 3)	98 on	Front	↔	
GS56284	Safari HDP	NEW	⊖ 8.5	Suzuki	Jimny	(Gen 3)	98 on	Rear	↔	
GS56288	Safari HDP	NEW	⊖ 6.2	Jeep (Chrysler)	Jeep	Wrangler 4X4 (JK)	07-11	Front	↔	
GS56289	Safari HDP	NEW	⊖ 13.2	Jeep (Chrysler)	Jeep	Wrangler 4X4 (JK)	07-11	Rear	↔	
GS70760	Safari HDP	NEW	† 3.3	Volkswagen	Amarok	Pick-Up 4X4, 4X2 Raised	10 on	Front	↔	
GS78000	Safari HDP		⊖ 6.2	Toyota	Hilux	4X4	84-98	Front	↔	
GS78001	Safari HDP		⊖ 8.2	Toyota	Hilux	4X4	84-98	Rear	↔	
GS78002	Safari HDP		† 5	Toyota	Landcruiser	70/75 SW	07 on	Front	↔	
GS78002	Safari HDP		† 5	Toyota	Landcruiser	Pick-up	99 on	Front	↔	
GS78003	Safari HDP		⊖ 8.2	Mitsubishi	Colt Bakkie	L200 (4X2 Raised height)	98-07	Rear	↔	
GS78003	Safari HDP		⊖ 8.2	Mitsubishi	Colt Bakkie	L200 (4X4)	98-07	Rear	↔	
GS78004	Safari HDP		⊖ 8.2	Toyota	Hilux	4X4, 4X2 Raised Susp.	99-05	Rear	L	
GS78005	Safari HDP		⊖ 8.2	Toyota	Hilux	4X4, 4X2 Raised Susp.	99-05	Rear	R	
GS78006	Safari HDP		⊖ 8.2	Isuzu	KB (D-Max), TF Series	4X4, 4X2 (Raised Height) (P190)	04 on	Rear	↔	
				Isuzu	KB (D-Max), TF Series	4X4, 4X2 (Raised Height) (TF)	89-04	Rear	↔	
GS78007	Safari HDP		† 5	Land Rover	Defender	90, 110, 130 (Incl. County & LDV)	84 on	Front	↔	
				Land Rover	Discovery	Series I	89-98	Front	↔	
				Land Rover	Range Rover	Excl. Air Susp. (Mk I)	70-96	Front	↔	
GS78008	Safari HDP		⊖ 9.1	Land Rover	Defender	90, 110, 130 (Incl. County & LDV)	84 on	Rear	↔	
				Land Rover	Discovery	Series I	89-98	Rear	↔	
				Land Rover	Range Rover	Excl. Air Susp. (Mk I)	70-96	Rear	↔	
GS78009	Safari HDP		⊖ 8.2	Toyota	Hilux	4X4, 4X2 Raised Susp.	05 on	Rear	↔	
GS78010	Safari HDP		⊖ 6.1	Toyota	Fortuner	4X4, 4X2 Raised Susp.	06 on	Rear	↔	
GS78011	Safari HDP		† 5	Toyota	Landcruiser	80	90-98	Front	↔	
				Toyota	Landcruiser	105	99-07	Front	↔	
GS78012	Safari HDP		⊖ 6.1	Toyota	Landcruiser	80	90-98	Rear	↔	
				Toyota	Landcruiser	105	99-07	Rear	↔	
GS78013	Safari HDP		⊖ 8.5	Toyota	Landcruiser	70/75 SW	07 on	Rear	↔	
				Toyota	Landcruiser	Pick-up	99 on	Rear	↔	
GS78014	Safari HDP		⊖ 8.5	Ford	Courier	4X4, 4X2 Hi-Trail (Raised Susp.)	86-06	Rear	↔	
				Ford	Ranger	4X4, 4X2 Hi-Trail (Raised Susp.)	86-06	Rear	↔	
				Ford	Ranger	4X4, 4X2 Hi-Trail (Raised Susp.)	07-12	Rear	↔	
				Mazda	B Series, Drifter, Magnum	4X4, 4X2 Hi-Trail (Raised Susp.)	86-06	Rear	↔	
				Mazda	BT-50	4X4, 4X2 Raised Susp.	07-12	Rear	↔	

GS56261 – GS78014



PARTS FINDER – SHOCKS, STRUTS & CARTRIDGES

The Parts Finder is designed to simplify the selection of an alternative manufacturer's part by listing other part numbers in alpha numeric sequence and not by manufacturer.

Where a manufacturer's part number has various Gabriel part numbers that may be used, these are listed as alternatives.

The Gabriel Europe & Gabriel India manufacturing numbers are also listed with the part numbers given as alternatives.

Please note that any reference to brands, trademarks or Manufacturer's part numbers is for reference and identification purposes only.



Part #	Manufacturer	Gabriel		Model/Year/Side
		Primary	Alternative	
5794	Monroe	36866		
5909	Monroe	62011		
10014	Monroe	35831		
10049	Monroe	55868		
10053	Monroe	G35279		
11003	Monroe	44221		
11022	Monroe	70580		Front Right
11023	Monroe	70579		Front Left
11036	Monroe	35824		
11039	Monroe	35847		
11040	Monroe	35832		
11050	Monroe	55858		
11055	Monroe	55806		
11069	Monroe	55807		
11085	Monroe	35833		
11166	Monroe	55865		
11272	Monroe	70512		
11377	Monroe	G35300		Front Right
11378	Monroe	G35295		Front Left
11519	Monroe	G35101		
11580	Monroe	55845		
11654	Monroe	44502		
11743	Monroe	35117		
11779	Monroe	35944		Front Right
11780	Monroe	35943		Front Left
11781	Monroe	35946		Rear Right
11782	Monroe	35945		Rear Left
12644	Monroe	70520		Front Right
16072	Monroe	55810		
16077	Monroe	35842		
16211	Monroe	35816		
16214	Monroe	G45399		
16242	Monroe	70511		
16244	Monroe	70519		Front Left
16244	Monroe	55896		
16245	Monroe	70520		Front Right
16245	Monroe	55897		
16248	Monroe	70545		Rear Right
16248	Monroe	70521		Rear Left
16248	Monroe	55895		
16248	Monroe	55901		
16249	Monroe	70544		Rear Left
16249	Monroe	70522		Rear Right
16249	Monroe	55894		

Part #	Manufacturer	Gabriel		Model/Year/Side
		Primary	Alternative	
16249	Monroe	55902		
16264	Monroe	55881		
16269	Monroe	55863		
16275	Monroe	G35301		Front Right
16276	Monroe	G35296		Front Left
16297	Monroe	70500		Front Left
16298	Monroe	70501		Front Right
16304	Monroe	G35299		Front Right
16305	Monroe	G35284		Front Left
16312	Monroe	35952		Front Right
16313	Monroe	35951		Front Left
16318	Monroe	55825		
16320	Monroe	55891		Rear Right
16321	Monroe	55890		Rear Left
16329	Monroe	70504		
16331	Monroe	70526		Rear Right
16332	Monroe	70525		Rear Left
16343	Monroe	70537		Front Right
16344	Monroe	70536		Front Left
16345	Monroe	55889		Front Right
16346	Monroe	55888		Front Left
16347	Monroe	55890		Rear Left
16347	Monroe	55891		Rear Right
16352	Monroe	70519		Front Left
16356	Monroe	G35214		
16361	Monroe	70551		Front Right
16362	Monroe	70550		Front Left
16363	Monroe	70549		Front Right
16364	Monroe	70548		Front Left
16383	Monroe	70568		Front Right
16384	Monroe	70567		Front Left
16385	Monroe	70568		Front Right
16386	Monroe	70567		Front Left
16387	Monroe	G35421		
16440	Monroe	70540		Front Right
16440	Monroe	G35338		Front Left
16441	Monroe	70539		Front Left
16441	Monroe	G35337		Front Right
16508	Monroe	35836		
16511	Monroe	55815		
16517	Monroe	35836		
16541	Monroe	55841		
16555	Monroe	G55592		
16583	Monroe	55834		Front Left

PARTS FINDER

Shocks, Struts & Cartridges

16639 – 43110



Part #	Manufacturer	Gabriel		Model/Year/Side
		Primary	Alternative	
16639	Monroe	55834		Front Left
16640	Monroe	55835		Front Right
16657	Monroe	EG35115		
16660	Monroe	55847		Front Right
16662	Monroe	55849		Rear Right
16681	Monroe	44227		
16688	Monroe	G35225		Front Right
16689	Monroe	G35220		Front Left
16734	Monroe	G55673		
16749	Monroe	70539		Front Left
16776	Monroe	G35214		
19501	Monroe	42942		
21608	Monroe	61241		
21659	Monroe	61285		
22045	Monroe	19021		
22651	Monroe	G45466		
22709	Monroe	36867		
22709	Monroe	36867		
23248	Monroe	36850		
23267	Monroe	G45666		
23436	Monroe	61248		
23442	Monroe	G45824		
23442	Monroe	69689		
23728	Monroe	69068		
23729	Monroe	69067		
23747	Monroe	69075		
23760	Monroe	69076		
23760	Monroe	69067		
23828	Monroe	G51269		
23829	Monroe	G51269		
23858	Monroe	69084		
23859	Monroe	G55910		
23869	Monroe	G51214		
23871	Monroe	G55821		
23875	Monroe	G55877		
23895	Monroe	G51214		
23896	Monroe	69989		
23896	Monroe	69425		
23904	Monroe	69422		
23935	Monroe	G51275		
23951	Monroe	G51238		
23957	Monroe	69924		
23965	Monroe	61270		
23967	Monroe	69538		

Part #	Manufacturer	Gabriel		Model/Year/Side
		Primary	Alternative	
23969	Monroe	61295		
23970	Monroe	G51298		
23972	Monroe	62001		
23972	Monroe	62001		
23974	Monroe	70530		Rear Left
23974	Monroe	61284		
23979	Monroe	69506		
23982	Monroe	62019		
23983	Monroe	62003		
23988	Monroe	G45894		
23989	Monroe	G45894		
23990	Monroe	62010		
23992	Monroe	G45892		
23992	Monroe	G45892		
25504	Monroe	61286		
26327	Monroe	69072		
26340	Monroe	69072		
26624	Monroe	62352		
26635	Monroe	62353		
33917	KYB	70588		Front Right
34905	Monroe	G56102		
34963	Monroe	G45051		
34963	Monroe	G45870		
34963	Monroe	G56174		
36033	Monroe	G556261		
37026	Monroe	G63721		
37027	Monroe	G556261		
37083	Monroe	G578025		
37122	Monroe	G56169		
37135	Monroe	G63722		
37203	Monroe	G56263		
42021	Monroe	G45841		
42041	Monroe	69965		
42060	Monroe	69922		
43001	Monroe	61201		
43013	Monroe	69066		
43027	Monroe	69677		
43050	Monroe	36855		
43070	Monroe	69744		
43082	Monroe	61253		
43095	Monroe	69927		
43109	Monroe	69446		
43110	Monroe	69401		
43110	Monroe	69446		



43125 – 333025

PARTS FINDER

Shocks, Struts & Cartridges

Part #	Manufacturer	Gabriel		Model/Year/Side
		Primary	Alternative	
43125	Monroe	61299		
44516	KYB	G55600		
52003	Monroe	36854		
53005	Monroe	55208		
53007	Monroe	61230		
55016	Monroe	61248		
55019	Monroe	69928		
65107	Monroe	76009		
65107	Monroe	77012		
65139	Monroe	85320		
65490	Monroe	85319		
66618	Monroe	76110		
66626	Monroe	55232		
66626	Monroe	55234		
66653	Monroe	76108		
66886	Monroe	76007		
71326	Monroe	69099		
71326	Monroe	69100		
71380	Monroe	69104		
71380	Monroe	69104		
71406	Monroe	70522		Rear Right
71407	Monroe	70521		Rear Left
71417	Monroe	69099		
71435	Monroe	70554		Front Left
71436	Monroe	70555		Front Right
71577	Monroe	G56263		
71578	Monroe	55899		Rear Left
71579	Monroe	55900		Rear Right
71580	Monroe	55898		
71599	Monroe	69099		
71837	Monroe	G55600		
71959	Monroe	G55679		
71960	Monroe	G55680		
71964	Monroe	G55697		
72170	Monroe	70518		Front Right
72171	Monroe	70517		Front Left
72288	Monroe	70609		
72288	Monroe	70609		Front Right
72289	Monroe	70608		
72289	Monroe	70608		Front Left
72295	Monroe	35941		Front Right
72296	Monroe	35941		Front Left
72296	Monroe	35942		Front Left
74028	Monroe	77018		

Part #	Manufacturer	Gabriel		Model/Year/Side
		Primary	Alternative	
74074	Monroe	55233		
74076	Monroe	76016		
74076	Monroe	76043		
74081	Monroe	76204		
74425	Monroe	85724		
234901	KYB	G55680		
234902	KYB	G55679		
235627	KYB	55898		
235628	KYB	55900		Rear Right
235629	KYB	55899		Rear Left
243025	KYB	G56210		
243033	KYB	36865		
323041	KYB	70519		Front Left
323041	KYB	70520		Front Right
331017	KYB	G56262	GS46011	
331017	KYB	G56263		
331900	KYB	G51217		
332007	KYB	35847		
332009	KYB	55804		Rear Right
332010	KYB	55804		Rear Left
332011	KYB	55813		Front Right
332011	KYB	G45399		
332012	KYB	55813		Front Left
332026	KYB	G45859		
332027	KYB	55817		
332029	KYB	35847		
332054	KYB	55865		
332057	KYB	55856		Rear Right
332081	KYB	55868		
332088	KYB	55863		
332094	KYB	55870		
332095	KYB	55870		
332100	KYB	G35300		Front Right
332101	KYB	G35295		Front Left
332108	KYB	55870		Rear Right
332109	KYB	55870		Rear Left
332116	KYB	55838		Front Left
332117	KYB	55839		Front Right
332500	KYB	70570		Front Right
332501	KYB	70569		Front Left
333007	KYB	35832		
333021	KYB	35830		
333022	KYB	35831		
333025	KYB	35832		

Be safe. Be sure.

PARTS FINDER

Shocks, Struts & Cartridges

333027 – 333756



Part #	Manufacturer	Gabriel		Model/Year/Side
		Primary	Alternative	
333027	KYB	55807		
333028	KYB	55806		
333030	KYB	55810		
333031	KYB	55810		
333051	KYB	55819		Rear Right
333052	KYB	55819		Rear Left
333090	KYB	55855		Rear Left
333114	KYB	55856		Rear Right
333115	KYB	55812		
333118	KYB	55818		Front Right
333119	KYB	55818		Front Left
333126	KYB	55825		Front Right
333127	KYB	55825		Front Left
333179	KYB	55825		
333205	KYB	70520		Front Right
333206	KYB	70519		Front Left
333211	KYB	55869		
333212	KYB	55869		
333236	KYB	55861		Front Right
333237	KYB	55861		Front Left
333244	KYB	70535		Front Right
333245	KYB	70534		Front Left
333246	KYB	70533		Rear Right
333247	KYB	70532		Rear Left
333256	KYB	35952		Front Right
333257	KYB	35951		Front Left
333264	KYB	70526		Rear Right
333265	KYB	70525		Rear Left
333274	KYB	55825		
333276	KYB	55890		Rear Left
333276	KYB	55891		Rear Right
333298	KYB	35951		
333299	KYB	35952		
333308	KYB	70500		Front Left
333309	KYB	70501		Front Right
333314	KYB	70537		Front Right
333315	KYB	70536		Front Left
333331	KYB	70610		Front Left
333332	KYB	70611		Front Right
333338	KYB	55892		Front Left
333339	KYB	55893		Front Right
333350	KYB	55889		Front Right
333351	KYB	55888		Front Left
333366	KYB	70551		Front Right

Part #	Manufacturer	Gabriel		Model/Year/Side
		Primary	Alternative	
333367	KYB	70550		Front Left
333383	KYB	70568		Front Right
333384	KYB	70567		Front Left
333390	KYB	70590		Front Right
333391	KYB	70589		Front Left
333400	KYB	70568		Front Right
333401	KYB	70567		Front Left
333410	KYB	70611		Front Right
333411	KYB	70610		Front Left
333417	KYB	35942		Front Right
333418	KYB	35941		Front Left
333419	KYB	70566		Rear Right
333420	KYB	70565		Rear Left
333453	KYB	70580		
333453	KYB	70580		Front Right
333454	KYB	70579		
333454	KYB	70579		Front Left
333464	KYB	35927		
333464	KYB	70510		
333499	KYB	55833		
334621	KYB	70548		Front Right
334622	KYB	70548		Front Left
333500	KYB	70522		Rear Right
333501	KYB	70521		Rear Left
333504	KYB	70531		Rear Right
333505	KYB	70530		Rear Left
333506	KYB	70549		Front Right
333507	KYB	70548		Front Left
333614	KYB	G35365		
333709	KYB	G35301		Front Right
333710	KYB	G35296		Front Left
333712	KYB	55811		
333713	KYB	55881		
333718	KYB	G35421		
333721	KYB	70576		Front Right
333722	KYB	70575		Front Left
333727	KYB	G35193		Front Left
333728	KYB	G35199		Front Right
333729	KYB	G35348		Front Right
333729	KYB	70539		Front Left
333730	KYB	G35347		Front Left
333755	KYB	70504		
333755	KYB	70527		
333756	KYB	55858		



333756 – 334831

PARTS FINDER

Shocks, Struts & Cartridges

Part #	Manufacturer	Gabriel		Model/Year/Side
		Primary	Alternative	
333756	KYB	70527		
333757	KYB	G35369		Front Left
333758	KYB	G35369		
333758	KYB	G35370		Front Right
333759	KYB	G35326		
333760	KYB	G35326		
333802	KYB	35816		
333831	KYB	55858		
333832	KYB	35842		
333833	KYB	55854		
333841	KYB	35816		
333870	KYB	G35279		
333917	KYB	55835		Front Right
333918	KYB	55834		Front Left
333918	KYB	70587		Front Left
333930	KYB	G35412		Front Left
333942	KYB	G35214		
333944	KYB	G35365		
333946	KYB	70504		
334017	KYB	55815		
334056	KYB	55840		
334082	KYB	55844		Front Right
334083	KYB	55843		Front Left
334084	KYB	55845		
334088	KYB	G55592		
334139	KYB	G56518		Front Left
334139	KYB	G63799		
334139	KYB	G63663		
334141	KYB	G55673		
334154	KYB	G35225		Front Right
334155	KYB	G35220		Front Left
334170	KYB	55847		Front Right
334171	KYB	55846		Front Left
334178	KYB	55863		Rear Right
334179	KYB	55863		Rear Left
334188	KYB	G55697		
334231	KYB	35944		Front Right
334231	KYB	35944		
334232	KYB	35943		Front Left
334232	KYB	35943		
334233	KYB	35946		Rear Right
334233	KYB	35946		
334234	KYB	35945		Rear Left
334234	KYB	35945		

Part #	Manufacturer	Gabriel		Model/Year/Side
		Primary	Alternative	
334241	KYB	70523		Front Left
334241	KYB	70524		Front Right
334251	KYB	70524		Front Right
334252	KYB	70523		Front Left
334354	KYB	G35225		Front Right
334360	KYB	70557		Front Right
334361	KYB	70556		Front Left
334362	KYB	70559		Rear Right
334363	KYB	70558		Rear Left
334376	KYB	55893		Front Right
334376	KYB	55893		
334377	KYB	55892		Front Left
334377	KYB	55892		
334472	KYB	70609		
334472	KYB	70609		Front Right
334473	KYB	70608		
334473	KYB	70608		Front Left
334478	KYB	55849		Rear Right
334479	KYB	55848		Rear Left
334500	KYB	70555		Front Right
334501	KYB	70554		Front Left
334602	KYB	G35290		Front Right
334602	KYB	G35289		Front Left
334603	KYB	G35289		Front Left
334604	KYB	EG35047		Front Right
334605	KYB	EG35046		Front Left
334607	KYB	70505		
334608	KYB	70505		
334615	KYB	70508		Front Left
334620	KYB	70538		
334625	KYB	70577		Front Left
334626	KYB	70578		Front Right
334627	KYB	70578		Right
334628	KYB	70577		Left
334660	KYB	70511		
334700	KYB	70593		Front Right
334701	KYB	70592		Front Left
334801	KYB	G35101		
334807	KYB	35117		
334810	KYB	55841		
334812	KYB	55872		
334815	KYB	70702		
334816	KYB	70701		
334831	KYB	G35451		

PARTS FINDER

Shocks, Struts & Cartridges

334835 – 341817



Part #	Manufacturer	Gabriel		Model/Year/Side
		Primary	Alternative	
334835	KYB	70503		
334847	KYB	61918		
334903	KYB	EG35115		
334903	KYB	EG35115		
334913	KYB	G35216		
334917	KYB	G35160		
334921	KYB	G35189		
334922	KYB	69922		
334925	KYB	70588		Front Right
334926	KYB	70587		Front Left
334939	KYB	70509		Front Right
334946	KYB	70508		
334947	KYB	G35190		
335032	KYB	G56173		
335042	KYB	70518		Front Right
335043	KYB	70517		Front Left
335607	KYB	70591		
335808	KYB	70546		
335811	KYB	G35228		
335812	KYB	G35228		
335924	KYB	70542		Front Left
335924	KYB	70543		Front Right
335924	KYB	70543		
335925	KYB	70542		Front Left
335925	KYB	70542		
335925	KYB	70543		Front Right
339029	KYB	70564		Front Right
339030	KYB	70563		Front Left
339086	KYB	55887		Front Right
339087	KYB	55886		Front Left
339702	KYB	70631		Front Left
339702	KYB	70632		Front Right
339703	KYB	70631		Front Left
339727	KYB	70509		
339728	KYB	70508		Front Left
340023	KYB	G56222		
341001	KYB	36760		
341001	KYB	36760		
341002	KYB	61201		
341031	KYB	69074		
341043	KYB	62351		
341050	KYB	69067		
341080	KYB	62352		
341081	KYB	62353		

Part #	Manufacturer	Gabriel		Model/Year/Side
		Primary	Alternative	
341085	KYB	69075		
341088	KYB	55820		
341094	KYB	69076		
341120	KYB	G51213		
341133	KYB	69072		
341144	KYB	62352		
341147	KYB	G51059		
341166	KYB	69965		
341189	KYB	69921		
341190	KYB	G51227		
341192	KYB	G51186		
341198	KYB	G55910		
341204	KYB	G51269		
341227	KYB	G51214		
341234	KYB	69084		
341239	KYB	69914		
341247	KYB	G56178		
341249	KYB	69401		
341249	KYB	69446		
341250	KYB	69446		
341251	KYB	G56237		
341260	KYB	G51255		
341261	KYB	G51256		
341279	KYB	69093		
341280	KYB	69099		
341280	KYB	69099		
341281	KYB	69100		
341282	KYB	69093		
341311	KYB	G51298		
341322	KYB	69092		
341322	KYB	69103		
341338	KYB	69092		
341338	KYB	69092		
341340	KYB	G56226		
341355	KYB	G56212		
341372	KYB	G56218		
341372	KYB	G56218		
341395	KYB	G51227		
341397	KYB	G45889		Front Right
341398	KYB	G45888		Front Left
341463	KYB	69104		
341684	KYB	46003	G546010	
341814	KYB	61298		
341817	KYB	G51275		



341821 – 343366

PARTS FINDER

Shocks, Struts & Cartridges

Part #	Manufacturer	Gabriel		Model/Year/Side
		Primary	Alternative	
341821	KYB	69106		
341840	KYB	G51216		
341842	KYB	69087		
341842	KYB	69087		
341845	KYB	69101		
341846	KYB	83367		
341904	KYB	G51101		
341910	KYB	G51238		
341911	KYB	G51239		
341952	KYB	G51089		
341953	KYB	69082		
342001	KYB	19021		
342009	KYB	19022		
343005	KYB	G45489		
343007	KYB	G45399		
343017	KYB	82608		
343022	KYB	36850		
343036	KYB	G45841		
343044	KYB	61230		
343046	KYB	36854		
343047	KYB	G45874		
343087	KYB	G45419		
343097	KYB	G45893		
343098	KYB	G45006		
343099	KYB	61252		
343116	KYB	G45078		
343127	KYB	G45255		
343150	KYB	61200		
343152	KYB	36851		
343154	KYB	G45466		
343157	KYB	G45534		
343169	KYB	69050		
343169	KYB	69089		
343181	KYB	G45417		
343183	KYB	G45824		
343183	KYB	69689		
343185	KYB	G45122		
343187	KYB	G45860		
343189	KYB	61241		
343191	KYB	69068		
343195	KYB	G56158		
343199	KYB	G45870		
343199	KYB	G56186		
343200	KYB	G56102		

Part #	Manufacturer	Gabriel		Model/Year/Side
		Primary	Alternative	
343208	KYB	G56171		
343214	KYB	G56116		
343215	KYB	G45871		
343215	KYB	G56173		
343216	KYB	69460		
343228	KYB	G45878		
343231	KYB	36855		
343246	KYB	G56167		Rear Left
343251	KYB	G45006		
343251	KYB	G56116		
343252	KYB	G56116	G45871	
343253	KYB	G56167		
343253	KYB	G578001		
343255	KYB	61248		
343265	KYB	61256		
343271	KYB	G51023		
343272	KYB	G63940		
343272	KYB	G63940		
343274	KYB	69081		
343281	KYB	69946		
343287	KYB	G45901		
343288	KYB	G45902		
343289	KYB	69989		
343290	KYB	69422		
343292	KYB	G56116		
343304	KYB	69431		
343308	KYB	G56224		
343308	KYB	69415		
343319	KYB	69924		
343326	KYB	G56116		
343328	KYB	G45879		
343330	KYB	69948		
343334	KYB	G45844		
343336	KYB	G45869		
343337	KYB	G56186	G45870	
343338	KYB	G56171		
343342	KYB	G56172	G45869	
343343	KYB	G56116		
343344	KYB	G45008		
343346	KYB	G56167		
343348	KYB	61262		
343350	KYB	61256		
343352	KYB	61248		
343353	KYB	61295		
343355	KYB	G56103		
343366	KYB	G56171		

PARTS FINDER

Shocks, Struts & Cartridges

343367 – 344800



Part #	Manufacturer	Gabriel		Model/Year/Side
		Primary	Alternative	
343367	KYB	G56116	G45872	
343367	KYB	G56190		
343369	KYB	G56171		
343388	KYB	G556260		
343398	KYB	61285		
343405	KYB	62000		
343412	KYB	G45892		
343412	KYB	G45892		
343413	KYB	G45894		
343413	KYB	70584		
343432	KYB	36867		
343432	KYB	36867		
343432	KYB	69412		
343442	KYB	G45890		
343442	KYB	G45890		
343472	KYB	G45891		
343478	KYB	G45897		
343479	KYB	62011		
343484	KYB	62008		
343807	KYB	62001		
343807	KYB	62001		
343809	KYB	G45890		
344001	KYB	36761		
344004	KYB	G45450		
344031	KYB	G45418		
344041	KYB	G63423		
344044	KYB	G56116		
344058	KYB	G56172	G45869	
344058	KYB	G56241		
344059	KYB	G56175	G45873	
344059	KYB	G45873		
344060	KYB	G56179		
344063	KYB	G56116	G45006	
344064	KYB	G45466		
344064	KYB	G56185		
344085	KYB	G56116		
344088	KYB	G578025		
344102	KYB	G45051		
344105	KYB	G63612		
344115	KYB	69919		
344200	KYB	G45871		
344202	KYB	G56189		
344203	KYB	G56173		
344204	KYB	G56209		

Part #	Manufacturer	Gabriel		Model/Year/Side
		Primary	Alternative	
344207	KYB	G56179		
344217	KYB	G56166		
344222	KYB	46004		
344223	KYB	46005		
344229	KYB	E663659		
344230	KYB	69901		
344257	KYB	G63935		
344288	KYB	83454		
344288	KYB	83456		
344297	KYB	61284		
344300	KYB	G56238		
344302	KYB	G56178		
344304	KYB	G56170		
344305	KYB	G56169		
344314	KYB	61289		
344318	KYB	55088		
344320	KYB	G56177		
344325	KYB	G56102		
344334	KYB	G56102		94 on
344334	KYB	G56116		66-77
344346	KYB	G56172		
344359	KYB	G63720		
344361	KYB	G56174		
344389	KYB	36859		
344392	KYB	G63721		
344393	KYB	G578025		
344404	KYB	G56263		
344409	KYB	83450		
344410	KYB	G56227		
344418	KYB	G556261		
344420	KYB	G56214		
344421	KYB	G56213		
344421	KYB	G56215		
344421	KYB	G578006		
344446	KYB	62019		
344453	KYB	61287		
344454	KYB	61288		
344456	KYB	62007		
344458	KYB	62010		
344459	KYB	62018		
344485	KYB	G56209		
344493	KYB	G56211		
344800	KYB	69538		
344800	KYB	69538		



344804 – 443207

PARTS FINDER

Shocks, Struts & Cartridges

Part #	Manufacturer	Gabriel		Model/Year/Side
		Primary	Alternative	
344804	KYB	69512		
344807	KYB	61298		
344807	KYB	62003		
344808	KYB	62003		
344808	KYB	62003		
345005	KYB	G56165		
345005	KYB	GS78008		
345006	KYB	55227		
345010	KYB	G56231		
345010	KYB	G56231		
345014	KYB	G56164		
345014	KYB	GS78007		
345023	KYB	83456		
345023	KYB	GS78012		
345023	KYB	G56231		
345035	KYB	G56230		
345044	KYB	G56239		
345056	KYB	GS56260		
348027	KYB	G56236	GS56259	
349015	KYB	G56207		
349017	KYB	GS78010		
349018	KYB	69415		
349023	KYB	G56208		
349035	KYB	61297		
349035	KYB	61297		
349042	KYB	69102		Rear
349052	KYB	61270		
351700	KYB	G51099		
354003	KYB	GS56261		
362001	KYB	44217		1400 Nissan
363014	KYB	G44850		
363017	KYB	G44733		
363023	KYB	44614		Corolla
363060	KYB	55818		
363500	KYB	44085		E30 BMW
364001	KYB	44602		
364014	KYB	55811		
365007	KYB	44611		
365015	KYB	44614		
365021	KYB	44601		
365024	KYB	61906		
365043	KYB	61914		
365054	KYB	44933		
365069	KYB	61302		

Part #	Manufacturer	Gabriel		Model/Year/Side
		Primary	Alternative	
365076	KYB	44603		Cressida
365093	KYB	G44782		
365501	KYB	61909		
365501	KYB	44607		Cielo
365504	KYB	61918		
365504	KYB	44411		Astra
366002	KYB	61303		
366012	KYB	G44461		
400033	Gabriel India	55231		
400033	Gabriel India	55231		
441017	KYB	51309		
441021	KYB	61201		
441042	KYB	51310		
441079	KYB	G51059		
441960	KYB	51310		
442027	KYB	G45861		
443016	KYB	G56153		
443017	KYB	G56156		
443018	KYB	G45837		
443020	KYB	44505		
443022	KYB	44516		
443023	KYB	44514		
443045	KYB	G45419		Rear
443046	KYB	18727		Front
443078	KYB	G56171		
443079	KYB	G45432		
443079	KYB	G56157		
443080	KYB	G56171		
443081	KYB	G56105		
443085	KYB	G45523		
443093	KYB	G45812		
443105	KYB	G45813		
443107	KYB	G45008		
443108	KYB	G45398		
443127	KYB	G45666		
443134	KYB	G45874		
443164	KYB	51016		
443172	KYB	69050		
443181	KYB	G45466		
443186	KYB	G45870		
443186	KYB	G56186		
443188	KYB	G45844		
443190	KYB	G45869		
443207	KYB	36857		

PARTS FINDER

Shocks, Struts & Cartridges

443214 – 553308



Part #	Manufacturer	Gabriel		Model/Year/Side
		Primary	Alternative	
443214	KYB	G45862		
443217	KYB	G45870		
443225	KYB	61256		
443226	KYB	G56116		
443236	KYB	69081		
443236	KYB	69081		
443238	KYB	G56172	G45869	
443239	KYB	G56171		
443240	KYB	G56116	G45872	
443240	KYB	G56190		
443241	KYB	G56167		
443258	KYB	G56116		
443259	KYB	G56116	G45871	
443290	KYB	G56116		
443293	KYB	G56171		
443295	KYB	G56103		
443301	KYB	69431		
443305	KYB	G56116		
443400	KYB	69412		
443800	KYB	69068		
444023	KYB	G45051		1/2 Ton Bakkie
444023	KYB	G56102		Dyna, Coaster (78-95)
444023	KYB	G56116		Dyna, Coaster (66-77)
444025	KYB	G56116	G45006	
444026	KYB	G56162		
444036	KYB	G45450		
444039	KYB	G45535		
444039	KYB	G56176		
444042	KYB	G56162		
444043	KYB	G56126		
444043	KYB	G56163		
444054	KYB	G56166		
444062	KYB	G45667		
444062	KYB	G56120		
444077	KYB	G45258		
444083	KYB	76132		
444085	KYB	G56172	G45869	
444096	KYB	G56161		
444097	KYB	G56219		
444103	KYB	G56189		
444104	KYB	G56173		
444118	KYB	G45447		

Part #	Manufacturer	Gabriel		Model/Year/Side
		Primary	Alternative	
444129	KYB	G56119		
444130	KYB	G56168		
444135	KYB	G56169		
444136	KYB	G56170		
444150	KYB	G56172		
444162	KYB	G56178		
444172	KYB	G56175	G45873	
444225	KYB	G56157		
444257	KYB	G56185		
445005	KYB	G56112		
445009	KYB	G56113		
445010	KYB	83233		
445020	KYB	G56161		
445026	KYB	G56164		
445034	KYB	G56164		
445035	KYB	G56246	GS78029	
445036	KYB	G56247	GS78030	
445038	KYB	G56180		
551013	KYB	61902		
551018	KYB	61202		
551019	KYB	36849		
551022	KYB	69066		
551061	KYB	69966		
551805	KYB	42826		
551807	KYB	69928		
551900	KYB	G51217		
551921	KYB	69444		
553060	KYB	G56116		
553074	KYB	69677		
553085	KYB	G45523		
553137	KYB	61252		
553177	KYB	69744		
553183	KYB	61253		
553185	KYB	61254		
553200	KYB	69966		
553206	KYB	61262		
553218	KYB	69922		
553219	KYB	69938		
553225	KYB	69989		
553237	KYB	69956		
553241	KYB	62019		
553243	KYB	69507		
553245	KYB	69957		
553308	KYB	61299		



553337 – 721583

PARTS FINDER

Shocks, Struts & Cartridges

Part #	Manufacturer	Gabriel		Model/Year/Side
		Primary	Alternative	
553337	KYB	42942		
553365	KYB	62011		
554003	KYB	36761		
554004	KYB	55208		
554006	KYB	G45423		
554017	KYB	G45078		
554036	KYB	G56119		
554038	KYB	G56168		
554063	KYB	G56173		
554094	KYB	G63720		
554095	KYB	G56176		
554338	KYB	61287		
555004	KYB	G56165		
555608	KYB	61292		
632004	KYB	55804		Rear Right
632005	KYB	55804		Rear Left
632040	KYB	55816		
632073	KYB	55855		Rear Left
632116	KYB	G35300		Front Right
632117	KYB	G35295		Front Left
633004	KYB	44221		
633041	KYB	69095		
633137	KYB	55825		Front Right
633138	KYB	55825		Front Left
633179	KYB	70519		Front Left
633179	KYB	55896		
633181	KYB	70545		Rear Right
633181	KYB	70521		Rear Left
633181	KYB	55895		
633181	KYB	55901		
633182	KYB	70544		Rear Left
633182	KYB	70522		Rear Right
633182	KYB	55894		
633182	KYB	55902		
633204	KYB	35952		Front Right
633205	KYB	35951		Front Left
633274	KYB	55833		
633712	KYB	55811		
633718	KYB	G35421		
633730	KYB	70540		Front Right
633807	KYB	35824		
633827	KYB	70511		
633831	KYB	55858		
634001	KYB	35836		

Part #	Manufacturer	Gabriel		Model/Year/Side
		Primary	Alternative	
634026	KYB	G55601		
634073	KYB	G56518		Front Left
634100	KYB	35944		Front Right
634101	KYB	35943		Front Left
634102	KYB	35946		Rear Right
634103	KYB	35945		Rear Left
634810	KYB	55841		
662001	KYB	44227		
663016	KYB	44532		
663017	KYB	44225		
663018	KYB	44535		
664003	KYB	44510		
664007	KYB	44604		
664010	KYB	44564		
665011	KYB	44608		
665015	KYB	G44869		
665020	KYB	44612		
665020	KYB	44502		
665037	KYB	G44939		
665038	KYB	44613		
665042	KYB	44615		
665050	KYB	44601		
665058	KYB	61915		
700060	Gabriel India	61281		
700168	Gabriel India	36860		
700168	Gabriel India	36860		
700177	Gabriel India	36861		Front Right
700178	Gabriel India	36862		
700178	Gabriel India	36862		
700184	Gabriel India	61283		
700193	Gabriel India	61282		
700979	Gabriel India	36863		
700979	Gabriel India	36863		
721001	Gabriel Europe	14016		
721002	Gabriel Europe	14017		
721050	Gabriel Europe	14011		
721051	Gabriel Europe	14021		
721052	Gabriel Europe	14022		
721053	Gabriel Europe	14023		
721054	Gabriel Europe	14024		
721057	Gabriel Europe	14032		
721058	Gabriel Europe	14033		
721063	Gabriel Europe	14040		
721583	Gabriel Europe	55872		

Be safe. Be sure

PARTS FINDER

Shocks, Struts & Cartridges

722870 – 746880



Part #	Manufacturer	Gabriel		Model/Year/Side
		Primary	Alternative	
722870	Gabriel Europe	42314		
723212	Gabriel Europe	35117		
723501	Gabriel Europe	51006		
723527	Gabriel Europe	51026		
723534	Gabriel Europe	51160		
723538	Gabriel Europe	51310		
723617	Gabriel Europe	G35146		
731085	Gabriel Europe	G51059		
731102	Gabriel Europe	G51217		
731103	Gabriel Europe	G51216		
731133	Gabriel Europe	G51275		
733256	Gabriel Europe	G55760		
733303	Gabriel Europe	G55757		
733306	Gabriel Europe	G55760		
733313	Gabriel Europe	G55774		
733321	Gabriel Europe	G51186		
733329	Gabriel Europe	G55723		
733335	Gabriel Europe	G55795		
733341	Gabriel Europe	G55805		
733460	Gabriel Europe	G51227		
734372	Gabriel Europe	G55723		
734404	Gabriel Europe	G44706		
734409	Gabriel Europe	G44735		
734420	Gabriel Europe	G44705		
734425	Gabriel Europe	G44733		
734514	Gabriel Europe	G44773		
734534	Gabriel Europe	G44782		
734602	Gabriel Europe	G44869		
734607	Gabriel Europe	G44850		
734609	Gabriel Europe	G44895		
734650	Gabriel Europe	G44938		
734651	Gabriel Europe	G44939		
736001	Gabriel Europe	G51195		
736002	Gabriel Europe	G51196		
736020	Gabriel Europe	G51059		
736055	Gabriel Europe	G51082		
736551	Gabriel Europe	G44450		
736558	Gabriel Europe	G44461		
736701	Gabriel Europe	G56504		
736721	Gabriel Europe	G56504		
736722	Gabriel Europe	G55516		
736727	Gabriel Europe	G55514		
737519	Gabriel Europe	G63410		
737522	Gabriel Europe	G63414		

Part #	Manufacturer	Gabriel		Model/Year/Side
		Primary	Alternative	
737532	Gabriel Europe	G63422		
737533	Gabriel Europe	G63423		
737535	Gabriel Europe	G63425		
737904	Gabriel Europe	G63423		
739605	Gabriel Europe	G51089		
739607	Gabriel Europe	G51099		
739608	Gabriel Europe	G51100		
739609	Gabriel Europe	G51101		
739614	Gabriel Europe	G51097		
739617	Gabriel Europe	G51269		
746540	Gabriel Europe	G35216		
746541	Gabriel Europe	G35217		
746545	Gabriel Europe	G35220		
746546	Gabriel Europe	G35225		
746561	Gabriel Europe	G35222		
746566	Gabriel Europe	G35256		
746567	Gabriel Europe	G35261		
746568	Gabriel Europe	G35227		
746569	Gabriel Europe	G35228		
746570	Gabriel Europe	G35214		
746573	Gabriel Europe	G35221		
746578	Gabriel Europe	G35234		
746594	Gabriel Europe	G35288		
746598	Gabriel Europe	G35279		
746631	Gabriel Europe	G35289		
746632	Gabriel Europe	G35290		
746634	Gabriel Europe	G35292		
746635	Gabriel Europe	G35284		
746640	Gabriel Europe	G35295		
746641	Gabriel Europe	G35296		
746644	Gabriel Europe	G35299		
746645	Gabriel Europe	G35300		
746646	Gabriel Europe	G35301		
746650	Gabriel Europe	G35305		
746678	Gabriel Europe	G35326		
746705	Gabriel Europe	G55586		
746713	Gabriel Europe	G55592		
746721	Gabriel Europe	G55601		
746724	Gabriel Europe	G55600		
746773	Gabriel Europe	G55614		
746874	Gabriel Europe	G55652		
746875	Gabriel Europe	G55653		
746879	Gabriel Europe	G35037		
746880	Gabriel Europe	G35038		



746941 – 35-0550

PARTS FINDER

Shocks, Struts & Cartridges

Part #	Manufacturer	Gabriel		Model/Year/Side
		Primary	Alternative	
746941	Gabriel Europe	G55614		
746962	Gabriel Europe	G55673		
746971	Gabriel Europe	G35013		
746994	Gabriel Europe	G55679		
746995	Gabriel Europe	G55680		
747021	Gabriel Europe	G35101		
747030	Gabriel Europe	G35112		
747036	Gabriel Europe	G35118		
747037	Gabriel Europe	G35119		
747038	Gabriel Europe	G35120		
747046	Gabriel Europe	G35128		
747086	Gabriel Europe	G35146		
747090	Gabriel Europe	G35150		
747110	Gabriel Europe	G55697		
747115	Gabriel Europe	G35185		
747123	Gabriel Europe	G55910		
747157	Gabriel Europe	G35160		
747171	Gabriel Europe	G35177		
747187	Gabriel Europe	G35189		
747188	Gabriel Europe	G35190		
747191	Gabriel Europe	G35193		
747192	Gabriel Europe	G35194		
747196	Gabriel Europe	G35199		
747512	Gabriel Europe	G63508		
747552	Gabriel Europe	G63612		
747567	Gabriel Europe	G63626		
747576	Gabriel Europe	G63636		
747584	Gabriel Europe	G63659		
747588	Gabriel Europe	G63663		
747603	Gabriel Europe	G63679		
747613	Gabriel Europe	G63694		
747620	Gabriel Europe	G63737		
747939	Gabriel Europe	G63679		
747943	Gabriel Europe	G63690		
747968	Gabriel Europe	G63720		
747969	Gabriel Europe	G63721		
747970	Gabriel Europe	G63722		
748120	Gabriel Europe	G63914		
748141	Gabriel Europe	G63920		
748217	Gabriel Europe	G63935		
748242	Gabriel Europe	G63940		
748609	Gabriel Europe	G63914		
750803	Gabriel Europe	G35337		
750804	Gabriel Europe	G35338		

Part #	Manufacturer	Gabriel		Model/Year/Side
		Primary	Alternative	
750809	Gabriel Europe	G35343		
750810	Gabriel Europe	G35344		
750813	Gabriel Europe	G35347		
750814	Gabriel Europe	G35348		
750827	Gabriel Europe	G35361		
750828	Gabriel Europe	G35362		
750982	Gabriel Europe	G35412		
750983	Gabriel Europe	G35413		
750993	Gabriel Europe	G35361		
750994	Gabriel Europe	G35362		
755539	Gabriel Europe	G55514		
755560	Gabriel Europe	G35347		
755574	Gabriel Europe	G35365		
755580	Gabriel Europe	G35369		
755581	Gabriel Europe	G35370		
755586	Gabriel Europe	G35421		
756574	Gabriel Europe	G35226		
757002	Gabriel Europe	69425		
757046	Gabriel Europe	69512		
757157	Gabriel Europe	G35146		
800375	Gabriel India	55232		
800391	Gabriel India	55233		
800398	Gabriel India	55234		
911123	Monroe	G63690		
931964	Monroe	G55697		
93599614	Gabriel OE	4277		
0C970	Monroe	44611		
15-0202	Monroe	69664		
16-0132	Monroe	G56119		
16-0300	Monroe	46005		
16-0300	Monroe	GS78019		
16-0366	Monroe	G56169	GS56233	
16-0367	Monroe	G56170	GS78014	
16-0369	Monroe	EG63659		
16-0460	Monroe	G56246	GS78029	
16-0461	Monroe	G56247	GS78030	
16-0466	Monroe	G56239		
16-0500	Monroe	G56230		
16-0500	Monroe	GS78011		
16-0630	Monroe	G56205		
16-0630	Monroe	GS46009		
16-0640	Monroe	G56236	GS56259	
16-1712	Monroe	G56168		
35-0550	Monroe	70557		Front Right

Be safe. Be sure

PARTS FINDER

Shocks, Struts & Cartridges

35-0551 – E1115



Part #	Manufacturer	Gabriel		Model/Year/Side
		Primary	Alternative	
35-0551	Monroe	70556		Front Left
35-0552	Monroe	70559		Rear Right
35-0553	Monroe	70558		Rear Left
5003211-0301	Gabriel mnf #	76113		
B0005	Monroe	77011		
D0009	Monroe	70523		Front Left
D0009	Monroe	70524		Front Right
D0019	Monroe	70556		Front Left
D0019	Monroe	70557		Front Right
D0021	Monroe	70558		Rear Left
D0021	Monroe	70559		Rear Right
D0201	Monroe	G56518		Front Left
D0202	Monroe	44532		
D0407	Monroe	70542		Front Left
D0407	Monroe	70542		
D0407	Monroe	70543		Front Right
D0407	Monroe	70543		
D0801	Monroe	G44782		
D0801	Monroe	51309		
D2653	Monroe	G45398		
D4003	Monroe	61292		
D4044	Monroe	G56126		
D4044	Monroe	G56163		
D4426	Monroe	G56219		
D4426	Monroe	G578010		
D4445	Monroe	G56167		
D4462	Monroe	G56171		
D4463	Monroe	G45872		
D4473	Monroe	G556260		
D4482	Monroe	G56185		
D4484	Monroe	G56174		
D4484	Monroe	G56113		
D4486	Monroe	G56171		
D5467	Monroe	G56158		
D5470	Monroe	46004		
D5471	Monroe	46005		
D5475	Monroe	36761		
D5476	Monroe	G63935		
D6415	Monroe	G56112		
D6415	Monroe	G56162		
D6437	Monroe	G56164		
D6643	Monroe	G56165		
D7003	Monroe	G56238		
D7004	Monroe	G63720		

Part #	Manufacturer	Gabriel		Model/Year/Side
		Primary	Alternative	
D7005	Monroe	G51255		
D7006	Monroe	G51256		
D7007	Monroe	G51227		
D7029	Monroe	G45122		
D7561	Monroe	G45432		
D7633	Monroe	G63799		
D7694	Monroe	G63940		
D7694	Monroe	36865		
D7703	Monroe	G56184		
D7705	Monroe	G45901		
D7706	Monroe	G45902		
D7841	Monroe	G51227		
D8005	Monroe	G56237		
D8014	Monroe	61287		
D8015	Monroe	61288		
D8016	Monroe	G56239		
D8019	Monroe	G56227		
D8019	Monroe	G578017		
D8020	Monroe	61289		
D8022	Monroe	83455		
D8023	Monroe	G56231		
D8023	Monroe	83456		
D8023	Monroe	G578012		
D8024	Monroe	G56218		
D8024	Monroe	G546007		
D8024	Monroe	G56226		
D8070	Monroe	46003	G546010	
D8343	Monroe	83454		
D8343	Monroe	46002		
D8344	Monroe	46001		
D8443	Monroe	G45054		
D8465	Monroe	G56173		
D8467	Monroe	G56167		Rear Left
D8483	Monroe	G56105		
D8641	Monroe	G56180		
D8902	Monroe	G56184		
E1007	Monroe	69050		
E1008	Monroe	69068		
E1020	Monroe	61248		
E1042	Monroe	69901		
E1071	Monroe	69081		
E1089	Monroe	G51023		
E1095	Monroe	61256		
E1104	Monroe	69921		
E1115	Monroe	36857		
E1115	Monroe	61239		



E1162 – E4963

PARTS FINDER

Shocks, Struts & Cartridges

Part #	Manufacturer	Gabriel		Model/Year/Side
		Primary	Alternative	
E1162	Monroe	G51089		
E1166	Monroe	G51023		
E1192	Monroe	G51213		
E1203	Monroe	69948		
E1233	Monroe	69425		
E1239	Monroe	69095		
E1239	Monroe	69082		
E1239	Monroe	G51235		
E1259	Monroe	69507		
E1274	Monroe	G45879		
E1276	Monroe	G51238		
E1278	Monroe	G51239		
E1284	Monroe	61298		
E1285	Monroe	61298		
E1286	Monroe	69924		
E1289	Monroe	G51275		
E1292	Monroe	69093		
E1293	Monroe	69415		
E1312	Monroe	69092		
E1312	Monroe	69092		
E1319	Monroe	69538		
E1331	Monroe	69512		
E1335	Monroe	69506		
E1336	Monroe	69507		
E1337	Monroe	61293		
E1338	Monroe	69987		
E1340	Monroe	70584		
E1341	Monroe	62018		
E1355	Monroe	61298		
E1356	Monroe	62003		
E2001	Monroe	62353		
E2020	Monroe	69087		
E2029	Monroe	69926		
E2034	Monroe	G51101		
E2040	Monroe	G51216		
E2041	Monroe	G51216		
E2042	Monroe	69087		
E2048	Monroe	69087		
E2051	Monroe	69946		
E2055	Monroe	69101		
E2056	Monroe	G56214		
E2058	Monroe	G56213		
E2068	Monroe	69102		
E2068	Monroe	69102		Rear

Part #	Manufacturer	Gabriel		Model/Year/Side
		Primary	Alternative	
E3411	Monroe	44085		
E3454	Monroe	G44461		
E3802	Monroe	61302		
E4201	Monroe	55811		
E4211	Monroe	55854		
E4273	Monroe	55863		
E4341	Monroe	55816		
E4342	Monroe	55817		
E4364	Monroe	55858		
E4370	Monroe	70511		
E4386	Monroe	G35296		Front Left
E4390	Monroe	G35365		
E4410	Monroe	55815		
E4424	Monroe	55840		
E4489	Monroe	55861		
E4493	Monroe	G35112		
E4499	Monroe	G35128		
E4499	Monroe	G35292		
E4508	Monroe	EG35115		
E4508	Monroe	EG35115		
E4513	Monroe	55841		
E4555	Monroe	G35160		
E4562	Monroe	G35190		
E4583	Monroe	G35216		
E4585	Monroe	G35189		
E4622	Monroe	G35228		
E4624	Monroe	G35228		
E4628	Monroe	G35227		
E4719	Monroe	70500		Front Left
E4733	Monroe	70519		Front Left
E4733	Monroe	70520		Front Right
E4743	Monroe	G35300		Front Right
E4749	Monroe	G35451		
E4750	Monroe	G35421		
E4879	Monroe	G35288		
E4882	Monroe	70505		
E4886	Monroe	G35199		Front Right
E4908	Monroe	61918		
E4908	Monroe	70505		
E4910	Monroe	70508		Front Left
E4910	Monroe	70509		Front Right
E4912	Monroe	70508		
E4912	Monroe	70509		
E4963	Monroe	G35289		Front Left

PARTS FINDER

Shocks, Struts & Cartridges

E4963 – GA2012



Part #	Manufacturer	Gabriel		Model/Year/Side
		Primary	Alternative	
E4963	Monroe	G35290		Front Right
E4972	Monroe	69922		
E4973	Monroe	G35348		Front Right
E4973	Monroe	G35412		Front Left
E4973	Monroe	G35413		Front Right
E4991	Monroe	70540		Front Right
E4991	Monroe	G35347		Front Left
E4997	Monroe	70503		
E5005	Monroe	69965		
E5026	Monroe	61253		
E5027	Monroe	61254		
E5038	Monroe	69919		
E5065	Monroe	69966		
E5066	Monroe	69423		
E5067	Monroe	69952		
E5068	Monroe	69966		
E5083	Monroe	69956		
E5084	Monroe	69957		
E5090	Monroe	69444		
E5091	Monroe	G51217		
E5091	Monroe	G51231		
E5099	Monroe	69446		
E5109	Monroe	61299		
E5117	Monroe	62032		
E5303	Monroe	69460		
E5309	Monroe	42826		
E5317	Monroe	69938		
E5609	Monroe	69928		
E7008	Monroe	55892		Front Left
E7008	Monroe	55892		
E7008	Monroe	55893		Front Right
E7008	Monroe	55893		
E7029	Monroe	70546		
E7030	Monroe	70546		
E7032	Monroe	55834		Front Left
E7032	Monroe	55835		Front Right
E7032	Monroe	55835		Front Right
E7036	Monroe	70587		Front Left
E7036	Monroe	70588		Front Right
E7038	Monroe	EG35046		Front Left
E7038	Monroe	EG35047		Front Right
E7045	Monroe	70631		Front Left
E7047	Monroe	70631		Front Left
E7047	Monroe	70632		Front Right

Part #	Manufacturer	Gabriel		Model/Year/Side
		Primary	Alternative	
E7057	Monroe	70581		
E7070	Monroe	70577		Left
E7070	Monroe	70578		Right
E7082	Monroe	70679		Front Left
E7082	Monroe	70680		Front Right
G0169	Gabriel India	35934		Front Left
G0170	Gabriel India	35935		Front Right
G0176	Gabriel India	51168		
G1055	Monroe	62003		
G1074	Monroe	G45890		
G1074	Monroe	G45890		
G1084	Monroe	G45897	62089	
G16387	Monroe	G35421		
G2101	Monroe	62018		
G72072	Monroe	G45413		
G7265	Monroe	G35370		Front Right
G7266	Monroe	G35369		Front Left
G7271	Monroe	70611		Front Right
G7272	Monroe	70610		Front Left
G7275	Monroe	70611		Front Right
G7276	Monroe	70610		Front Left
G7288	Monroe	70566		Rear Right
G7289	Monroe	70565		Rear Left
G7292	Monroe	70576		Front Right
G7292	Monroe	70576		
G7293	Monroe	70575		Front Left
G7293	Monroe	70575		
G7298	Monroe	70545		Rear Right
G7302	Monroe	G35326		
G8005	Monroe	70546		50mm OD
G8006	Monroe	70560		55mm OD
G8089	Monroe	70564		Front Right
G8090	Monroe	70563		Front Left
G8803	Monroe	70593		Front Right
G8804	Monroe	70592		Front Left
GA2006	Monroe	G45051		
GA2006	Monroe	G45051		
GA2007	Monroe	G45078		
GA2008	Monroe	G45006		
GA2008	Monroe	G56116		
GA2009	Monroe	G45535		
GA2009	Monroe	G56176		
GA2010	Monroe	G45398		
GA2011	Monroe	G45419		
GA2012	Monroe	G45466		



GA2015 – GT1026

PARTS FINDER

Shocks, Struts & Cartridges

Part #	Manufacturer	Gabriel		Model/Year/Side
		Primary	Alternative	
GA2015	Monroe	G45813		
GA2015	Monroe	G45841		
GA2016	Monroe	G56160		
GA2018	Monroe	G45875		
GA2019	Monroe	G56161		
GA2020	Monroe	G45877		
GA2021	Monroe	G45844		
GA2022	Monroe	61212		
GA2023	Monroe	G45862		GWM
GA2023	Monroe	G56178		K2700
GA2024	Monroe	G45870		GWM
GA2024	Monroe	G56103		4x4, 4x2 (Raised Height) (TF)
GA2024	Monroe	G56186		4x2 (Mk II)
GA2025	Monroe	G45869	G56172	Hi-Ace
GA2025	Monroe	G45869		Hardbody 4x2 (Excl. Hi Rider) (D21)/(D22)
GA2025	Monroe	G56172		Sani
GA2041	Monroe	G45469		
GA2041	Monroe	69069		
GA2054	Monroe	G45001		
GA2056	Monroe	G45399		
GA2056	Monroe	G45399		
GA2057	Monroe	G45841		
GA2057	Monroe	G45399		
GA2058	Monroe	G45417		
GA2062	Monroe	G45447		
GA2063	Monroe	G45212		
GA2063	Monroe	G56104		
GA2064	Monroe	G45503		
GA2064	Monroe	G45837		
GA2064	Monroe	G56153		
GA2065	Monroe	G45520		
GA2065	Monroe	G56156		
GA2066	Monroe	G45523		
GA2067	Monroe	G45255		
GA2067	Monroe	G45532		
GA2072	Monroe	G45742		
GA2074	Monroe	18727		
GA2075	Monroe	G45812		
GA2077	Monroe	G45810		
GA2078	Monroe	G45838		
GA2080	Monroe	G56159		
GA2081	Monroe	G56177		

Part #	Manufacturer	Gabriel		Model/Year/Side
		Primary	Alternative	
GA2097	Monroe	G45470		
GA72073	Monroe	G45715		
GT0102	Monroe	44602		
GT0104	Monroe	44614		
GT0104	Monroe	44614		
GT0106	Monroe	44608		
GT0107	Monroe	44510		
GT0111	Monroe	44606		
GT0112	Monroe	44615		
GT0114	Monroe	61915		
GT0115	Monroe	44603		
GT0116	Monroe	44611		
GT0117	Monroe	61909		
GT0117	Monroe	44607		
GT0118	Monroe	61914		
GT0119	Monroe	61918		
GT0120	Monroe	44603		
GT0120	Monroe	61903		
GT0120	Monroe	44613		
GT0401	Monroe	44217		
GT0402	Monroe	44535		
GT0701	Monroe	44505		
GT0702	Monroe	44085		
GT0720	Monroe	61903		
GT1001	Monroe	G51023		
GT1002	Monroe	61262		
GT1003	Monroe	G45879		
GT1004	Monroe	69082		
GT1004	Monroe	G51235		
GT1006	Monroe	61298		
GT1008	Monroe	G45859		
GT1011	Monroe	69050		
GT1011	Monroe	51006		
GT1012	Monroe	69068		
GT1013	Monroe	69092		
GT1014	Monroe	19022		
GT1015	Monroe	19021		
GT1016	Monroe	69081		
GT1017	Monroe	G51082		
GT1018	Monroe	69082		
GT1021	Monroe	61257		
GT1024	Monroe	G45839		
GT1025	Monroe	G45874		
GT1026	Monroe	61241		

PARTS FINDER

Shocks, Struts & Cartridges

GT1029 – GT7245



Part #	Manufacturer	Gabriel		Model/Year/Side
		Primary	Alternative	
GT1029	Monroe	61256		
GT1030	Monroe	G45881		
GT1033	Monroe	69075		
GT1034	Monroe	55820		
GT1059	Monroe	69089		
GT1069	Monroe	G45891		
GT1072	Monroe	62006		
GT2001	Monroe	G45878		
GT2002	Monroe	G45869		
GT2026	Monroe	55088		
GT2026	Monroe	55211		
GT2027	Monroe	36857		
GT2028	Monroe	G45466		
GT2030	Monroe	G45871		
GT2031	Monroe	G56116		
GT2032	Monroe	G45876		
GT2033	Monroe	36859		
GT2035	Monroe	G56178		
GT2036	Monroe	G45008		
GT2039	Monroe	G56172		
GT2042	Monroe	G45489		
GT2042	Monroe	61230		
GT2042	Monroe	G45138		
GT2043	Monroe	61248		
GT2044	Monroe	G56103		
GT2045	Monroe	G56189		
GT2046	Monroe	G56167		Rear Left
GT2050	Monroe	69073		
GT2051	Monroe	69079		
GT2082	Monroe	G56224		
GT2083	Monroe	G45860		
GT2084	Monroe	G45535		
GT2084	Monroe	G56244		
GT2085	Monroe	36767		
GT2090	Monroe	69074		
GT2091	Monroe	G45889		Front Right
GT2092	Monroe	G45888		Front Left
GT2093	Monroe	G56208		
GT2094	Monroe	G56211		
GT2096	Monroe	G45873		
GT2096	Monroe	G56175		
GT2102	Monroe	G56209		Quantum
GT2102	Monroe	G56245		Inyathi
GT2107	Monroe	G56212		

Part #	Manufacturer	Gabriel		Model/Year/Side
		Primary	Alternative	
GT2202	Monroe	69101		
GT2203	Monroe	51309		
GT2203	Monroe	62350		
GT2213	Monroe	61293		
GT7001	Monroe	35847		
GT7002	Monroe	35847		
GT7005	Monroe	55813		Rear Right
GT7006	Monroe	55813		Rear Left
GT7007	Monroe	55813		Rear Right
GT7008	Monroe	55813		Rear Left
GT7101	Monroe	55881		
GT7206	Monroe	55865		
GT7207	Monroe	70510		
GT7210	Monroe	55858		
GT7211	Monroe	35832		
GT7216	Monroe	55806		
GT7217	Monroe	55807		
GT7218	Monroe	55812		Front Right
GT7219	Monroe	55812		Front Left
GT7220	Monroe	35830		
GT7226	Monroe	55812		Front Right
GT7227	Monroe	55812		Front Left
GT7228	Monroe	55825		
GT7229	Monroe	55804	35833	
GT7230	Monroe	35816		
GT7230	Monroe	35844		
GT7231	Monroe	55817		
GT7232	Monroe	55816		
GT7233	Monroe	55854		
GT7234	Monroe	55840		
GT7235	Monroe	55855		Rear Left
GT7236	Monroe	35816		
GT7236	Monroe	55801		
GT7237	Monroe	35817		
GT7237	Monroe	55802		
GT7238	Monroe	35842		
GT7239	Monroe	55838		Front Left
GT7239	Monroe	55839		Front Right
GT7240	Monroe	55839		Front Right
GT7241	Monroe	G35146		
GT7242	Monroe	55819		Rear Right
GT7243	Monroe	55819		Rear Left
GT7244	Monroe	55863		Rear Right
GT7245	Monroe	55863		Rear Left



GT7249 – M8036

PARTS FINDER

Shocks, Struts & Cartridges

Part #	Manufacturer	Gabriel		Model/Year/Side
		Primary	Alternative	
GT7249	Monroe	55811		
GT7251	Monroe	55825		
GT7251	Monroe	35848		
GT7252	Monroe	35927		
GT7255	Monroe	55804		
GT7259	Monroe	70501		Front Right
GT7260	Monroe	70500		Front Left
GT7263	Monroe	70527		
GT7278	Monroe	55833		
GT7279	Monroe	70590		Front Right
GT7280	Monroe	70589		Front Left
GT7292	Monroe	70575		Front Left
GT7298	Monroe	70531		Rear Right
GT8020	Monroe	55872		
GT8021	Monroe	55893		Front Right
GT8022	Monroe	55892		Front Left
GT8023	Monroe	70503		
GT8026	Monroe	55856		Rear Right
GT8028	Monroe	55844		Front Right
GT8029	Monroe	55843		Front Left
GT8030	Monroe	55845		
GT8031	Monroe	55840		
GT8032	Monroe	55855		Rear Left
GT8033	Monroe	55848		Rear Left
GT8034	Monroe	55849		Rear Right
GT8035	Monroe	55846		Front Left
GT8036	Monroe	55847		Front Right
GT8037	Monroe	55841		
GT8038	Monroe	55886		Front Left
GT8039	Monroe	55887		Front Right
GT8042	Monroe	55861		Front Right
GT8043	Monroe	55861		Front Left
GT8044	Monroe	55818		
GT8046	Monroe	55818		Front Right
GT8047	Monroe	55818		Front Left
GT8050	Monroe	55835		Front Right
GT8050	Monroe	70588		Front Right
GT8051	Monroe	70587		Front Left
GT8058	Monroe	70546		
GT8059	Monroe	35937		Front Right
GT8060	Monroe	35936		Front Left
GT8061	Monroe	35939		Rear Right
GT8062	Monroe	35938		Rear Left
GT8123	Monroe	70714	70503	

Part #	Manufacturer	Gabriel		Model/Year/Side
		Primary	Alternative	
M0201	Monroe	G56518		Front Left
M1971	Monroe	61902		
M315	Monroe	61303		
M4434	Monroe	G56179		
M4441	Monroe	G45008		4x2 Std. Susp.
M4441	Monroe	G45870		KB (D-Max) 4x4 (Mk II), GWM 4x2
M4441	Monroe	G56103		4x4, 4x2 (Raised Height) (TF)
M4441	Monroe	G56186		4x2 (Mk II)
M4445	Monroe	G56167		
M4462	Monroe	G45844		KB (D-Max), TF Series
M4462	Monroe	G56171		1 Ton Bakkie
M4463	Monroe	G56116	G45872	
M4464	Monroe	55088		
M4464	Monroe	76132		
M4465	Monroe	G63612		
M4479	Monroe	EG63659		
M5454	Monroe	G56158		
M5454	Monroe	G578000		
M5464	Monroe	G56173		Hi-Ace, Isuzu 89-04
M5464	Monroe	G56244		Inyathi
M5468	Monroe	G56178		
M5470	Monroe	46004		
M6409	Monroe	G56240		
M6432	Monroe	G56189		
M6433	Monroe	G56231		
M6440	Monroe	G56165		
M6628	Monroe	G578007		
M6629	Monroe	G578008		
M6902	Monroe	G56184		
M6902	Monroe	36860		
M8029	Monroe	G56190		
M8030	Monroe	G56171		
M8031	Monroe	G56214		
M8031	Monroe	G556225		
M8032	Monroe	G56213		
M8032	Monroe	G56215		
M8032	Monroe	G578006		
M8034	Monroe	G56123		
M8035	Monroe	G56155		
M8036	Monroe	G56112		
M8036	Monroe	G56162		

Be safe. Be sure

PARTS FINDER

Shocks, Struts & Cartridges

M8037 – R2715



Part #	Manufacturer	Gabriel		Model/Year/Side
		Primary	Alternative	
M8037	Monroe	G56163		
M8038	Monroe	G45006		
M8038	Monroe	G56102		Dyna All
M8038	Monroe	G56116	G45006	KB (D-Max), TF Series
M8039	Monroe	G56102		
M8041	Monroe	55227		
M8042	Monroe	G56103		
M8046	Monroe	G45869		1 Ton Bakkie
M8046	Monroe	G56172	G45869	Hi-Ace
M8046	Monroe	G56172		Sani
M8047	Monroe	G56211		
M8048	Monroe	G56175	G45873	
M8049	Monroe	G45432		
M8049	Monroe	G56157		
M8050	Monroe	G56172		
M8052	Monroe	G578003		
M8056	Monroe	G56207		
M8056	Monroe	G578009		
M8058	Monroe	G45871		
M8059	Monroe	G56116		
M8074	Monroe	G56209		Quantum
M8074	Monroe	G56245		Inyathi
MG310	Monroe	61303		
MG971	Monroe	44601		
MG971	Monroe	61906		
MG998	Monroe	61914		
ML0023	Monroe	4081		
ML0250	Monroe	4501		
ML0250	Monroe	4312		
ML0265	Monroe	4321		
ML0299	Monroe	4324		
ML1133	Monroe	4332		
ML1233	Monroe	4320		
ML1250	Monroe	4260		
ML1361	Monroe	4328		
ML1413	Monroe	4063		
ML1418	Monroe	4333		
ML1485	Monroe	4064		
ML1514	Monroe	4221		
ML1653	Monroe	4277		
ML1653	Monroe	4308		
ML1881	Monroe	4079		
ML2029	Monroe	4272		

Part #	Manufacturer	Gabriel		Model/Year/Side
		Primary	Alternative	
ML2125	Monroe	4291		
ML2173	Monroe	4330		
ML2209	Monroe	4076		
ML2231	Monroe	4289		
ML2417	Monroe	4325		
ML2469	Monroe	4082		
ML2477	Monroe	4065		
ML2489	Monroe	4314		
ML2670	Monroe	4329		
ML2800	Monroe	4316		
ML2841	Monroe	4327		
ML3007	Monroe	4331		
ML3095	Monroe	4313		
ML3397	Monroe	4298		
ML3657	Monroe	4270		
ML4149	Monroe	4284		
ML4149	Monroe	4325		
ML4257	Monroe	4060		
MR819	Monroe	44225		
MR839	Monroe	44564		
MR916	Monroe	44604		
MR937	Monroe	44612		
MR951	Monroe	44614		
MR969	Monroe	G44850		
MR993	Monroe	44615		
R1000	Monroe	G45006		
R1581	Monroe	G45418		
R1581	Monroe	G63423		
R1610	Monroe	G56175		
R1611	Monroe	G56119		Jaguar
R1611	Monroe	G56168		Tracker
R1613	Monroe	G45871		
R1643	Monroe	36875		
R2029	Monroe	36760		
R2030	Monroe	36761		
R2592	Monroe	G45417		
R2602	Monroe	G45651		
R2605	Monroe	44516		
R2632	Monroe	61252		
R2646	Monroe	61256		
R2659	Monroe	G45535		
R2713	Monroe	69050		
R2714	Monroe	69068		
R2715	Monroe	14032		



R2716 – S1233

PARTS FINDER

Shocks, Struts & Cartridges

Part #	Manufacturer	Gabriel		Model/Year/Side
		Primary	Alternative	
R2716	Monroe	14011		
R2716	Monroe	14013		
R2719	Monroe	51016		
R2720	Monroe	51168		
R2721	Monroe	G56203	G556264	
R2722	Monroe	G56204	G556265	
R2724	Monroe	61202		
R2773	Monroe	61283		
R2773	Monroe	G45885		
R2775	Monroe	G45886		
R2775	Monroe	36862		
R2778	Monroe	61281		
R3216	Monroe	G56118		
R3216	Monroe	G45533		
R3269	Monroe	36849		
R3277	Monroe	19289		
R3277	Monroe	44227		
R3282	Monroe	36853		
R3405	Monroe	G45861		
R3410	Monroe	G45858		
R3469	Monroe	70532		Rear Left
R3469	Monroe	70533		Rear Right
R3472	Monroe	69921		
R3724	Monroe	36851		
R3737	Monroe	G55723		
R3750	Monroe	69076		
R3758	Monroe	G45861		
R3758	Monroe	G51059		
R3759	Monroe	55810		
R3769	Monroe	G55910		
R3776	Monroe	G51186		
R4434	Monroe	G56179		
R4434	Monroe	G56166		
R5410	Monroe	G45258		
R5522	Monroe	61282		
R6507	Monroe	51310		
R6519	Monroe	51310		
R7001	Monroe	55870		Rear Right
R7002	Monroe	55870		Rear Left
R7101	Monroe	55869		
R7202	Monroe	55811		
R7203	Monroe	35935		Front Right
R7204	Monroe	35934		Front Left
R7210	Monroe	55833		

Part #	Manufacturer	Gabriel		Model/Year/Side
		Primary	Alternative	
R8001	Monroe	G35348		Front Right
R8002	Monroe	G35347		Front Left
RS5602	Monroe	G556234		
RS999010	Monroe	G578003		
RS999039	Monroe	G556233		
RS999113	Monroe	G578018		
RS999113	Monroe	G578021		
RS999116	Monroe	G578016		
RS999116	Monroe	G556225		
RS999136	Monroe	G578000		
RS999144	Monroe	G578001		
RS999144	Monroe	G578004		Rear Left
RS999144	Monroe	G578009		
RS999144	Monroe	G578005		Rear Right
RS999145	Monroe	G556232		Front Left
RS999158	Monroe	G578002		
RS999188	Monroe	G556221		
RS999202	Monroe	G56240		
RS999202	Monroe	G578013		
RS999207	Monroe	G578011		
RS999213	Monroe	G578019		
RS999223	Monroe	G556220		
RS999284	Monroe	G556267	G56263	
RS999311	Monroe	G556259	G56236	
RS999321	Monroe	G578014		
RS999352	Monroe	G578015		
RS999357	Monroe	G578017		
RS999360	Monroe	G578029	G56246	
RS999361	Monroe	G578030	G56247	
RS999365	Monroe	G578020		
RS999764	Monroe	G56263		
RS999766	Monroe	G546008		
RS999777	Monroe	G546007		
RS999777	Monroe	G56226		
RS999787	Monroe	G546010	46003	
RS999802	Monroe	G546006		
S1003	Monroe	G45874		
S1007	Monroe	69050		
S1042	Monroe	69901		
S1043	Monroe	61252		
S1047	Monroe	G45860		
S1148	Monroe	G45893		
S1203	Monroe	69948		
S1233	Monroe	69989		

PARTS FINDER

Shocks, Struts & Cartridges

S1242 – SH872080



Part #	Manufacturer	Gabriel		Model/Year/Side
		Primary	Alternative	
S1242	Monroe	69422		
S1251	Monroe	69431		
S1264	Monroe	61262		
S3009	Monroe	55811		
S3404	Monroe	61918		
S3405	Monroe	61909		
S3804	Monroe	61302		
S4010	Monroe	55868		
S4031	Monroe	G35279		
S4032	Monroe	55870		
S4252	Monroe	55813		
S4255	Monroe	55856		Rear Right
S4277	Monroe	55812		
S4277	Monroe	55861		
S4299	Monroe	55807		
S4334	Monroe	55869		
S4342	Monroe	55817		
S4343	Monroe	G45859		
S4386	Monroe	G35301		Front Right
S4388	Monroe	G35295		Front Left
S4424	Monroe	55840		
S4441	Monroe	G55592		
S4545L	Monroe	55846		Front Left
S4547	Monroe	55848		Rear Left
S4562	Monroe	G35190		
S4571	Monroe	G55601		
S4572	Monroe	55843		Front Left
S4596	Monroe	EG35046		Front Left
S4853	Monroe	G55673		
S4858	Monroe	55872		
S4865	Monroe	55844		Front Right
S4886	Monroe	G35193		Front Left
S4910	Monroe	70509		Front Right
S4914	Monroe	70508		Front Left
S5017	Monroe	61202		
S5057	Monroe	69677		
S5082	Monroe	G45078		
S5085	Monroe	69401		
S5087	Monroe	69946		
SA1942	Monroe	14023		
SC2914	Monroe	14021		
SC2946	Monroe	14023		
SC2947	Monroe	14033		
SH136001	FEMO	61909		

Part #	Manufacturer	Gabriel		Model/Year/Side
		Primary	Alternative	
SH136555	FEMO	61918		
SH140521	FEMO	44217		
SH141571	FEMO	61903		
SH151720	FEMO	G45051		
SH155210	FEMO	61256		
SH155490	FEMO	G45879		
SH185515	FEMO	61248		
SH186060	FEMO	69050		
SH186066	FEMO	69068		
SH186132	FEMO	69089		
SH186578	FEMO	69092		
SH205510	FEMO	G56211		
SH212020	FEMO	55865		
SH212030	FEMO	70510		
SH235623	FEMO	55858		
SH236569	FEMO	70503		
SH236625	FEMO	55812		
SH236626	FEMO	55813		
SH236737	FEMO	55825		
SH236797	FEMO	55854		
SH236811	FEMO	55839		
SH236812	FEMO	55838		
SH237245	FEMO	55804		
SH237338	FEMO	55811		
SH237339	FEMO	55818		
SH237340	FEMO	55819		
SH237341	FEMO	55833		
SH237344	FEMO	55861		
SH237345	FEMO	55863		
SH237384	FEMO	55841		
SH241850	FEMO	35927		
SH255430	FEMO	55088		
SH255730	FEMO	G56116		
SH865690	FEMO	G45873		
SH865700	FEMO	G45869		
SH865710	FEMO	G45535		
SH866530	FEMO	G45813		
SH866550	FEMO	G45844		
SH866730	FEMO	G45870		
SH866735	FEMO	G45871		
SH866740	FEMO	G45872		
SH866750	FEMO	G45878		
SH867510	FEMO	G45008		
SH872080	FEMO	G56172		



TECHNICAL INFORMATION – SHOCKS, STRUTS & CARTRIDGES

This section gives you detailed technical information on our shocks, struts and cartridges. This includes technical guides, drawings, and end mounting details, all of which is referenced to and from the vehicle listing and the parts listing.

Included in this section is a Fitment Guide which provides additional information on the removal, fitment and disposal of our products, as well as a section on extended and collapsed lengths that gives you the dimensions of our products as well as the end mountings and accessory packs that come with the product.

Section Content	Page
Key to Mounting Codes	162
How to Measure Extended and Collapsed Lengths	162
How to Protect your Struts	162
Technical guide to drawings	163
Removal and fitment of shocks	164
Removal and fitment of struts	165
Parts Listing	166



KEY TO MOUNTING CODES

Rubber Eyes		Sleeved Eyes		Other	
RE 16 = 16 mm I.D	SE 9 = 9 mm I.D	SE 16 = 16 mm I.D	B = Bracket	P = Plate	
RE 17 = 17 mm I.D	SE 10 = 10 mm I.D	SE 19 = 19 mm I.D	BP = Bar Pin	S = Stud	
RE 20 = 20 mm I.D	SE 11 = 11 mm I.D	SE 20 = 20 mm I.D	BT = Bolt	SM = Special Mounting	
RE 22 = 22 mm I.D	SE 12 = 12 mm I.D	SE 22 = 22 mm I.D	C = Cartridge	SS = Spring Seat Stud	
RE 25 = 25 mm I.D	SE 13 = 13 mm I.D	SE 24 = 24 mm I.D	DS = Dual Stud	SSE = Spring Seat Sleeved Eye	
	SE 14 = 14 mm I.D	SE 25 = 25 mm I.D	I.D = Inner Diameter	UB = U Bracket	
	SE 15 = 15 mm I.D	SE 31 = 31 mm I.D			

HOW TO MEASURE EXTENDED AND COLLAPSED LENGTHS

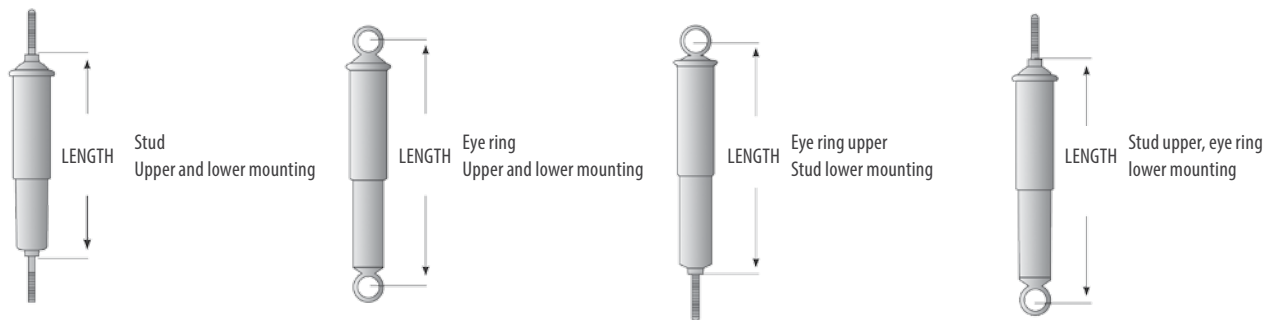

HOW TO PROTECT YOUR STRUTS

PART NO: 143057



GABRIEL STRUT CUSHION

Torre Automotive wants to emphasize the importance of renewing damaged or missing strut cushions (bump rubbers).

Damaged or missing strut cushions that are not replaced during strut and cartridge fitments can cause premature strut failure.

A strut cushion consists of a convoluted rubber boot or gaiter and a urethane compression bumper. These fit together and slide over the piston rod to rest on the strut's body.

The gaiter protects the strut's chrome piston rod from damage, keeps dirt out of the seal, pitting from stone chippings and corrosion from whatever the road may throw up.

The compression bumper, which fits into the boot, avoids internal damage being caused by preventing metal-to-metal contact under severe compression of the piston rod.



TECHNICAL GUIDE TO DRAWINGS

FIG 1 MacPherson Struts		FIG 2 MacPherson Cartridges	FIG 3 Spring Seat Shock Absorbers						
Fig 1.1	Fig 1.2	Fig 2	Fig 3.1	Fig 3.2	Fig 3.3	Fig 3.4			
With spring seat	Without spring seat	MacPherson Cartridges	With Bracket	With Sleeved eye With/without seat	With U Bracket	With Sleeved eye and Sleeved eye			
FIG 4 Stud & Barpin Shock Absorbers		FIG 5 Stud & Stud Shock Absorbers		FIG 6 Stud & Eye Shock Absorbers (with or without dust cover)		FIG 7 Stud & Special Mounting Shock Absorber		FIG 8 Eye & Eye Shock Absorbers	
Fig 4	Fig 5	Fig 6.1	Fig 6.2	Fig 7	Fig 8.1	Fig 8.2			
Stud & Barpin Shock Absorbers	Stud & Stud Shock Absorbers	Stud & rubber eye	Stud & Sleeved eye	NB: Special mountings come in numerous forms, e.g with special bracket as illustrated.	Bolt & Sleeved eye	Rubber eye & rubber eye			
FIG 8 Eye & Eye Shock Absorbers					FIG 9 Eye & Stud Shock Absorbers		FIG 10 Eye & Barpin Shock Absorbers		
Fig 8.3	Fig 8.4	Fig 8.5	Fig 9.1	Fig 9.2	Fig 10				
Rubber eye & Sleeved eye	Sleeved eye & rubber eye	Sleeved eye & Sleeved eye	Rubber eye & stud	Sleeved eye and stud	Sleeved eye & barpin				
FIG 11 Eye & Special Mounting Shock Absorbers		FIG 12 Barpin & Stud Shock Absorbers	FIG 13 Barpin & Eye Shock Absorbers		FIG 14 Gaslifts	FIG 15 Steering Dampers			
Fig 11.1	Fig 11.2	Fig 12	Fig 13.1	Fig 13.2	Fig 14	Fig 15			
NB: Special mountings come in numerous forms, e.g with bolt or bracket as illustrated.		Barpin & Stud Shock Absorbers	Rubber eye	Sleeved eye	Gaslifts	Steering Dampers			



REMOVAL AND FITMENT OF SHOCKS

REMOVAL OF SHOCKS

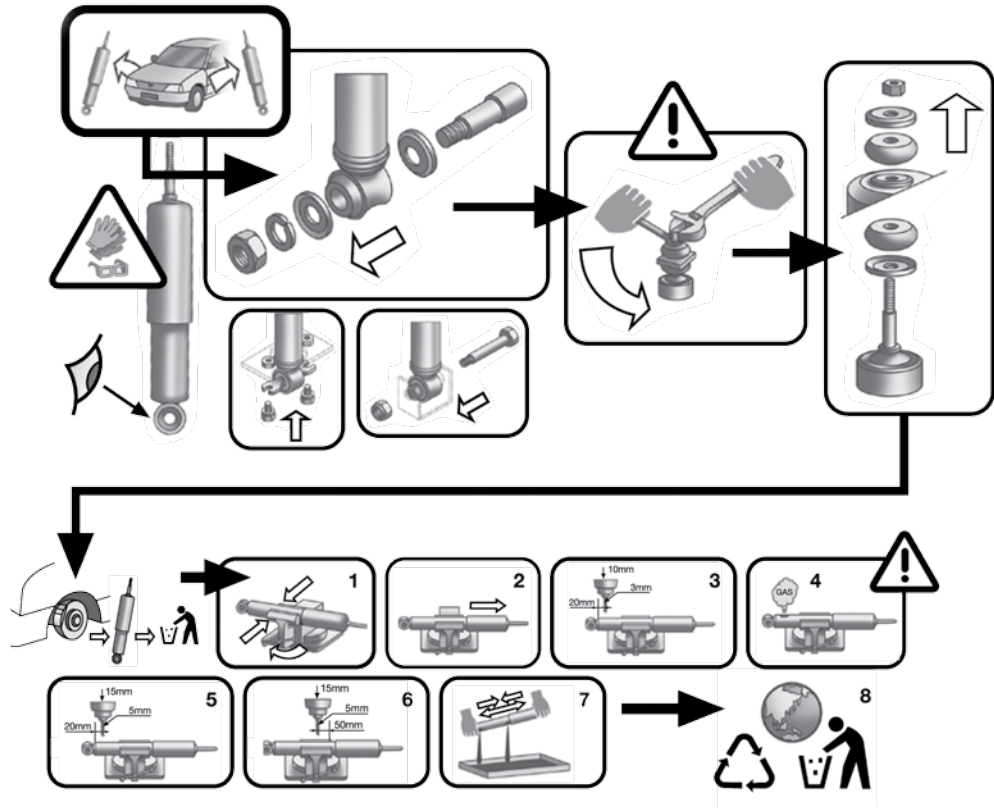

DISPOSAL OF SHOCKS

FITMENT OF SHOCKS

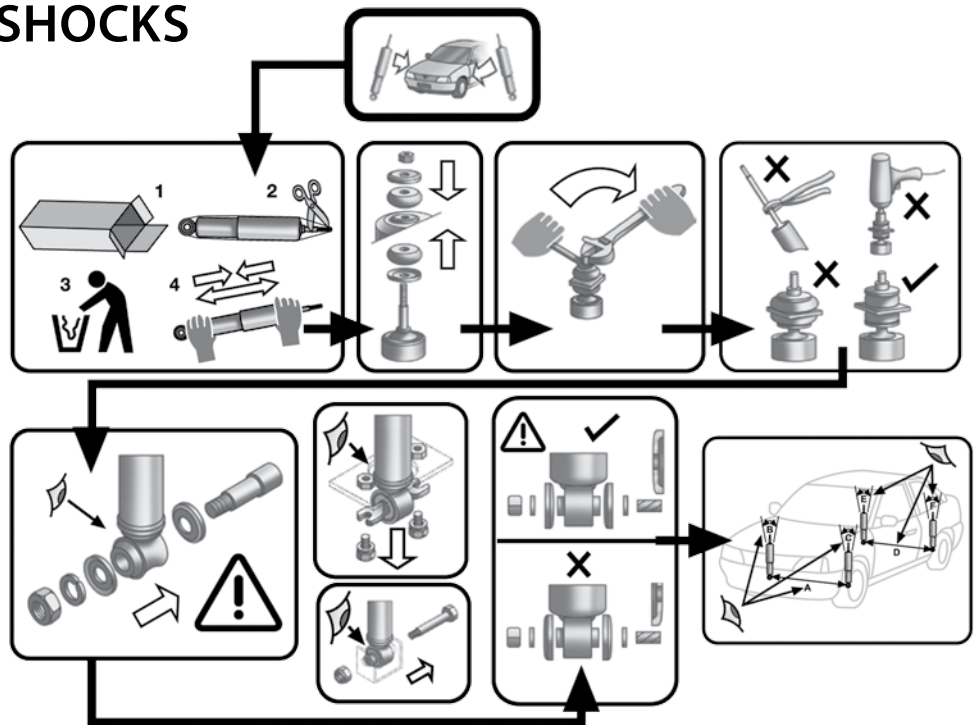

DISCLAIMER: Gabriel cannot be held liable in the event of injury or damage to property during assembly/disassembly/disposal process, if the product is not assembled/disassembled/disposed of at a fitment centre by a trained professional. This is a generic representation, and not all vehicles will have this type of shock configuration.



REMOVAL OF STRUTS

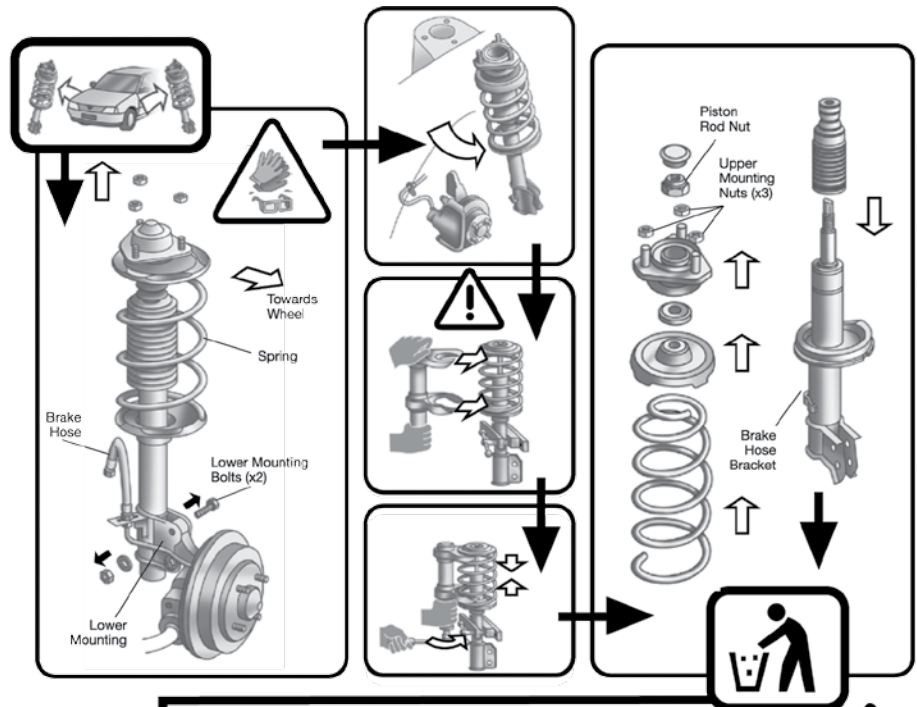

DISPOSAL OF STRUTS

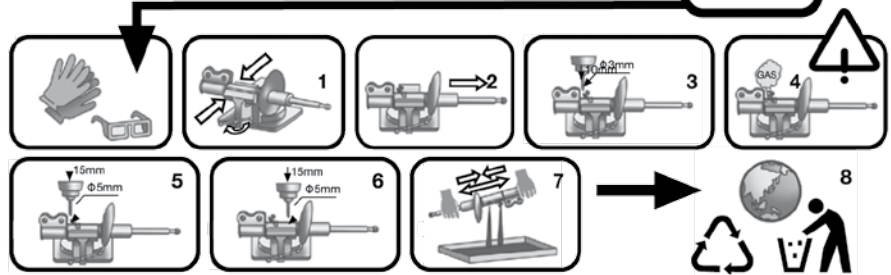

FITMENT OF STRUTS

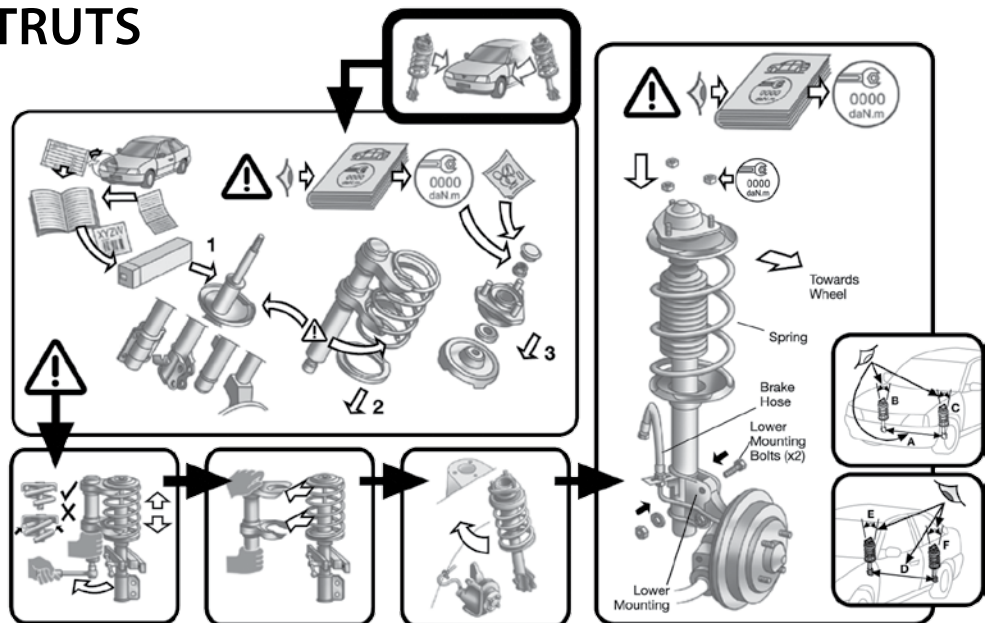

DISCLAIMER: Gabriel cannot be held liable in the event of injury or damage to property during assembly/disassembly/disposal process, if the product is not assembled/disassembled/disposed of at a fitment centre by a trained professional. This is a generic representation, and not all vehicles will have this type of shock configuration.



PARTS LISTING

Col. Length	Ext. Length	Upper Mounting	Lower Mounting	Accessory Kit	Shock Type			Part #
					Icon	Fig	Code	
GABRIEL GAS RYDER								
MACPHERSON STRUT – WITHOUT SPRING SEAT								
297	489	M12x1.25x23	B	144201		1.2	RE/RE	55802
SPRING SEAT SHOCK ABSORBERS – STUD UPPER, U BRACKET LOWER								
422	672	S	UB			3.3	SS/UB	69082
436	580	S	UB			3.3	SS/UB	69087
459	580	S	UB			3.3	SS/UB	G51097
459	580	S	UB			3.3	SS/UB	G51101
484	624	S	UB			3.3	SS/UB	69101
500	672	S	UB			3.3	SS/UB	G51089
SHOCK ABSORBERS – STUD UPPER, BAR PIN LOWER								
265	404	S	BPx75.0			4	S/BP	61243
279	439	S	BPx72.0	144015		4	S/BP	61701
312	516	S	BPx64.0			4	S/BP	G63721
314	510	S	BPx63.5			4	S/BP	G63424
343	458	S	BPx63.5			4	S/BP	G63678
SHOCK ABSORBERS – STUD UPPER AND LOWER								
243	383	S	S			5	S/S	G63920
262	390	S	S			5	S/S	G63799
297	518	S	S			5	S/S	69742
308	522	S	S			5	S/S	61702
401	560	S	S			5	S/S	69102
406	611	S	S			5	S/S	69654
SHOCK ABSORBERS – STUD UPPER, RUBBER EYE LOWER								
291	474	S	RE16			6.1	S/RE	69069
295	469	S	RE16			6.1	S/RE	G63410
302	477	S	RE16			6.1	S/RE	G63508
333	557	S	RE16			6.1	S/RE	61235
355	601	S	RE16	144070		6.1	S/RE	61228
358	615	S	RE16			6.1	S/RE	G63940
362	620	S	RE16	144076		6.1	S/RE	62020
371	633	S	RE16	144069		6.1	S/RE	61212
396	684	S	RE16	144069		6.1	S/RE	61230
SHOCK ABSORBERS – STUD UPPER, SLEEVED EYE LOWER								
228	348	S	SE12x32			6.2	S/SE	61287
231	348	S	SE12x34.0			6.2	S/SE	G63933
236	514	S	SE10x40.0			6.2	S/SE	61296
244	386	S	SE12x38.0			6.2	S/SE	G63935
246	367	S	SE12x32.0			6.2	S/SE	G63612

Col. Length	Ext. Length	Upper Mounting	Lower Mounting	Accessory Kit	Shock Type			Part #
					Icon	Fig	Code	
GABRIEL GAS RYDER (CONT...)								
SHOCK ABSORBERS – STUD UPPER, SLEEVED EYE LOWER (CONT...)								
255	378	S	SE13x38.0			6.2	S/SE	G63414
258	392	S	SE12x32.0			6.2	S/SE	G63737
265	432	S	SE14x41.0			6.2	S/SE	69901
272	439	S	SE10x36.0			6.2	S/SE	61256
288	400	S	SE14x44.5			6.2	S/SE	69104
288	468	S	SE11x32.5	144073		6.2	S/SE	69677
294	473	S	SE12x38.0			6.2	S/SE	G63663
299	458	S	SE16x36.0			6.2	S/SE	G63930
304	500	S	SE10x40.0	144152		6.2	S/SE	61241
309	551	S	SE10x36.0			6.2	S/SE	69891
312	525	S	SE13x53.0			6.2	S/SE	69633
313	510	S	SE20x42			6.2	S/SE	61288
315	502	S	SE10x40.0	144151		6.2	S/SE	61254
321	486	S	SE11x56.0			6.2	S/SE	69664
325	537	S	SE12x32.0			6.2	S/SE	69674
327	543	S	SE13x32.0			6.2	S/SE	G63720
331	551	S	SE12x32.0			6.2	S/SE	61233
334	543	S	SE			6.2	S/SE	69948
335	550	S	SE12x40.0			6.2	S/SE	61239
339	575	S	SE14x37			6.2	S/SE	69507
342	576	S	SE10x36.0			6.2	S/SE	61200
342	576	S	SE10x36.0			6.2	S/SE	61242
350	509	S	SE10x40.0	144153		6.2	S/SE	69744
351	575	S	SE16			6.2	S/SE	G63636
354	567	S	SE12x40.0			6.2	S/SE	69989
356	577	S	SE16x58.0			6.2	S/SE	G63483
359	535	S	SE12x40.0			6.2	S/SE	69425
359	595	S	SE14x37			6.2	S/SE	69506
363	583	S	SE15.6			6.2	S/SE	62024
362	608	S	SE 12.2			6.2	S/SE	62022
362	608	S	SE12.2x60			6.2	S/SE	61297
363	600	S	SE14x40			6.2	S/SE	62001
364	553	S	SE15			6.2	S/SE	62003
364	612	S	SE12x38.0			6.2	S/SE	G63936
365	471	S	SE15,5x65,5			6.2	S/SE	61292
368	617	S	SE12x43.0			6.2	S/SE	61248

TECHNICAL INFORMATION

Shocks, Struts & Cartridges

GAS RYDER™



Col. Length	Ext. Length	Upper Mounting	Lower Mounting	Accessory Kit	Shock Type			Part #
					Icon	Fig	Code	
GABRIEL GAS RYDER (CONT...)								
SHOCK ABSORBERS – STUD UPPER, SLEEVED EYE LOWER (CONT...)								
369	558	S	SE10x40.0			6.2	S/SE	61270
370	604	S	SE12x55			6.2	S/SE	62016
372	586	S	SE14x40			6.2	S/SE	62002
372	587	S	SE			6.2	S/SE	61293
374	569	S	SE10.2x40			6.2	S/SE	62005
374	585	S	SE14.2x36.9			6.2	S/SE	62018
375	532	S	SE10x40.0	144151		6.2	S/SE	61253
375	538	S	SE12			6.2	S/SE	62006
375	605	S	SE			6.2	S/SE	69942
375	605	S	SE			6.2	S/SE	69946
381	565	S	SE12x55			6.2	S/SE	62000
385	603	S	SE15.6			6.2	S/SE	61298
386	646	S	SE12x55			6.2	S/SE	61286
388	673	S	SE			6.2	S/SE	69460
389	595	S	SE16x38			6.2	S/SE	61289
393	588	S	SE12x60.0			6.2	S/SE	69926
394	641	S	SE10x45.0	Nut 413049		6.2	S/SE	61262
397	634	S	SE12x55			6.2	S/SE	61285
399	610	S	SE12x35.0			6.2	S/SE	69422
403	588	S	SE12x60.0			6.2	S/SE	69940
411	463	S	SE10x40.0			6.2	S/SE	69957
411	468	S	SE			6.2	S/SE	69928
411	637	S	SE10x41.0			6.2	S/SE	69964
414	536	S	SE10x41.0			6.2	S/SE	G63914
416	529	S	SE10x41.0			6.2	S/SE	69723
425	672	S	SE12x40			6.2	S/SE	62009
432	672	S	SE12x45.5			6.2	S/SE	61299
437	557	S	SE14x39.5			6.2	S/SE	62011
440	604	S	SE 12x43			6.2	S/SE	62021
446	473	S	SE10x40.0			6.2	S/SE	69956
465	569	S	SE10x40	144303		6.2	S/SE	62004
467	545	S	SE10x40.0			6.2	S/SE	69952
467	545	S	SE10x40.0			6.2	S/SE	69966
467	566	S	SE10			6.2	S/SE	69953
469	700	S	SE 12.2			6.2	S/SE	62023
481	624	S	SE15.5x40			6.2	S/SE	62012

Col. Length	Ext. Length	Upper Mounting	Lower Mounting	Accessory Kit	Shock Type			Part #
					Icon	Fig	Code	
GABRIEL GAS RYDER (CONT...)								
SHOCK ABSORBERS – STUD UPPER, SPECIAL MOUNTING LOWER								
354	468	S	SM	144014		7.1	S/SM	61202
370	484	S	SM	144014		7.1	S/SM	61201
SHOCK ABSORBERS – RUBBER EYE UPPER, SLEEVED EYE LOWER								
339	537	RE16	SE13x35.0			8.3	RE/SE	G63683
339	550	RE16	SE12x38.0			8.3	RE/SE	G63626
383	643	RE16	SE12x38.0			8.3	RE/SE	G63461
SHOCK ABSORBERS – SLEEVED EYE UPPER, RUBBER EYE LOWER								
271	386	SE10x34	RE16			8.4	SE/RE	69938
318	490	SE14x40	RE19x40	144031		8.4	SE/RE	E663659
SHOCK ABSORBERS – SLEEVED EYE UPPER AND LOWER								
205	339	SE10x38.0	SE10x38.0			8.5	SE/SE	69921
219	323	SE10x38.0	SE12x35.0			8.5	SE/SE	69934
219	323	SE10	SE12			8.5	SE/SE	69935
224	321	SE10x38.0	SE12x36.0			8.5	SE/SE	69919
240	333	SE12x40.0	SE14x40.0			8.5	SE/SE	69965
255	405	SE12	SE12			8.5	SE/SE	69769
256	392	SE12x48.0	SE14x40.0			8.5	SE/SE	69986
258	397	SE12x32.0	SE12x32.0			8.5	SE/SE	69431
259	373	SE12x48	SE12x40			8.5	SE/SE	61284
260	360	SE12x40	SE14x62			8.5	SE/SE	69446
260	365	SE12x40.0	SE14x62.0			8.5	SE/SE	69401
261	401	SE12x48.0	SE14x40.0			8.5	SE/SE	69415
262	383	SE12x35.0	SE12x36.0			8.5	SE/SE	69412
268	403	SE12x60.0	SE12x32.0			8.5	SE/SE	69689
269	416	SE12x48.0	SE14x40.0			8.5	SE/SE	69987
270	385	SE12x46.0	SE12x46.0			8.5	SE/SE	69914
271	421	SE12.4x48	SE14.2x40			8.5	SE/SE	62019
271	422	SE12x42.0	SE12x48.0			8.5	SE/SE	69616
272	418	SE13x42.5	SE13x42.5			8.5	SE/SE	G63423
289	456	SE10x36.0	SE10x36.0			8.5	SE/SE	61257
290	433	SE12.2x44	SE12.2x44	144274		8.5	SE/SE	62014
291	457	SE12x42.0	SE12x42.0			8.5	SE/SE	G63690
309	449	SE12x55.0	SE14x41.0			8.5	SE/SE	69922
311	473	SE12x40.0	SE12x40.0			8.5	SE/SE	62007
313	343	SE10	SE12			8.5	SE/SE	69444
317	513	SE10x32.0	SE12x32.0			8.5	SE/SE	61214
318	503	SE14x39.5	SE14x39.0			8.5	SE/SE	G63738



Col. Length	Ext. Length	Upper Mounting	Lower Mounting	Accessory Kit	Shock Type			Part #
					Icon	Fig	Code	
GABRIEL® TECHNOMATIC™ (CONT...)								
SHOCK ABSORBERS – STUD UPPER, SLEEVED EYE LOWER								
209	316	S	SE12x32.0	144068		6.2	S/SE	G45842
212	322	S	SE12x32.0	144070		6.2	S/SE	G45844
213	314	S	SE10x53.0	144070		6.2	S/SE	45410
218	335	S	SE12x32.0	144070		6.2	S/SE	G45869
219	334	S	SE12x32.0	144068		6.2	S/SE	G45893
228	354	S	SE10x67.0	144070		6.2	S/SE	45668
228	354	S	SE12x32.0	144070		6.2	S/SE	G45535
228	358	S	SE 12x32			6.2	S/SE	G45885
232	367	S	SE10x24.0	144029		6.2	S/SE	19022
237	373	S	SE12x32.0	144070		6.2	S/SE	G45871
241	380	S	SE11x32.0	144070		6.2	S/SE	45171
244	378	S	SE12x32			6.2	S/SE	61282
246	392	S	SE12x32	144068		6.2	S/SE	36868
259	404	S	SE12x59.5	144070		6.2	S/SE	G45459
260	421	S	SE10x40.0	144069		6.2	S/SE	45702
272	430	S	SE12x74.0	144023		6.2	S/SE	G45450
286	338	S	SE10x32.0	144075		6.2	S/SE	36850
291	481	S	SE12x32.0	144069		6.2	S/SE	G45861
294	487	S	SE13x33.0	144021		6.2	S/SE	G45742
316	532	S	SE12x32.0	144070		6.2	S/SE	45495
320	452	S	SE12x66.0			6.2	S/SE	36844
323	544	S	SE10x33.0	144070		6.2	S/SE	45436
326	551	S	SE12x32.0	144069		6.2	S/SE	G45859
329	554	S	SE12x32.0	144078		6.2	S/SE	G45838
335	554	S	SE12x40.0			6.2	S/SE	36857
339	576	S	SE10x36.0	144069		6.2	S/SE	G45839
339	576	S	SE10x36.0			6.2	S/SE	G45874
343	516	S	SE12x32.0	144070		6.2	S/SE	36767
345	493	S	SE12x66.0			6.2	S/SE	36826
363	597	S	SE10x51			6.2	S/SE	36866
367	633	S	SE10x36.0	144069		6.2	S/SE	G45489
368	528	S	SE12x32.0	144065		6.2	S/SE	36854
368.8	562.2	S	SE10x36.0			6.2	S/SE	G45897
370	620	S	SE10			6.2	S/SE	G45890
371	541	S	SE13x32.0			6.2	S/SE	36748
388	540	S	SE9x38.0	144030		6.2	S/SE	36855

Col. Length	Ext. Length	Upper Mounting	Lower Mounting	Accessory Kit	Shock Type			Part #
					Icon	Fig	Code	
GABRIEL® TECHNOMATIC™ (CONT...)								
SHOCK ABSORBERS – STUD UPPER, SLEEVED EYE LOWER (CONT...)								
394	631	S	SE10x36			6.2	S/SE	G45900
395	631	S	SE10x45.0			6.2	S/SE	G45879
404	560	S	SE14x32.0	144075		6.2	S/SE	36851
427	608	S	SE10x50.0			6.2	S/SE	36853
433	624	S	SE9x32.0	144030		6.2	S/SE	36849
479	674	S	SE12.2x51			6.2	S/SE	G45892
479	709	S	SE12.2x36			6.2	S/SE	G45894
SHOCK ABSORBERS – STUD UPPER, SPECIAL MOUNTING LOWER								
317	467	S	SM			7.1	S/SM	36847
330	557	S	SM	144014		7.1	S/SM	36760
331	477	S	SM			7.1	S/SM	36759
SHOCK ABSORBERS – STUD UPPER, SPECIAL MOUNTING LOWER								
225	345	S	DS	144070, 144059		7.2	S/DS	45164
SHOCK ABSORBERS – RUBBER EYE UPPER AND LOWER								
280	441	RE16	RE20			8.2	RE/RE	G45054
281	431	RE20	RE20	144031		8.2	RE/RE	G45873
305	499	RE16	RE16			8.2	RE/RE	36871
306	482	RE20	RE20	144031		8.2	RE/RE	G45051
314	514	RE16	RE16			8.2	RE/RE	61281
322	514	RE20	RE20	144031		8.2	RE/RE	G45006
327	526	RE16	RE16			8.2	RE/RE	G45872
336	558	RE16	RE16			8.2	RE/RE	G45870
341	556	RE17	RE17			8.2	RE/RE	45172
349	583	RE16	RE16			8.2	RE/RE	G45008
379	633	RE 19.5x42.2	RE 19.5x42.2	144031		8.2	RE/RE	36873
SHOCK ABSORBERS – RUBBER EYE UPPER, SLEEVED EYE LOWER								
295	475	RE16	SE12x32			8.3	RE/SE	36869
SHOCK ABSORBERS – SLEEVED EYE UPPER, RUBBER EYE LOWER								
285	443	SE13x41.0	RE16			8.4	SE/RE	45661
304	494	SE12x59.5	RE16			8.4	SE/RE	G45810
308	504	SE12x40	RE16			8.4	SE/RE	G45886
315	517	SE11x65.5	RE16			8.4	SE/RE	G45534
318	524	SE12x49.5	RE16			8.4	SE/RE	G45538
368	609	SE12x49.5	RE16			8.4	SE/RE	G45812



Col. Length	Ext. Length	Upper Mounting	Lower Mounting	Accessory Kit	Shock Type			Part #
					Icon	Fig	Code	
GABRIEL® TECHNOMATIC™ (CONT...)								
SHOCK ABSORBERS – SLEEVED EYE UPPER AND LOWER								
216	317	SE11x61.5	SE11x32.5			8.5	SE/SE	G45447
218	328	SE10x24.0	SE10x24.0			8.5	SE/SE	19021
254	393	SE12x32.0	SE12x32.0			8.5	SE/SE	18727
254	393	SE12x32.0	SE12x32.0			8.5	SE/SE	G45419
256	392	SE12x48.0	SE10x40.0			8.5	SE/SE	G45881
260	405	SE12x59.5	SE12x32.0			8.5	SE/SE	G45824
260	408	SE12x33.0	SE12x26.0			8.5	SE/SE	42575
261	390	SE12 (Flares to 15)	SE12			8.5	SE/SE	36867
266	418	SE12x32.0	SE12x32.0	144044		8.5	SE/SE	G45417
270	390	SE14x40	SE14x40			8.5	SE/SE	42942
279	443	SE10x32.0	SE10x32.0			8.5	SE/SE	G45877
283	454	SE12.2X32	SE12.2X32			8.5	SE/SE	G45896
284	445	SE16x38.0	SE16x38.0			8.5	SE/SE	42772
286	456	SE10x32.0	SE10x58.0			8.5	SE/SE	G45715
286	456	SE13x32.0	SE13x32.0			8.5	SE/SE	G45413
298	482	SE12x30.0	SE12x30.0			8.5	SE/SE	G45470
301	488	SE10x32.0	SE10x50.0			8.5	SE/SE	G45878
317	520	SE10x32.0	SE12x32.0			8.5	SE/SE	G45520
318	502	SE12x32.0	SE12x36.0			8.5	SE/SE	G45891
323	524	SE14x40.0	SE12x40.0			8.5	SE/SE	42864
327	539	SE12x40	SE12x40			8.5	SE/SE	36862
330	545	SE10x32.0	SE10x32.0			8.5	SE/SE	G45875
352	589	SE12x32.0	SE12x32.0			8.5	SE/SE	G45418
361	586	SE16x38.0	SE16x38.0			8.5	SE/SE	42773
363	617	SE14x30.0	SE14x30.0			8.5	SE/SE	G45468
366	606	SE16x40	SE16x40			8.5	SE/SE	36860
374	621	SE14x40	SE14x40			8.5	SE/SE	36863
377	464	SE14x40.0	SE12X49			8.5	SE/SE	42826
397	660	SE10x32.0	SE10x51.0			8.5	SE/SE	G45860
SHOCK ABSORBERS – RUBBER EYE UPPER, STUD LOWER								
285	468	RE16	S	144068		9.1	RE/S	G45432
SHOCK ABSORBERS – SLEEVED EYE UPPER, STUD LOWER								
266	430	SE13x32.00	S			9.2	SE/S	42447
SHOCK ABSORBERS – SLEEVED EYE UPPER, BAR PIN LOWER								
229	346	SE10x58.0	BPx86.5			10	SE/BP	G45837
229	346	SE10x75.0	BPx86.5			10	SE/BP	G45503
SHOCK ABSORBERS – BAR PIN UPPER, SLEEVED EYE LOWER								
285	461	BPx 58.5	SE12x25.0	144068		13.2	BP/SE	19290

Col. Length	Ext. Length	Upper Mounting	Lower Mounting	Accessory Kit	Shock Type			Part #
					Icon	Fig	Code	
GABRIEL® SAFARI™								
SPRING SEAT SHOCK ABSORBERS – STUD UPPER, BAR PIN LOWER								
219	331	S	BPx55.9	144073		4	S/BP	G56104
231	352	S	BPx66.5	144068		4	S/BP	G56185
235	363	S	BPx72.5	144068		4	S/BP	G56178
238	375	S	BPx81	144068		4	S/BP	G56251
276	438	S	BPx72.0	144015		4	S/BP	55208
SHOCK ABSORBERS – STUD UPPER AND LOWER								
268	441	S	S	144073, 144073		5	S/S	G56119
294	492	S	S	144073, 144073		5	S/S	G56105
303	511	S	S	144073, 144074		5	S/S	G56154
312	483	S	S	144287		5	S/S	G56239
326	552	S	S	144071, 144071		5	S/S	G56164
332	568	S	S	144073, 144074		5	S/S	G56120
340	591	S	S	144071, 144071		5	S/S	G56230
345	590	S	S	144071, 144071		5	S/S	G56180
SHOCK ABSORBERS – STUD UPPER, RUBBER EYE LOWER								
324	535	S	RE20	144068, 144031		6.1	S/RE	G56166
326	537	S	RE20	144282, 144031		6.1	S/RE	46002
328	547	S	RE16	144073		6.1	S/RE	55088
332	555	S	RE20	144068, 144031		6.1	S/RE	G56219
344	582	S	RE20	144071, 144031		6.1	S/RE	G56231
348	581	S	RE20	144071, 144031		6.1	S/RE	G56179
352	599	M10x1.25	RE20	144068, 144031		6.1	S/RE	55238
353	597	S	RE16	144037		6.1	S/RE	55211
SHOCK ABSORBERS – STUD UPPER, SLEEVED EYE LOWER								
211	314	S	SE12x32.0	144068		6.2	S/SE	G56171
218	333	S	SE12	144068		6.2	S/SE	G56241
221	333	S	SE12x32.0	144068		6.2	S/SE	G56172
230	350	S	SE12	144069		6.2	S/SE	46004
231	352	S	SE12x32.0	144068		6.2	S/SE	G56176
232	350	S	SE16x38.0	144068		6.2	S/SE	G56189
233	363	S	SE 12			6.2	S/SE	G56235



Col. Length	Ext. Length	Upper Mounting	Lower Mounting	Accessory Kit	Shock Type			Part #
					Icon	Fig	Code	
GABRIEL® SAFARI™ (CONT...)								
SHOCK ABSORBERS – STUD UPPER, SLEEVED EYE LOWER (CONT...)								
234	359	S	SE12x40.0	144068		6.2	S/SE	G56169
234	365	S	SE 12	144068		6.2	S/SE	G56244
237	371	S	SE12.2x32	144068		6.2	S/SE	G56211
239	364	S	SE12.2x40			6.2	S/SE	G56249
240	372	S	SE12x32.0	144068		6.2	S/SE	G56173
240	377	S	SE12x32			6.2	S/SE	G56203
241	347	S	SE12x40			6.2	S/SE	55231
243	364	S	SE12x40	144068		6.2	S/SE	G56222
252	382	S	SE14x80.0			6.2	S/SE	55227
259	416	S	SE12	144068		6.2	S/SE	G56214
272	425	S	SE13x37.5	144074		6.2	S/SE	G56123
272	435	S	SE12x32.0	144068		6.2	S/SE	G56158
297	486	S	SE13x37.5	144021		6.2	S/SE	G56118
300	458	S	SE16	144069		6.2	S/SE	46005
348	587	S	SE13x37.5	144021		6.2	S/SE	G56155
355	578	S	SE19.2	144282		6.2	S/SE	G56227
365	590	S	SE14			6.2	S/SE	G56238
SHOCK ABSORBERS –STUD UPPER, SPECIAL MOUNTING LOWER								
257	417	M14x1.5	SM			7.1	S/SM	G56258
SHOCK ABSORBERS –BOLT UPPER, SLEEVED EYE LOWER								
249	379	BT	SE13x35.0	144028		8.1	BT/SE	G56106
250	378	BT	SE13x35.0	144028		8.1	BT/SE	G56106
355	589	BT	SE14.5x42.5	144028		8.1	BT/SE	G56147
SHOCK ABSORBERS – RUBBER EYE UPPER AND LOWER								
278	432	RE20	RE20	144031 144031		8.2	RE/RE	G56112
279	436	RE16	RE16			8.2	RE/RE	G56177
281	431	RE20	RE20	144031		8.2	RE/RE	G56112
283	440	RE16	RE20	144031		8.2	RE/RE	G56175
306	482	RE20	RE20	144031		8.2	RE/RE	G56162
307	489	RE31	RE31			8.2	RE/RE	55241
308	489	RE18.9	RE20			8.2	RE/RE	55237
314	505	RE16	RE16			8.2	RE/RE	G56102
316	516	RE16	RE16	144072		8.2	RE/RE	G56210
322	514	RE20	RE20	144031		8.2	RE/RE	G56126
326	533	RE16	RE19			8.2	RE/RE	G56245
327	538	RE16	RE16			8.2	RE/RE	G56213

Col. Length	Ext. Length	Upper Mounting	Lower Mounting	Accessory Kit	Shock Type			Part #
					Icon	Fig	Code	
GABRIEL® SAFARI™ (CONT...)								
SHOCK ABSORBERS – RUBBER EYE UPPER AND LOWER (CONT...)								
330	537	RE16	RE16			8.2	RE/RE	G56116
337	550	RE 19.5x44.2	RE 19.5x44.2	144031		8.2	RE/RE	55240
336	550	RE16	RE16			8.2	RE/RE	55222
336	550	RE16	RE16			8.2	RE/RE	G56186
337	548	RE16	RE20			8.2	RE/RE	G56187
341	561	RE16	RE19			8.2	RE/RE	G56209
343	549	RE20	RE20	144242, 144242		8.2	RE/RE	G56208
348	558	RE19	RE19			8.2	RE/RE	G56252
349	575	RE16	RE16			8.2	RE/RE	G56190
349	582	RE16	RE16			8.2	RE/RE	G56215
351	571	RE20	RE20	144031, 144031		8.2	RE/RE	G56167
353	575	RE20	RE20	144242, 144242		8.2	RE/RE	G56207
355	588	RE16	RE16			8.2	RE/RE	G56103
361	582	RE12.2x43.5	RE12.2x43.5			8.2	RE/RE	G56247
365	607	RE16	RE16			8.2	RE/RE	G56184
365	611	RE16	RE16			8.2	RE/RE	G56250
376	622	RE20	RE20	144031, 144031		8.2	RE/RE	G56174
376	629	RE 19.5x44.2	RE 19.5x44.2	144031		8.2	RE/RE	55239
387	651	RE 19.5x44.2	RE 19.5x44.2	144031		8.2	RE/RE	55242
394	640	RE20	RE20	144031		8.2	RE/RE	G56240
SHOCK ABSORBERS – RUBBER EYE UPPER, SLEEVED EYE LOWER								
346	572	RE16	SE14			8.3	RE/SE	G56236
355	588	RE16	SE13x37.5			8.3	RE/SE	G56121
SHOCK ABSORBERS – SLEEVED EYE UPPER, RUBBER EYE LOWER								
330	538	SE12x40	RE16			8.4	SE/RE	G56204
SHOCK ABSORBERS – SLEEVED EYE UPPER AND LOWER								
262	394	SE 14x46	SE 14x40			8.5	SE/SE	G56268
277	427	SE12	SE15	144272		8.5	SE/SE	G56223
278	429	SE12	SE15x40			8.5	SE/SE	G56224
285	448	SE13x57.0	SE13x35.0			8.5	SE/SE	G56149
306	478	SE14.1	SE14.1			8.5	SE/SE	G56266
317	512	SE13x35.0	SE13x35.0			8.5	SE/SE	G56107
327	528	SE12x42.0	SE12x42.0			8.5	SE/SE	G56161
341	540	SE20x40	SE16x48	144272		8.5	SE/SE	G56228
351.4	564.5	SE12x45.5	SE12x40.0			8.5	SE/SE	G56263



Col. Length	Ext. Length	Upper Mounting	Lower Mounting	Accessory Kit	Shock Type			Part #
					Icon	Fig	Code	
GABRIEL® SAFARI™								
SHOCK ABSORBERS – SLEEVED EYE UPPER AND LOWER (CONT...)								
355	588	SE15x42.0	SE15x42.0		☉	8.5	SE/SE	GS6148
369	612	SE20x43.0	SE12x40.0		☉	8.5	SE/SE	GS6170
373	623	SE14x40.0	SE14x40.0		☉	8.5	SE/SE	55210
381	619	SE16x40	SE14x40		☉	8.5	SE/SE	55234
386	623	SE16x52	SE16x52		☉	8.5	SE/SE	55232
424	705	SE16x40	SE16x40		☉	8.5	SE/SE	55233
425	717	SE16x40.0	SE16x40.0		☉	8.5	SE/SE	55224
SHOCK ABSORBERS – RUBBER EYE UPPER, STUD LOWER								
290	466	RE20	S	144031	☽	9.1	RE/S	GS6113
291	473	RE16	S	144068	☽	9.1	RE/S	GS6157
309	504	RE20	S	144031, 144071	☽	9.1	RE/S	GS6163
329	549	RE16	S	144068	☽	9.1	RE/S	GS6168
SHOCK ABSORBERS – SLEEVED EYE UPPER, STUD LOWER								
300	492	SE12x32.0	S	144073	☽	9.2	SE/S	GS6156
300	492	SE14x32.0	S	144073	☽	9.2	SE/S	GS6159
335	555	SE19x44.5	S	144031, 144071	☽	9.2	SE/S	GS6165
SHOCK ABSORBERS – SLEEVED EYE UPPER, BAR PIN LOWER								
232	344	SE10x58.0	BPx86.5		☽	10	SE/BP	GS6160
232	344	SE10x75.0	BPx86.5		☽	10	SE/BP	GS6153
354	584	SE12x45	BP		☽	10	SE/BP	GS6246
GABRIEL® SAFARI HDP™								
SPRING SEAT SHOCK ABSORBERS – STUD UPPER, SLEEVED EYE LOWER								
258	386	S	SE14x40		☽	3.2	SS/SE	GS46010
297	427	S	SE14x48	144274	☽	3.2	SS/SE	GS46009
325	470	S	SE14	Nut 413053	☽	3.2	SS/SE	GS46006
340	470	S	SE14	144274 144288	☽	3.2	SS/SE	GS46008
410	552	S	SE14	144071	☽	3.2	SS/SE	GS46007
SPRING SEAT SHOCK ABSORBERS – STUD UPPER, BAR PIN LOWER								
228	351	S	BP	144274 144277	☽	4	S/BP	GS56234
SHOCK ABSORBERS – STUD UPPER AND LOWER								
318.8	538.6	S	S	144274 144288	☽	5	S/S	GS78002
327	553	S	S	144071, 144071	☽	5	S/S	GS78007
359	616	S	S	144071, 144071	☽	5	S/S	GS78011

Col. Length	Ext. Length	Upper Mounting	Lower Mounting	Accessory Kit	Shock Type			Part #
					Icon	Fig	Code	
GABRIEL® SAFARI HDP™ (CONT...)								
SHOCK ABSORBERS – STUD UPPER, RUBBER EYE LOWER								
328.5	538.5	S	RE19	144282 144274	☽	6.1	S/RE	GS78015
348	582	S	RE19	144068	☽	6.1	S/RE	GS78010
368	619	S	RE19	144282	☽	6.1	S/RE	GS78017
368	620	S	RE19	144071	☽	6.1	S/RE	GS78012
SHOCK ABSORBERS – STUD UPPER, SLEEVED EYE LOWER								
210	314	S	SE12	144068	☽	6.2	S/SE	GS56221
228	351	S	SE12	144068	☽	6.2	S/SE	GS56220
239	372	S	SE12x40	144277 144274	☽	6.2	S/SE	GS56233
244	380	S	SE16	144068	☽	6.2	S/SE	GS56232
244	381	S	SE12	144068	☽	6.2	S/SE	GS56225
244	387	S	SE12.2x32	144277 144274	☽	6.2	S/SE	GS56264
297	485	S	SE12	144068	☽	6.2	S/SE	GS78000
303	494	S	SE16	144068	☽	6.2	S/SE	GS78019
350	575	S	SE14	144068	☽	6.2	S/SE	GS78020
SHOCK ABSORBERS – RUBBER EYE UPPER AND LOWER								
355	585	RE16	RE16	144274	☽	8.2	RE/RE	GS78021
358	590	RE16	RE16		☽	8.2	RE/RE	GS78018
359	585	RE19	RE19		☽	8.2	RE/RE	GS78001
361	596	RE16	RE16		☽	8.2	RE/RE	GS78006
365	594	RE19	RE19		☽	8.2	RE/RE	GS78009
380	631	RE16	RE16	144274	☽	8.2	RE/RE	GS78016
381	626	RE19	RE19		☽	8.2	RE/RE	GS78004
381	639	RE16	RE16		☽	8.2	RE/RE	GS78003
394	653	RE19	RE19		☽	8.2	RE/RE	GS78005
395	657.1	RE19	RE19		☽	8.2	RE/RE	GS78013
SHOCK ABSORBERS – RUBBER EYE UPPER, SLEEVED EYE LOWER								
350	572.1	RE16	SE14	144274	☽	8.3	RE/SE	GS56259
SHOCK ABSORBERS – SLEEVED EYE UPPER, RUBBER EYE LOWER								
337.7	553.8	SE13.2x40	RE16	144274	☽	8.4	S/RE	GS56265
SHOCK ABSORBERS – SLEEVED EYE UPPER AND LOWER								
359	549	SE 12x46	SE 12x37		☽	8.5	SE/SE	GS56267
361	587	SE12.2x43.5	SE12.2x43.5		☽	8.5	SE/SE	GS78030
380.7	632.3	SE12x40	SE12x40		☽	8.5	SE/SE	GS78014
SHOCK ABSORBERS – RUBBER EYE UPPER, STUD LOWER								
344	563	RE19	S		☽	9.1	RE/S	GS78008
SHOCK ABSORBERS – SLEEVED EYE UPPER, BAR PIN LOWER								
360	586	SE	BP		☽	10	SE/BP	GS78029



Col. Length	Ext. Length	Upper Mounting	Lower Mounting	Accessory Kit	Shock Type			Part #
					Icon	Fig	Code	
GABRIEL® HEAVY DUTY								
SHOCK ABSORBERS – STUD UPPER AND LOWER								
199	303	S	S		†	5	S/S	83233
SHOCK ABSORBERS – STUD UPPER, RUBBER EYE LOWER								
318	506	S	RE20		‡	6.1	S/RE	83454
SHOCK ABSORBERS – STUD UPPER, SLEEVED EYE LOWER								
201	287	S	SE14x55.0		‡	6.2	S/SE	83373
291	439	S	SE20		‡	6.2	S/SE	83455
354	564	S	SE19x60.0		‡	6.2	S/SE	85319
362	588	S	SE19		‡	6.2	S/SE	83456
437	589	S	SE14x35.0		‡	6.2	S/SE	82606
SHOCK ABSORBERS – RUBBER EYE UPPER AND LOWER								
415	664	RE25	RE25		⊗	8.2	RE/RE	85320
SHOCK ABSORBERS – SLEEVED EYE UPPER AND LOWER								
187	238	SE11x35.0	SE11x35.0		⊗	8.5	SE/SE	83021
291	518	SE14x55.0	SE14x40.0		⊗	8.5	SE/SE	83450
368	579	SE19x96.5	SE19x81.5		⊗	8.5	SE/SE	85724
370	583	SE19x60.0	SE19x60.0		⊗	8.5	SE/SE	85918
SHOCK ABSORBERS – SLEEVED EYE UPPER, STUD LOWER								
223	322	SE12x52.0	S		♀	9.2	SE/S	83367
SHOCK ABSORBERS – BAR PIN UPPER, RUBBER EYE LOWER								
337	562	BPx72.9	RE16		⊖	13.1	BP/RE	81514
GABRIEL® FLEET RYDER®								
SHOCK ABSORBERS – STUD UPPER AND LOWER								
298	486	S	S	144036	†	5	S/S	76003
311	514	S	S	144036	†	5	S/S	76041
327	546	S	S		†	5	S/S	76133
336	565	S	S	144036	†	5	S/S	76009
349	590	S	S	144036	†	5	S/S	76020
365	600	S	S	144036, 144036	†	5	S/S	77000
368	628	S	S	144036, 144036	†	5	S/S	76006
380	633	S	S	144036, 144036	†	5	S/S	77012
395	682	S	S	144036	†	5	S/S	76206
406	683	S	S	144067, 144067	†	5	S/S	77004
419	730	S	S	144036	†	5	S/S	76034
448	767	S	S	144067, 144067	†	5	S/S	77006

Col. Length	Ext. Length	Upper Mounting	Lower Mounting	Accessory Kit	Shock Type			Part #
					Icon	Fig	Code	
GABRIEL® FLEET RYDER® (CONT...)								
SHOCK ABSORBERS – STUD UPPER, RUBBER EYE LOWER								
334	547	S	RE16	144068	‡	6.1	S/RE	76132
335	538	S	RE22	144036, 144000	‡	6.1	S/RE	76043
360	599	S	RE20	144037, 144031	‡	6.1	S/RE	76102
360	599	S	RE20		‡	6.1	S/RE	76155
373	614	S	RE22	144036, 144000	‡	6.1	S/RE	76016
375	617	S	RE20	142095 144000	‡	6.1	S/RE	76205
381	637	S	RE20	142095 144031	‡	6.1	S/RE	76204
382	643	S	RE20		‡	6.1	S/RE	76153
392	652	S	RE25	144067, 144011	‡	6.1	S/RE	76103
399	646	S	RE22		‡	6.1	S/RE	77011
408	652	S	RE20	144068	‡	6.1	S/RE	76108
430	729	S	RE25	144067, 144011	‡	6.1	S/RE	76035
430	729	S	RE25		‡	6.1	S/RE	76112
SHOCK ABSORBERS – STUD UPPER, SLEEVED EYE LOWER								
326	513	S	SE20x46.0	144036	‡	6.2	S/SE	76151
384	645	S	SE14x40.0	144037	‡	6.2	S/SE	76037
392	659	S	SE16x48.0	144036	‡	6.2	S/SE	76131
430	725	S	SE16x50.0	144036	‡	6.2	S/SE	76156
487	823	S	SE20x62.0	144067	‡	6.2	S/SE	77001
SHOCK ABSORBERS – RUBBER EYE UPPER AND LOWER								
327	514	RE20	RE20	144031	⊗	8.2	RE/RE	76015
345	546	RE20	RE20		⊗	8.2	RE/RE	76135
362	565	RE22	RE22	144011	⊗	8.2	RE/RE	76007
383	612	RE25	RE25	144011	⊗	8.2	RE/RE	76207
384	613	RE22	RE22	144000	⊗	8.2	RE/RE	76042
390	641	RE20	RE20	144031	⊗	8.2	RE/RE	76110
404	610	RE25	RE25	144011	⊗	8.2	RE/RE	77002
435	730	RE20	RE20	144031	⊗	8.2	RE/RE	76100
441	727	RE22	RE22	144000	⊗	8.2	RE/RE	76008



Col. Length	Ext. Length	Upper Mounting	Lower Mounting	Accessory Kit	Shock Type			Part #
					Icon	Fig	Code	
GABRIEL® FLEET RYDER® (CONT...)								
SHOCK ABSORBERS – SLEEVED EYE UPPER AND LOWER								
307	448	SE20x55.0	SE20x55.0		☉	8.5	SE/SE	77013
310	439	SE24x59.5	SE24x59.5		☉	8.5	SE/SE	77020
326	476	SE24x55.0	SE24x55.0		☉	8.5	SE/SE	77019
330	515	SE20x46.0	SE20x46.0		☉	8.5	SE/SE	76152
346	549	SE16x40.0	SE14x40.0		☉	8.5	SE/SE	76039
346	549	SE20x46.0	SE20x46.0		☉	8.5	SE/SE	76150
384	626	SE16x40.0	SE14x40.0		☉	8.5	SE/SE	76038
396	650	SE20x52.0	SE20x52.0		☉	8.5	SE/SE	76017
400	635	SE20x46.0	SE20x46.0		☉	8.5	SE/SE	77018
418	660	SE20x55.0	SE20x55.0		☉	8.5	SE/SE	76014
429	715	SE16x48.0	SE16x48.0		☉	8.5	SE/SE	76021
429	715	SE16x48.0	SE16x48.0		☉	8.5	SE/SE	76149
430	695	SE16x48.0	SE16x48.0		☉	8.5	SE/SE	77010
430	695	SE16x50.0	SE16x50.0		☉	8.5	SE/SE	77003
437	714	SE20x50	SE20x50		☉	8.5	SE/SE	76185
442	719	SE20x46.0	SE20x46.0		☉	8.5	SE/SE	77022
443	739	SE16x50.0	SE16x50.0		☉	8.5	SE/SE	76019
443	739	SE20x55.0	SE20x55.0		☉	8.5	SE/SE	76157
463	755	SE20x50	SE20x50		☉	8.5	SE/SE	76186

Col. Length	Ext. Length	Upper Mounting	Lower Mounting	Accessory Kit	Shock Type			Part #
					Icon	Fig	Code	
GABRIEL® FLEET RYDER® (CONT...)								
SHOCK ABSORBERS – SLEEVED EYE UPPER AND LOWER (CONT...)								
463	784	SE20x46.0	SE20x46.0		☉	8.5	SE/SE	76040
466	752	SE16x50.0	SE16x50.0		☉	8.5	SE/SE	77005
473	794	SE20x62.0	SE16x63.0		☉	8.5	SE/SE	76036
475	785	SE16x50.0	SE16x50.0		☉	8.5	SE/SE	77007
475	805	SE16x50.0	SE16x50.0		☉	8.5	SE/SE	76033
476	797	SE22x55.0	SE22x55.0		☉	8.5	SE/SE	76109
480	801	SE20x62.0	SE20x62.0		☉	8.5	SE/SE	76022
519	894	SE16x50.0	SE16x50.0		☉	8.5	SE/SE	76106
534	909	SE20x62.0	SE20x62.0		☉	8.5	SE/SE	76104
542	903	SE20x62.0	SE20x62.0		☉	8.5	SE/SE	77008
SHOCK ABSORBERS – SLEEVED EYE UPPER, STUD LOWER								
345	564	SE20x45.0	S		☉	9.2	SE/S	76134
SHOCK ABSORBERS – SLEEVED EYE UPPER, BAR PIN LOWER								
421	653	SE20x62.0	BPx100.0		☉	10	SE/BP	77009
472	758	SE20x62.0	BPx100.0		☉	10	SE/BP	77023



GASLIFTS & STEERING DAMPERS

The Gabriel® Gaslift® range is locally designed and developed to be a simple, hassle free, cost effective and customisable solution, that will allow you to take the lift out of lifting.

Used to open and close various items, the Gabriel® Gaslift® range is used on vehicle bonnets and -boots, doors, canopies, trailers, sunbeds, windows and many more applications.

Available in both an extensive automotive and industrial range, the Gabriels® Gaslift solution via a variety of high quality, long lasting end fittings that will best suite your application and lift angle. Also through our national gas filling solution, you can fill the differing units to the specific pressure that you will need to meet the required weight, angle and application.

Section Content	Page
Product Range and General Information	176
Vehicle Listing	178
Parts Listing	180
Parts Finder	182
Technical Information	183
• Universal Gaslifts	183
• Gas Filling Machine	183
• Custom Range Gaslifts	184
• Extended & Collapsed Lengths	185
Steering Dampers	187



PRODUCT RANGE

Gabriel® Gaslift®

Takes the lift out of lifting.

The Gabriel® Gaslift® series is designed to be a hassle free and customisable solution to assist in many various applications from, bonnet and boot applications, opening, holding open and closing doors to canopies, sun beds and window solution.

The Gabriel® Gaslift® range is also available in extensive automotive and industrial applications.

The range is supported through a variety of connection end fittings. Further, there is a national gas filling solution to fill units to a specific pressure to meet the required weight, angle and solution.

All of the range is covered by the Gabriel warranty and delivers up to its historical South African pedigree and provides for total peace of mind.



Gabriel® Gaslift®



Gabriel® Gaslift®

Product Features

- Ø16 and Ø19 Bore working cylinder
- Designed to be used to a pressure of up to 1000N (rod size applicable)
- Uses specific oil infused with nitrogen which is designed to work in South African and African climates
- Single lip rod seals
- Sintered metal rod guides
- NBR rod seals
- Gabriel® 12 month warranty

Product Benefits

- A hassle-free ready to use solution for both industrial and automotive requirements
- The industrial range can be customised for particular applications:
 - 4000 Series can be pressurised to 500N
 - 4100 Series can be pressurised to 1000N
- Plastic or metal end fittings to suit specific applications and cost options
- Universal canopy replacements
- Manufactured locally to the highest quality standards using premium quality components

The Gaslift® spring consists of a cylinder, piston and rod assembly able to extend and contract telescopically. The cylinder is filled with nitrogen gas at a very high pressure. It is this gas pressure which creates the lifting ability of the Gaslift® and the force exerted is proportional to the gas pressure.

A measured quantity of oil inside the Gaslift® lubricates the piston assembly and provides damping at the end of the extension movement. The damping imparts a more gentle action to the object being moved. Therefore, the Gaslift® should always be mounted with the rod in a downward position, when the door is fully opened.

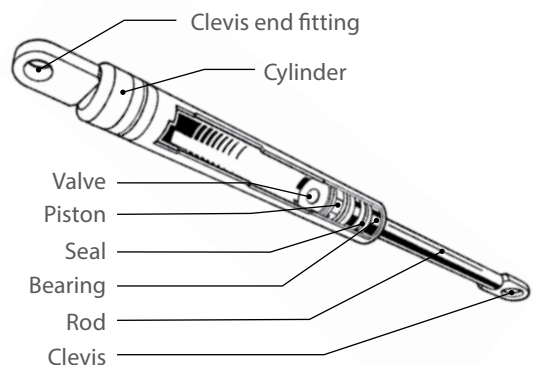



CALCULATING THE FORCE (F1)

Required to hold the lid in the Open position
Refer to the diagram:

- F1 – Force exerted by Gaslift® in Fully Extended Condition
- U – Upper Mounting Point
- L – Lower Mounting Point
- P – Pivot Point
- CG – Centre of Gravity
- A – Horizontal Distance from CG to Pivot Point P
- B – Perpendicular Distance from axis U-L to Pivot Point P
- W – Weight/Mass of lid

If the position of the CG of the lid is not known, then a spring balance or similar can be used to measure the force required to hold the door open. If the force is measured at the upper mounting point U this force plus 10 – 15% safety factor is the F1 required. If the force is measured at any other point, use the perpendicular distance from the pivot point P to the attachment point of the spring balance as A and the spring balance reading as W in the formula.

DIAGRAM OF TYPICAL APPLICATION

(*Refer formula to calculate)

$$* F1 = \frac{W \times A}{B} + 10 \text{ to } 15\% \text{ safety factor}$$

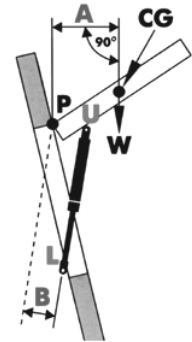

NOTE:

By changing the Gaslift® axis U - L the lid can be made to open automatically once the catch is released, or stay closed so that no catch is required. The calculated force is only enough to balance the mass – add more to keep the flap firmly in place. Work to low side of the calculated pressure at first because additional gas can be added, but pressure cannot be reduced.

GASLIFT APPLICATION (A SELECTION OF EXAMPLES)

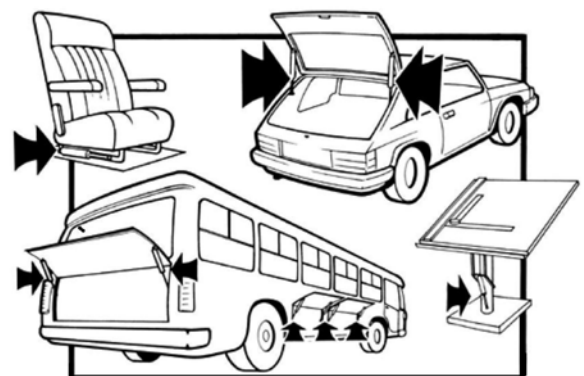
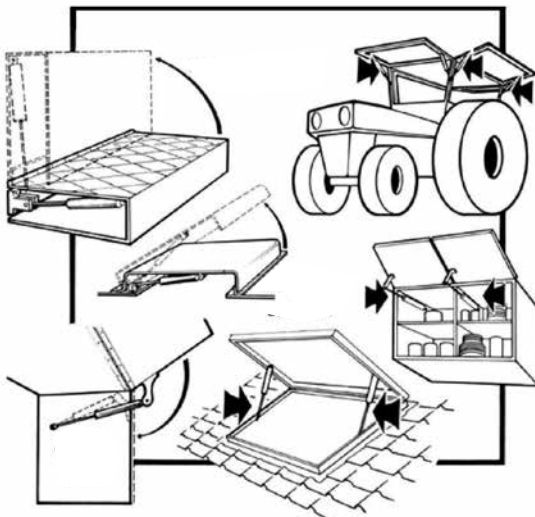



Make	Model	Derivative	Vehicle Type	Year	Front	Rear	Side	Status
Alfa-Romeo	Alfetta, Giulietta, Super,159I	(Incl. GT,GTV)		73-86		4125		OBS.
Audi	100, 200	(C1)		77-84	4066			OBS.
	400, 500	(C3, C4)		83-94	4081			
	A4	1.8, 2.4, 2.8 (8D2)		94-01		4284		
	A4	1.8, 2.4, 2.8 (8D2), Sedan		94-01	4321			OBS.
	A4	Avant (8D5)		96-99		4325	Tailgate	
	A6	Avant (4B,C5)		00 on		4326	Tailgate	
	A6	Sedan (4B)		97-99	4324			
	A6	Sedan (A4,C4)		94-97		4323		
BMW	3 Series	E30 Series, Sedan		83-92	4060			
	3 Series (With end-fittings)	E36 Series (excl. M3)		92-99		4269		
	3 Series (Without end-fittings)	E36 Series (excl. M3)		92-99		4285		
	3 Series	E36 Series (excl. M3)		92-99	4270			
	7 Series	E32 Series, Sedan		87-94	4060			
	7 Series	E23 Series, Sedan		78-87	4061			
Fiat	Palio	Hatchback		00 on		4327		
	Palio	Weekend		00 on		4328		
	Uno	All incl. Turbo		90-04		4063		
Ford	Escort	FWD L, GL, GLE P/C		81-86		4063		
	Escort	FWD XR3, Sport		81-86		4064		
	Escort	Mk V, Estate		95-99		4272		
	Fiesta	All		97-03		4063		
	Fiesta	Hatchback		97-03		4063		
	Fiesta	Mk V, Tailgate		04-08		4322		
	Focus	Mk I		98-04		4316		
	Granada	Sedan		72-86	4066			OBS.
	Laser, Meteor, Tracer	Sedan		86-01		4087		
	Sierra, Sapphire	2300, 2000, 1600, Sedan		83-93		4080		
	Sierra, Sapphire	2300, 2000, 1600 Estate		83-93		4080		
	Sierra, Sapphire	3000 (incl. XR6) PC		83-93		4127		
	Spectron	Minibus		91-03		4131		
	Telstar	Sedan		93-99		4502		
Honda	Civic	Hatchback		96-01		4289		
Isuzu	WFR, Relay	Panel van, Bus		84-95		4129		
Land Rover	Range Rover	Mk I		76-96		4205		
Mazda	323	(excl. S, EGi, Sport)		81-91		4071		
	323	(S, EGi, Sport)		81-91		4087		
	323	(incl. Midge)		91-04		4087		
	626	(Mk II, Mk III)		83-93		4071		
	626	Mk IV		92-98		4271		
	Marathon	Minibus, Van		91-03		4131		
	Soho	Hatchback		97-99		4063		
Mercedes-Benz	A Class	(W168) A160, A190, 170CDI		00-04		4329		
Nissan	E20	Ekonovan, Ekonowagon		73-95		4162		
	Langley, Pulsar	Incl. Panache (N10)		80-83		4099		
	Sabre	160,200		92-01		4515	Right	
	Sabre	160,200		92-01		4516	Left	



Make	Model	Derivative	Vehicle Type	Year	Front	Rear	Side	Status
Nissan (Continued)	Sentra	140, 160, 200		92-01		4268		
	Stanza, Resort	1600J, 1800J		78-83		4068		
	Z' Series	240, 260, 280ZX		70-81		4204		OBS.
Opel	Astra	(G)		99-03		4272		
	Astra	Estate (F)		94-01		4221		
	Chevair, Ascona	(C)		82-86		4080		
	Commodore	Estate		78-92		4014		OBS.
	Corsa	(B)		96-02		4277		
	Corsa	Corsa Lite (B)		02-07		4277		
	Corsa	Excl. Corsa Lite (C)		03-07		4308		
	Kadett	(Astra)		93-99		4260		
	Kadett	Hatchback		80-85		4069		
	Kadett	T-car (E)		85-93		4079		
Rekord	Estate (F)		78-92		4014		OBS.	
Peugeot	206	Estate		02 on		4333		
	206	Hatchback		00 on		4330		
	306	Estate		98-02		4332		
	307	Hatchback		02 on		4331		
	504	Estate		74-85		4065		
Renault	Clio	CLIO II		00-06		4298		
	Scenic	Mk I		96-03		4319	Window	
	Scenic	Mk I		96-03		4320	Tailgate	OBS.
Rover	2600, 3500 (V8)	Sedan		78-84		4014		OBS.
Suzuki	Carry	SUV		82-85		4208		OBS.
Toyota	Camry	(XV10), (XV20)		93-01	4165			
	Carri	(E90)		98-05		4273		
	Condor	MPV Mk IV		00-05		4521	Right	
	Condor	MPV Mk IV		00-05		4522	Left	
	Conquest, Tazz	FWD (E80)		85-89		4063		
	Conquest, Tazz	FWD (E90)		89-05		4273		
	Corolla	Estate (E70)		80-85		4207		
	Cressida	MX63 (Mk II)		81-93		4083		
	Cressida	Mk II Sedan, Wagon		81-93	4084			
	Hi-Ace	Super T (Minibus, Van)		69-02		4163		
Venture	(KF40)		91-00		4199			
Volkswagen	Citi	All		84 on		4065		
	Golf	Mk I,		78-84		4065		
	Golf	Mk II		84-92		4082		
	Golf	Mk III		93-99		4082		
	Golf	Mk IV		99-04		4314		
	Golf	Mk V		04-09	4312	4313		
	Jetta	Mk III		93-99		4501		
	Kombi	Microbus		80-02		4076		
	Passat	(B2)		82-87	4067	4068		
	Polo	Classic		96-02		4291		



Part #	Range	Superceding Part No/ Status.	Product Type	Position	Year	Make	Model	Derivative
4003	Gaslift®	Obsolete	Fig. 14	N/A	N/A	General	Industrial	Canopy
4014	Gaslift®	Obsolete	Fig. 14	Rear	78-92	Opel	Commodore	Estate
				Rear	78-92	Opel	Rekord	Estate (F)
				Rear	78-84	Rover	2600, 3500 (V8)	Sedan
4060	Gaslift®		Fig. 14	Front	83-92	BMW	3 Series	E30 Series, Sedan
				Front	87-94	BMW	7 Series	E32 Series, Sedan
4061	Gaslift®		Fig. 14	Front	78-87	BMW	7 Series	E23 Series, Sedan
4063	Gaslift®		Fig. 14	Rear	90-04	Fiat	Uno	All incl. Turbo
				Rear	81-86	Ford	Escort	FWD L, GL, GLE P/C
				Rear	97-03	Ford	Fiesta	ALL
				Rear	97-03	Ford	Fiesta	Hatchback
				Rear	97-99	Mazda	Soho	Hatchback
				Rear	85-89	Toyota	Conquest, Tazz	FWD (E80)
4064	Gaslift®		Fig. 14	Rear	81-86	Ford	Escort	FWD XR3, Sport
4065	Gaslift®		Fig. 14	Rear	74-85	Peugeot	504	Estate
				Rear	84 on	Volkswagen	Citi	All
				Rear	78-84	Volkswagen	Golf	Mk I,
4066	Gaslift®	Obsolete	Fig. 14	Front	77-84	Audi	100, 200	C1
				Front	72-86	Ford	Granada	Sedan
4067	Gaslift®		Fig. 14	Front	82-87	Volkswagen	Passat	B2
4068	Gaslift®		Fig. 14	Rear	78-83	Nissan	Stanza, Resort	1600J, 1800J
				Rear	82-87	Volkswagen	Passat	B2
4069	Gaslift®		Fig. 14	Rear	80-85	Opel	Kadett	Hatchback
4071	Gaslift®		Fig. 14	Rear	81-91	Mazda	323	Excl. S, EGi, Sport
				Rear	83-93	Mazda	626	Mk II, Mk III
4076	Gaslift®		Fig. 14	Rear	80-02	Volkswagen	Kombi	Microbus
4079	Gaslift®		Fig. 14	Rear	85-93	Opel	Kadett	T-car (E)
4080	Gaslift®		Fig. 14	Rear	83-93	Ford	Sierra, Sapphire	2300, 2000, 1600, Sedan
				Rear	83-93	Ford	Sierra, Sapphire	2300, 2000, 1600 Estate
				Rear	82-86	Opel	Chevair, Ascona	C
4081	Gaslift®		Fig. 14	Front	83-94	Audi	400, 500	C3, C4
4082	Gaslift®		Fig. 14	Rear	93-99	Volkswagen	Golf	Mk III
				Rear	84-92	Volkswagen	Golf	Mk II
4083	Gaslift®		Fig. 14	Rear	81-93	Toyota	Cressida	X30, X32 (Mk I)
4084	Gaslift®		Fig. 14	Front	81-93	Toyota	Cressida	X35, X36 (Mk I)
4087	Gaslift®		Fig. 14	Rear	86-01	Ford	Laser, Meteor, Tracer	Sedan
				Rear	81-91	Mazda	323	S, EGi, Sport
				Rear	91-04	Mazda	323	Incl. Midge
4098	Gaslift®		Fig. 14	Lid	N-A	Venter	Trailer	All
4099	Gaslift®		Fig. 14	Rear	80-83	Nissan	Langley, Pulsar	Incl. Panache (N10)
4125	Gaslift®	Obsolete	Fig. 14	Rear	73-86	Alfa-Romeo	Alfetta, Giulietta, Super, 159I	Incl. GT, GTV
4127	Gaslift®		Fig. 14	Rear	83-93	Ford	Sierra, Sapphire	3000 (incl. XR6) PC
4129	Gaslift®		Fig. 14	Rear	84-95	Isuzu	Wfr, Relay	Panel van, Bus
4131	Gaslift®		Fig. 14	Rear	91-03	Ford	Spectron	Minibus
				Rear	91-03	Mazda	Marathon	Minibus, Van
4162	Gaslift®		Fig. 14	Rear	73-95	Nissan	E20	Ekonovan, Ekonowagon
4163	Gaslift®		Fig. 14	Rear	69-02	Toyota	Hi-Ace	Super T (Minibus, Van)
4165	Gaslift®		Fig. 14	Front	93-01	Toyota	Camry	XV10, XV20
4199	Gaslift®		Fig. 14	Rear	91-00	Toyota	Venture	KF40
4204	Gaslift®	Obsolete	Fig. 14	Rear	70-81	Nissan	Z' Series	240, 260, 280ZX



Part #	Range	Superceding Part No/ Status.	Product Type	Position	Year	Make	Model	Derivative
4205	Gaslift®		Fig. 14	Rear	76-96	Land Rover	Range Rover	Mk I
4207	Gaslift®		Fig. 14	Rear	80-85	Toyota	Corolla	Estate (E70)
4208	Gaslift®	Obsolete	Fig. 14	Rear	82-85	Suzuki	Carry	SUV
4221	Gaslift®		Fig. 14	Rear	94-01	Opel	Astra	Estate (F)
4260	Gaslift®		Fig. 14	Rear	93-99	Opel	Kadett	Astra
4268	Gaslift®		Fig. 14	Rear	92-01	Nissan	Sentra	140, 160, 200
4269	Gaslift®		Fig. 14	Rear	92-99	Bmw	3 Series	E36 Series (excl. M3)
4270	Gaslift®		Fig. 14	Front	92-99	Bmw	3 Series	E36 Series (excl. M3)
4271	Gaslift®		Fig. 14	Rear	92-98	Mazda	626	Mk IV
4272	Gaslift®		Fig. 14	Rear	95-99	Ford	Escort	Mk V, Estate
				Rear	99-03	Opel	Astra	G
4273	Gaslift®		Fig. 14	Rear	98-05	Toyota	Carri	E90
				Rear	89-05	Toyota	Conquest, Tazz	FWD (E90)
4277	Gaslift®		Fig. 14	Rear	96-02	Opel	Corsa	B
				Rear	02-07	Opel	Corsa	Corsa Lite (B)
4284	Gaslift®		Fig. 14	Rear	96-01	Audi	A4	1.8, 2.4, 2.8 (8D2)
4285	Gaslift®		Fig. 15	Rear	91-99	Bmw	3 Series	E36 Series
4289	Gaslift®		Fig. 14	Rear	96-01	Honda	Civic	Hatchback
4291	Gaslift®		Fig. 14	Rear	96-02	Volkswagen	Polo	Classic
4294	Gaslift®		Fig. 14	Universal	N-A	Universal	Canopies	& Trailers
4295	Gaslift®		Fig. 14	Universal	N-A	Universal	Canopies	& Trailers
4296	Gaslift®		Fig. 14	Universal	N-A	Universal	Canopies	& Trailers
4297	Gaslift®		Fig. 14	Universal	N-A	Universal	Canopies	& Trailers
4298	Gaslift®		Fig. 14	Rear	00-06	Renault	Clio	CLIO II
4308	Gaslift®		Fig. 14	Rear	03-07	Opel	Corsa	Excl. Corsa Lite (C)
4312	Gaslift®		Fig. 14	Front	04-09	Volkswagen	Golf	Mk V
4313	Gaslift®		Fig. 14	Rear	04-09	Volkswagen	Golf	Mk V
4314	Gaslift®		Fig. 14	Rear	99-04	Volkswagen	Golf	Mk IV
4316	Gaslift®		Fig. 14	Rear	98-04	Ford	Focus	Mk I
4319	Gaslift®		Fig. 14	Rear	96-03	Renault	Scenic	Mk I (Rear Window)
4320	Gaslift®	Obsolete	Fig. 14	Rear	96-03	Renault	Scenic	Mk I (Tailgate)
4321	Gaslift®	Obsolete	Fig. 14	Front	96-01	Audi	A4	1.8, 2.4, 2.8 (8D2), Sedan
4322	Gaslift®		Fig. 14	Rear	04-08	Ford	Fiesta	Mk V, Tailgate
4323	Gaslift®		Fig. 14	Rear	94-97	Audi	A6	Sedan (A4,C4)
4324	Gaslift®		Fig. 14	Front	97-99	Audi	A6	Sedan (4B)
4325	Gaslift®		Fig. 14	Rear	96-99	Audi	A4	Avant (8D5) Tailgate
4326	Gaslift®		Fig. 14	Rear	00 on	Audi	A6	Avant (4B,C5) Tailgate
4327	Gaslift®		Fig. 14	Rear	00 on	Fiat	Palio	Hatchback
4328	Gaslift®		Fig. 14	Rear	00 on	Fiat	Palio	Weekend
4329	Gaslift®		Fig. 14	Rear	00-04	Mercedes-Benz	A Class	(W168) A160, A190, 170CDI
4330	Gaslift®		Fig. 14	Rear	00 on	Peugeot	206	Hatchback
4331	Gaslift®		Fig. 14	Rear	02 on	Peugeot	307	Hatchback
4332	Gaslift®		Fig. 14	Rear	98-02	Peugeot	306	Estate
4333	Gaslift®		Fig. 14	Rear	02 on	Peugeot	206	Estate
4501	Gaslift®		Fig. 14	Rear	93-99	Volkswagen	Jetta	Mk III
4502	Gaslift®		Fig. 14	Rear	93-99	Ford	Telstar	Sedan
4515	Gaslift®		Fig. 14	Rear Right	92-01	Nissan	Sabre	160,200
4516	Gaslift®		Fig. 14	Rear Left	92-01	Nissan	Sabre	160,200
4521	Gaslift®		Fig. 14	Rear Right	00-05	Toyota	Condor	MPV Mk IV
4522	Gaslift®		Fig. 14	Rear Left	00-05	Toyota	Condor	MPV Mk IV



Part #	Range	Superceding Part No/ Status.	Product Type	Position	Year	Make	Model	Derivative
PACK								SINGLE PART NUMBER
144221	Gaslift®		End Fittings	Top/Bottom	Custom	10 of	258251
144222	Gaslift®		End Fittings	Top/Bottom	Custom	10 of	358265
144223	Gaslift®		End Fittings	Top/Bottom	Custom	10 of	358264
144224	Gaslift®		End Fittings	Top/Bottom	Custom	10 of	258252
144225	Gaslift®		End Fittings	Top/Bottom	Custom	10 of	358270
144226	Gaslift®		End Fittings	Top/Bottom	Custom	10 of	358253
144227	Gaslift®		End Fittings	Top/Bottom	Custom	10 of	358271
144228	Gaslift®		End Fittings	Top/Bottom	Custom	10 of	358011
144229	Gaslift®		End Fittings	Top/Bottom	Custom	10 of	358257
144230	Gaslift®		End Fittings	Top/Bottom	Custom	10 of	258001
144231	Gaslift®		End Fittings	Top/Bottom	Custom	10 of	358028
144232	Gaslift®		End Fittings	Top/Bottom	Custom	10 of	258003
144233	Gaslift®		End Fittings	Top/Bottom	Custom	10 of	358021
144234	Gaslift®		End Fittings	Top/Bottom	Custom	10 of	358119
SINGLE								
258251	Gaslift®		End Fittings	Top/Bottom	Custom	144221	258251 x 10
358265	Gaslift®		End Fittings	Top/Bottom	Custom	144222	358265 x 10
358264	Gaslift®		End Fittings	Top/Bottom	Custom	144223	358264 x 10
258252	Gaslift®		End Fittings	Top/Bottom	Custom	144224	258252 x 10
358270	Gaslift®		End Fittings	Top/Bottom	Custom	144225	358270 x 10
358253	Gaslift®		End Fittings	Top/Bottom	Custom	144226	358253 x 10
358271	Gaslift®		End Fittings	Top/Bottom	Custom	144227	358271 x 10
358011	Gaslift®		End Fittings	Top/Bottom	Custom	144228	358011 x 10
358257	Gaslift®		End Fittings	Top/Bottom	Custom	144229	358257 x 10
258001	Gaslift®		End Fittings	Top/Bottom	Custom	144230	258001 x 10
358028	Gaslift®		End Fittings	Top/Bottom	Custom	144231	358028 x 10
258003	Gaslift®		End Fittings	Top/Bottom	Custom	144232	258003 x 10
358021	Gaslift®		End Fittings	Top/Bottom	Custom	144233	358021 x 10
358119	Gaslift®		End Fittings	Top/Bottom	Custom	144234	358119 x 10

PARTS FINDER

Manufacturer Part #	Manufacturer	Gabriel® Gaslift®
ML1653	Monroe	4308
ML1881	Monroe	4079
ML2029	Monroe	4272
ML2173	Monroe	4330
ML2231	Monroe	4289
ML2417	Monroe	4325
ML2477	Monroe	4065
ML2489	Monroe	4314
ML2670	Monroe	4329

Manufacturer Part #	Manufacturer	Gabriel® Gaslift®
ML2800	Monroe	4316
ML2841	Monroe	4327
ML2989	Monroe	4316
ML3007	Monroe	4331
ML3095	Monroe	4313
ML3397	Monroe	4298
ML3657	Monroe	4270
ML4149	Monroe	4284
ML4257	Monroe	4060



TECHNICAL INFORMATION

UNIVERSAL GASLIFTS – REPLACEMENT FOR CANOPIES AND TRAILERS

Part # 4294 – at standard force 250N replaces		
4045-104	4045-105	4045-106
4074-104	4074-105	4074-106
4075-104	4075-105	4075-106
4085-104	4085-105	4085-106

Part # 4295 – at standard force 250N replaces		
4023-104	4023-105	4023-106
4035-104	4035-105	4035-106
4043-104	4043-105	4043-106
4283-104	4283-105	4283-106

Part # 4296 – at standard force 350N replaces		
4045-106	4045-107	4045-108
4072-106	4072-107	4072-108
4074-106	4074-107	4074-108
4075-106	4075-107	4075-108
4085-106	4085-107	4085-108

Part # 4297 – at standard force 350N replaces		
4023-107	4023-108	
4035-107	4035-108	
4043-107	4043-108	

GAS FILLING MACHINE

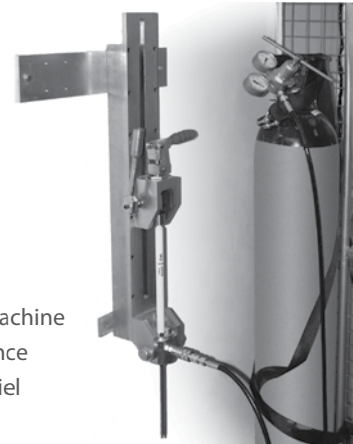

The Gabriel gas filling machine offers you the convenience of pressurizing the Gabriel industrial Gaslift to the application force required.

The gas filling machine may be purchased complete with regulators, hoses and fittings or these accessories may be bought separately.

Part #	Model	Derivative
144273	Gas Filling Machine	Gaslifts
144283	Hoses, Fittings & Trigger Valve	Gaslifts
144284	Harris High Pressure Regulator 987-170 Series	Gaslifts
144285	Harris Medium Pressure Regulator 987-100 Series	Gaslifts
144301	19mm gas springs. 8mm rods, 16mm seals	Black seals
144302	22mm gas springs. 10mm rods, 19mm seals	Black seals
S6-9-18306	19mm gas springs. 8mm rods, 16mm seals	Red seals
S6-9-21.5346	22mm gas springs. 10mm rods, 19mm seals	Red seals

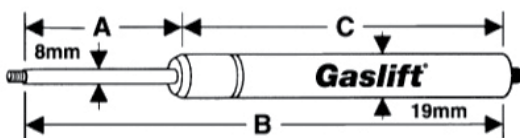

4000 Series 6mm End Fittings*

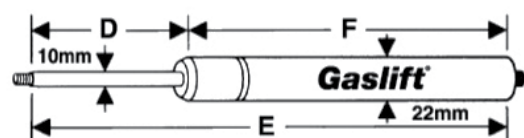
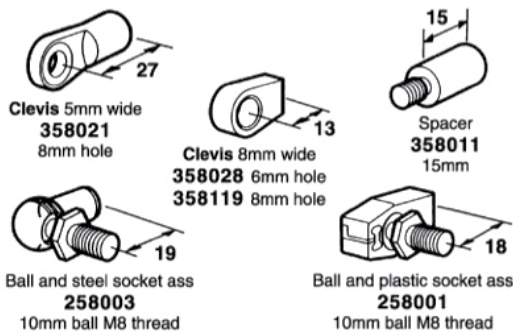

4100 Series 8mm End Fittings*

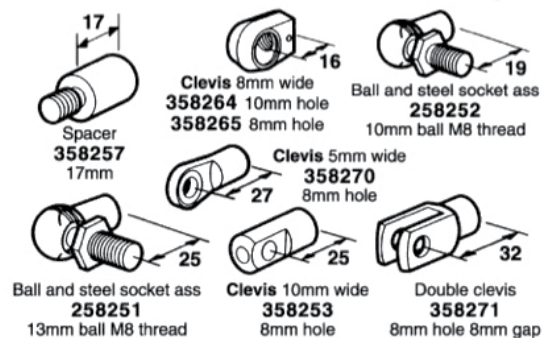

* NB: The above part numbers are **single units** (not sold separately by Gabriel). For **pack part numbers**, please refer to pg 183 | E&OE



4000 & 4100 SERIES

GASLIFTS

Custom Range

GASLIFTS CUSTOM RANGE

4000 series 6mm End Threads Can be pressurised as required up to 500N				
Gas Lift	A	B	C	Force
Part #	Stroke	Ext Length	Coll Length	Newtons
4040	82	200	118	50
4041	107	250	143	50
4042	132	300	168	50
4043	157	350	193	50
4044	182	400	218	50
4045	204	450	246	50
4046	230	500	270	50
4047	257	550	293	50
4048	282	600	318	50
4049	307	650	343	50
4050	332	700	368	50
4051	357	750	393	50
4052	382	800	418	50

4100 series 6mm End Threads Can be pressurised as required up to 1000N				
Gas Lift	A	B	C	Force
Part #	Stroke	Ext Length	Coll Length	Newtons
4140	157	350	193	50
4141	182	400	218	50
4142	207	450	243	50
4143	232	500	268	50
4144	257	550	293	50
4145	282	600	318	50
4146	307	650	343	50
4147	332	700	368	50
4148	357	750	393	50
4149	382	800	418	50
4150	407	850	443	50
4151	432	900	468	50
4152	457	950	493	50
4153	482	1000	518	50
4164	86	209	123	50

4000 series – 8mm Rod			
Required Force (N)	Pressure Settings (kPa)	mPa	Bar
100	1989	2.0	20
150	2983	3.0	30
200	3977	4.0	40
250	4972	5.0	50
300	5966	6.0	60
350	6960	7.0	70
400	7955	8.0	80
450	8949	8.9	89
500	9943	9.9	99

4100 series – 10mm Rod			
Required Force (N)	Pressure Settings (kPa)	mPa	Bar
100	1273	1.3	12.7
150	1909	1.9	19.1
200	2545	2.5	25.5
250	3182	3.2	31.8
300	3818	3.8	38.2
400	5091	5.1	50.9
450	5727	5.7	57.3
500	6364	6.4	63.6
550	7000	7.0	70.0
600	7636	7.6	76.4
650	8273	8.3	82.7
700	8909	8.9	89.1
750	9545	9.5	95.5
800	10182	10.2	101.8
850	10818	10.8	108.2
900	11455	11.5	114.5
950	12091	12.1	120.9
1000	12727	12.7	127.3



GASLIFTS

SORTED BY COLLAPSED AND EXTENDED LENGTHS

Collapsed Length	Extended Length	Body End	Rod End	Stroke	Force in Newtons	Part #
116	166	Clevis	Clevis	50	130	4003
118	200	None	None	82	50	4040
123	209	None	None	86	50	4164
143	250	None	None	107	50	4041
150	227	Clevis	Clevis	77	470	4268
163	258	Clevis	Clevis	95	350	4060
168	258	M6 Stud	M6 Stud	90	480	4285
168	300	None	None	132	50	4042
170	256	Socket	Socket	86	700	4501
181	288	Clevis	Socket	107	500	4284
181	288	Ball Stud	Ball Stud	107	300	4291
193	350	None	None	157	50	4043
193	350	None	None	157	50	4140
206	296	Socket	Socket	90	480	4269
215	353	Clevis	Clevis	138	320	4270
218	400	None	None	182	50	4044
218	400	None	None	182	50	4141
231	388	Ball & Socket Assembly	Ball & Socket Assembly	158	250	4295
231	388	Ball & Socket Assembly	Ball & Socket Assembly	158	350	4297
232	380	Ball Stud	Socket	148	360	4084
240	365	Bracket	Ball/Socket	125	450	4165
243	450	None	None	207	50	4142
244	404	Socket	Socket	160	390	4323
246	450	None	None	204	50	4045
253	388	Ball Stud	Ball Stud	135	350	4298
267	450	Socket	Socket	183	550	4313
268	500	None	None	232	50	4143
270	500	None	None	230	50	4046
272	469	Clevis	Clevis	197	320	4081
274	472	Socket	Socket	198	330	4308
281	488	Ball Stud	Ball Stud	207	750	4127
282	458	Socket	Socket	176	430	4331
282	486	Socket	Socket	204	510	4080
282	486	Ball Stud	Ball Stud	204	250	4205
283	487	Plastic Socket	Metal Socket	205	170	4098
284	488	Ball & Socket Assembly	Ball & Socket Assembly	205	250	4294
284	488	Ball & Socket Assembly	Ball & Socket Assembly	205	350	4296
285	493	Bracket	Ball Stud	208	800	4502
287	497	Ball Stud	Ball Stud	210	150	4271
289	477	Socket	Socket	188	360	4328
289	485	Socket	Socket	196	530	4316
290	496	Socket	Socket	206	500	4314
290	500	Socket	Socket	210	270	4082
291	460	Socket	Socket	169	100	4319
291	500	Clevis	Clevis	209	510	4065
293	550	None	None	257	50	4047
293	550	None	None	257	50	4144
295	500	Socket	Socket	205	420	4325
295	513	Clevis	Socket	218	560	4076
300	500	Socket	Socket	200	690	4326
300	510	Socket	Socket	210	340	4330



GASLIFTS

SORTED BY COLLAPSED AND EXTENDED LENGTHS

Collapsed Length	Extended Length	Body End	Rod End	Stroke	Force in Newtons	Part #
302	500	Clevis	Clevis	198	230	4061
304	514	Ball Stud	Ball Stud	210	550	4221
307	525	Socket	Clevis	218	600	4515
307	525	Socket	Clevis	218	600	4516
310	520	Socket	Socket	210	570	4327
315	525	Socket	Socket	210	140	4333
317	551	Socket	Socket	234	450	4079
318	600	None	None	282	50	4048
318	600	None	None	282	50	4145
322	532	Socket	Socket	210	400	4272
324	549	Clevis	Clevis	225	350	4068
332	543	Socket	Socket	211	340	4277
340	540	Socket	Socket	200	400	4329
343	650	None	None	307	50	4049
343	650	None	None	307	50	4146
345	595	Socket	Socket	250	515	4320
346	597	Socket	Socket	251	350	4260
351	577	Socket	Socket	226	325	4063
351	577	Socket	Socket	226	405	4064
353	578	Bracket	Bracket	225	300	4273
356	638	Ball Stud	Ball Stud	282	400	4207
362	572	Clevis	Clevis	210	250	4099
364	624	Socket	Socket	260	340	4332
368	700	None	None	332	50	4050
368	700	None	None	332	50	4147
372	625	Socket	Socket	253	575	4322
374	625	Clevis	Socket	251	300	4289
386	702	Clevis	Clevis	316	240	4067
393	750	None	None	357	50	4051
393	750	None	None	357	50	4148
397	662	Bracket	Ball Stud	265	500	4162
404	735	Socket	Socket	332	340	4069
407	723	Socket	Socket	316	250	4312
416	722	Clevis	Clevis	306	310	4321
416	722	Socket	Socket	306	280	4324
417	699	Socket	Socket	282	350	4071
418	800	None	None	382	50	4052
418	800	None	None	382	50	4149
442.5	800	Ball Stud	Ball Stud		800	4129
443	669	Socket	Socket	226	390	4087
443	850	None	None	407	50	4150
448	673	Socket	Socket	225	460	4083
468	900	None	None	432	50	4151
492	713	Clevis	Clevis	221	600	4521
492	713	Clevis	Clevis	221	600	4522
493	950	None	None	457	50	4152
508	700	Clevis	Clevis	192	825	4163
518	1000	None	None	482	50	4153
520	843	Ball Stud	Clevis	323	675	4131
525	777	Socket	Bracket	252	550	4199



GASLIFTS

SORTED BY PART NUMBERS

Part #	Collapsed Length	Extended Length	Body End	Rod End	Stroke	Force in Newtons
4003	116	166	Clevis	Clevis	50	130
4040	118	200	None	None	82	50
4041	143	250	None	None	107	50
4042	168	300	None	None	132	50
4043	193	350	None	None	157	50
4044	218	400	None	None	182	50
4045	246	450	None	None	204	50
4046	270	500	None	None	230	50
4047	293	550	None	None	257	50
4048	318	600	None	None	282	50
4049	343	650	None	None	307	50
4050	368	700	None	None	332	50
4051	393	750	None	None	357	50
4052	418	800	None	None	382	50
4060	163	258	Clevis	Clevis	95	350
4061	302	500	Clevis	Clevis	198	230
4063	351	577	Socket	Socket	226	325
4064	351	577	Socket	Socket	226	405
4065	291	500	Clevis	Clevis	209	510
4067	386	702	Clevis	Clevis	316	240
4068	324	549	Clevis	Clevis	225	350
4069	404	735	Socket	Socket	332	340
4071	417	699	Socket	Socket	282	350
4076	295	513	Clevis	Socket	218	560
4079	317	551	Socket	Socket	234	450
4080	282	486	Socket	Socket	204	510
4081	272	469	Clevis	Clevis	197	320
4082	290	500	Socket	Socket	210	270
4083	448	673	Socket	Socket	225	460
4084	232	380	Ball Stud	Socket	148	360
4087	443	669	Socket	Socket	226	390
4098	283	487	Plastic Socket	Metal Socket	205	170
4099	362	572	Clevis	Clevis	210	250
4127	281	488	Ball Stud	Ball Stud	207	750
4129	442.5	800	Ball Stud	Ball Stud		800
4131	520	843	Ball Stud	Clevis	323	675
4140	193	350	None	None	157	50
4141	218	400	None	None	182	50
4142	243	450	None	None	207	50
4143	268	500	None	None	232	50
4144	293	550	None	None	257	50
4145	318	600	None	None	282	50
4146	343	650	None	None	307	50
4147	368	700	None	None	332	50
4148	393	750	None	None	357	50
4149	418	800	None	None	382	50
4150	443	850	None	None	407	50
4151	468	900	None	None	432	50
4152	493	950	None	None	457	50
4153	518	1000	None	None	482	50



EXT. & COL. LENGTHS

GASLIFTS

Automotive and Industrial

GASLIFTS

SORTED BY PART NUMBERS

Part #	Collapsed Length	Extended Length	Body End	Rod End	Stroke	Force in Newtons
4162	397	662	Bracket	Ball Stud	265	500
4163	508	700	Clevis	Clevis	192	825
4164	123	209	None	None	86	50
4165	240	365	Bracket	Ball/Socket	125	450
4199	525	777	Socket	Bracket	252	550
4205	282	486	Ball Stud	Ball Stud	204	250
4207	356	638	Ball Stud	Ball Stud	282	400
4221	304	514	Ball Stud	Ball Stud	210	550
4260	346	597	Socket	Socket	251	350
4268	150	227	Clevis	Clevis	77	470
4269	206	296	Socket	Socket	90	480
4270	215	353	Clevis	Clevis	138	320
4271	287	497	Ball Stud	Ball Stud	210	150
4272	322	532	Socket	Socket	210	400
4273	353	578	Bracket	Bracket	225	300
4277	332	543	Socket	Socket	211	340
4284	181	288	Clevis	Socket	107	500
4285	168	258	M6 Stud	M6 Stud	90	480
4289	374	625	Clevis	Socket	251	300
4291	181	288	Ball Stud	Ball Stud	107	300
4294	284	488	Socket	Socket	205	250
4295	231	388	Socket	Socket	158	250
4296	284	488	Socket	Socket	205	350
4297	231	388	Socket	Socket	158	350
4298	253	388	Ball Stud	Ball Stud	135	350
4308	274	472	Socket	Socket	198	330
4312	407	723	Socket	Socket	316	250
4313	267	450	Socket	Socket	183	550
4314	290	496	Socket	Socket	206	500
4316	289	485	Socket	Socket	196	530
4319	291	460	Socket	Socket	169	100
4320	345	595	Socket	Socket	250	515
4321	416	722	Clevis	Clevis	306	310
4322	372	625	Socket	Socket	253	575
4323	244	404	Socket	Socket	160	390
4324	416	722	Socket	Socket	306	280
4325	295	500	Socket	Socket	205	420
4326	300	500	Socket	Socket	200	690
4327	310	520	Socket	Socket	210	570
4328	289	477	Socket	Socket	188	360
4329	340	540	Socket	Socket	200	400
4330	300	510	Socket	Socket	210	340
4331	282	458	Socket	Socket	176	430
4332	364	624	Socket	Socket	260	340
4333	315	525	Socket	Socket	210	140
4501	170	256	Socket	Socket	86	700
4502	285	493	Bracket	Ball Stud	208	800
4515	307	525	Socket	Clevis	218	600
4516	307	525	Socket	Clevis	218	600
4521	492	713	Clevis	Clevis	221	600
4522	492	713	Clevis	Clevis	221	600



STEERING DAMPERS PARTS LISTING

Part #	Product	Superseding Part # status	Product Type	Position	Year	Make	Model	Derivative
14004	Steering Damper		Fig 15	Front	52-79	Volkswagen	Beetle	PC
14011	Steering Damper		Fig 15	Front	76-98	Land Rover	Range Rover, Discovery	SUV
14011	Steering Damper		Fig 15	Front	76-94	Land Rover	Range Rover	SUV
14012	Steering Damper		Fig 15	Front	81-84	Audi	100,200	PC
14012	Steering Damper		Fig 15	Front	81-03	Isuzu	KB, TF Series	4x2, 4x4
14013	Steering Damper		Fig 15	Front	65-84	Land Rover	Defender	109",110" WB, Series 11, 111
14014	Steering Damper		Fig 15	Front	78-97	Opel	Commodore, Rekord	(Incl. 2500,3800,4100)
14016	Steering Damper	Obsolete	Fig 15	Front	68-77	Ford	F Series	F250 4x4
14017	Steering Damper	Obsolete	Fig 15	Front	74-83	Chevrolet	K Series 4X4	K10, K20, K25
14021	Steering Damper		Fig 15	Front	79-98	Toyota	Hilux	4x4
14022	Steering Damper		Fig 15	Front	82-90	Nissan	Patrol	4x4
14022	Steering Damper		Fig 15	Front	82-90	Nissan	Safari	SUV
14023	Steering Damper		Fig 15	Front	71-85	Toyota	Landcruiser	FJ45, BJ45
14024	Steering Damper		Fig 15	Front	90-98	Toyota	Landcruiser	HZJ 80
14024	Steering Damper		Fig 15	Front	83-99	Toyota	Landcruiser	FJ62, BJ60, BJ75
14032	Steering Damper		Fig 15	Front	84-07	Land Rover	Defender	90, 110 , 130 (incl. Defender,County)
14033	Steering Damper		Fig 15	Front	99-05	Toyota	Hilux	4x4
14040	Steering Damper		Fig 15	Front	93-01	Chrysler	Jeep	Cherokee
14040	Steering Damper		Fig 15	Front	96-06	Chrysler	Jeep	Wrangler 4x4 (TJ)

STEERING DAMPERS TECHNICAL INFORMATION

Collapsed Length	Extended Length	Upper Mounting	Lower Mounting	Accessory Kit	Product Type	Part #
287	444	SE	SM	Fig. 15	14004
306	525	9.5mm Stud	9.5mm Stud	Fig. 15	14011
308	501	RE16	SE10x35	500498	Fig. 15	14040
313	540	11mm Stud	11mm Stud	Fig. 15	14013
313	544	9.5mm Stud	9.5mm Stud	140126	Fig. 15	14016
318	539	10mm Stud	SE10x24	Fig. 15	14014
322	458	RE16	RE16	Fig. 15	14023
328	540	RE16	RE16	Fig. 15	14022
335	563	SE10x24	SE10x24	144215	Fig. 15	14012
340	540	9.5mm Stud	RE17	Fig. 15	14021
360	609	RE16	RE16	142387	Fig. 15	14017
363	613	SE10x24	RE16	Fig. 15	14033
411	674	RE16	RE16	Fig. 15	14024
439	677	9.5mm Stud	SE10x26	Fig. 15	14032

TERMS & CONDITIONS

WARRANTY POLICY

WARRANTY ON GABRIEL SHOCK ABSORBERS

1. This warranty is expressed in lieu of all other warranties and representations express or implied.
2. Gabriel SA warrants that all products supplied to its customers comply with the relevant industry quality standards.
3. The Gabriel shock absorbers warranty is in accordance to the following schedule, subject to the specific restrictions and or warranty limitations which are detailed below.
 - 3.1 Gabriel® shock absorbers used on passenger cars and light commercial vehicles (up to 1 000 kg load capacity), are warranted for a period of 36 (thirty six) months from the date of purchase. This only applies in South Africa, Botswana, Namibia, Swaziland and Lesotho. Zimbabwe, Zambia, Malawi and Mozambique have a warranty as per 3.2 below on all vehicle types. All other countries terms and conditions are available on enquiry.
 - 3.2 Gabriel® shock absorbers used on all other types of vehicles are warranted for a period of 12 (twelve) months from date of sale to user, or 20 000 km, whichever occurs first.
 - 3.3 Gabriel® gas-springs (Gabriel Gaslift®), both industrial and automotive are warranted for a period of 12 (twelve) months from date of sale to user.
- 3.4 From time to time, Gabriel SA may run promotions or programs that strengthen the standard Gabriel Warranty Policy. In all circumstances, Gabriel SA will clearly state any changes to the Original Warranty in all of its communications. If a warranty is requested under the provisions of one of these programs or promotions, Gabriel SA will always ensure that it is processed in line with the specific terms and conditions stated.
4. The Gabriel SA warranty covers all manufacturing defects, but does not cover normal deterioration of product through normal use. Gabriel SA warrants that the products manufactured and or distributed shall be free from defects in material and workmanship.
5. Any product, in respect of which a manufacturing defect has been found, may be returned to Gabriel SA within its warranty period in order for it to be repaired or replaced or to have the purchase price of the product repaid, at Gabriel SA's discretion. The replacement unit will be similarly warranted but only for the balance of the duration of the original warranty.

CONSUMER PROTECTION ACT WARRANTIES

6. In terms of the Consumer Protection Act No. 68 of 2008 (CPA), in the event that a product supplied by Gabriel SA is unsuitable for its intended purpose, of poor quality, not in a good working order, defective, sub-standard or wears out before the reasonable service life of the product and the product is returned to Gabriel SA within six months after delivery of the product to the buyer, Gabriel SA will:
 - a) Repair the product;
 - b) Replace the product; or
 - c) Refund the price of the product.
7. In terms of the CPA, if Gabriel SA is directed to repair the product and within 3 months after that repair, that repair is ineffective or a further problem with the product is discovered, Gabriel SA will then replace the product or refund the price of the product.
8. Gabriel SA will have the right not to provide the remedies set out above to the extent that the CPA does not oblige Gabriel SA to do so in the circumstances of a particular case.

GENERAL CONDITIONS, RESTRICTIONS AND LIMITATIONS

9. The buyer of the product must make use of Gabriel SA's returns policy and claims procedure, available on the Gabriel website www.gabriel.co.za, or available directly from the company or any of its representatives. Except to the extent impermissible in terms of the CPA, no warranty claims will be approved by Gabriel SA unless these returns policy and claims procedures are followed.
10. Notwithstanding the returns policy but subject to the CPA, Gabriel SA reserves the right to at any stage reject the return of goods, should it feel that the goods have been abused or that the goods have deteriorated through excessive use within the warranty period. Gabriel SA shall then have the option to return the rejected goods to the buyer.
11. Gabriel SA shall not be liable for damages resulting from delays in shipment or inability to ship due to normal production and shipment delays or those resulting from acts of God, fires, floods, wars, sabotage, accidents, labour disputes or shortages, plant shutdown or equipment failure, voluntary or involuntary compliances with any law, order, rule or regulation of governmental agency or authority; or inability to obtain material (including power and fuel), equipment or transportation, or arising from any other contingency, circumstances or event beyond the control of Gabriel SA.
12. All Gabriel products are fit for purpose for which they have been supplied. In the case of products listed in this catalogue, products should only be used on the vehicles described and under operating conditions appropriate to these vehicles. The warranty does not extend to vehicles with lowered or modified suspensions and only to goods where the user can prove that such goods became defective in normal and proper use.
13. Except to the extent permissible in terms of the CPA, Gabriel SA will not be liable for any loss of profit or any consequential loss or damage, from whatever cause arising, including loss of any labour or fitment costs.
14. The above warranty only applies within the warranty period and when proof of purchase can be verified. A copy of the customer's original purchase invoice is required for all warranty claims. The customer's details should be provided with the claim.
15. Under no circumstances will warranty claims be entertained if the piston rod of the faulty unit has sustained any damage that appears to have been inflicted by tools
16. The warranty will be void if bump rubbers are not used.

PROCESSING WARRANTIES & EXTENDED WARRANTIES

For your ease and convenience, Gabriel SA have created a single telephone number to register either a Warranty or an Extended Warranty.

This number is **0861 GABRIEL (0861 422 7435)**

REGISTERING A NORMAL GABRIEL WARRANTY (GAINING INSTANT APPROVAL)

- 1) To assist in the quick processing of claims through the Warranty Call Centre, it is important to have the following information with you prior to making the call:
 - a. The vehicle make, model and year that the part was fitted to.
 - b. The claimed product part number
 - c. The claimed manufacturing date code (required unless the product is still fitted)
 - d. The original invoice with date of issue and invoice number
 - e. The type of fault or customer complaint (this relates to the documented fault codes presented in the catalogue)
 - f. The motorist's name and phone number (optional)
 - g. The extended warranty registration number (if applicable)
- 2) Call 0861 GABRIEL (0861 422 7435) and request to log a standard Warranty Claim
- 3) A call centre agent will ask you the questions stated in No.1 above and should the answers fall in line with our warranty policy, a preauthorisation claim number will be issued (RMA Number). It is this number that is to be recorded along with your own request for credit documentation (RFC) back to your product supplier. We advise that this RMA number is physically written on the product with either a Black or White paint pen prior to returning the product back.
- 4) Should an RMA not be issued, the reason will be explained to you by the call center agent.
- 5) Gabriel SA can allow you the option to submit your requests for credit with your supplier, however you must first confirm with your supplier that they are happy to receive a claimed product without an RMA number. Further there are no guarantees that the claim will be honoured, as this is based on an inspection required by a Gabriel Representative who may reject the claim.
- 6) In line with its Warranty Policy, Gabriel honours all of its product from any store that a warranty is claimed from, irrespective of where the customer initially purchased the product from. If you are not the original seller, it is still your responsibility to validate if a customer has a valid claim and to process the claim in line with this procedure. We so advise that you make a copy of the claimed invoice for your records.
- 7) For further enquiries, please feel free to contact our offices or your Gabriel Representative.
- 8) See below for warranty fault codes required for your registration.

GAINING AND REGISTERING AN EXTENDED WARRANTY

The information below has been compiled to assist with the smooth implementation of Gabriel Extended Warranty process.

- Your Gabriel representative will provide you with the physical extended warranty book.
- The customer can purchase an extended warranty on either his shocks or struts which will increase the standard warranty period for an additional 2 years irrespective of the Km travelled. I.e. From a standard 3 year warranty to a 5 year, unlimited kilometre warranty.
- Each book contains 20 certificates with 2 shock / strut warranties per page (most products are sold in pairs), so this equates to a total of 40 shocks and struts that the extended warranty can be offered per book.
- Your Gabriel representative will explain in detail the costs around the extended warranty program.
- The extended warranties are to be sold at the time of original purchase of the shock or strut and are only to be sold against Gabriel® Shock Absorber Products.
- The terms and conditions of the extended warranty is contained on each certificate sold.
- Extended warranty marketing support is also available free of charge from your Gabriel Representative.
- Once a customer purchases an extended warranty, it is the seller's responsibility to fully complete all the information required on the certificate. The customer retains their certificate with their original product proof of purchase.
- The customer has 30 (Thirty) days to register their extended warranty by calling **0861 GABRIEL (0861 422 7435)**. On registration, the following information will be required to activate the extended warranty and all of this information should be completed on an Extended Warranty Certificate.
 - Customer's Name
 - Customer's address
 - ID number (optional)
 - Selling outlet of the extended Warranty
 - Vehicle make, model
 - Part number purchased
 - Extended warranty certificate number
 - Original purchase invoice number
 - Contact number.
- To redeem an extended warranty at any retail store nationally, the above warranty claim process is to be followed. Any outlet claiming an extended warranty must ensure that the terms and conditions on the reverse of the certificate were and are honoured and that the registration number and physical certificate is present. By doing so, this allows the call centre to issue an immediate pre authorization number for credit.

8 SIGNS OF WORN SHOCKS

Be safe. Be sure



www.gabriel.co.za



[GabrielShocksZA](https://www.facebook.com/GabrielShocksZA)



[gabrielshocksza](https://twitter.com/gabrielshocksza)



Brands of Torre Automotive



GABRIEL manufactures a comprehensive range of dampers that are designed and engineered to suit the conditions of South African roads. These are available in shock absorbers, spring seat shocks, struts, strut cartridges and steering dampers. **GABRIEL** also manufactures gas springs that ease the opening and closing of car boots, bonnets, hatches, hatchback windows and canopies. **GABRIEL** products are all designed and manufactured in accordance to strict ISO9001 standards, which allows **GABRIEL** products to be trusted by all who use them... **GABRIEL** "Be Safe, Be Sure".
SHOCKS . STRUTS . GASLIFTS . CARTRIDGES . 4X4 SHOCKS



AUTOCOM has been recognized as a leading brand in the suspension and steering market for more than 35 years, and continues to remain at the forefront of the suspension market through technical agreements with global OEM manufacturers. Because suspension and steering parts are subjected to exceptional stresses during every day driving, **AUTOCOM** components are manufactured from only the highest quality material and are machined to OEM-defined tolerances.
BALL JOINTS . STEERING RACKS . CONTROL ARMS . TIE ROD ENDS . LINKS . UNIVERSAL JOINTS



ECHLIN is acknowledged as a leading brand in the Engine Systems category, with its comprehensive range of under bonnet products, which include ignition, fuel, cooling, switches and sensors, as well as a full range of auto electrical components. For nearly 60 years **ECHLIN** has remained at the forefront of product range development, boasting the widest range of radiator caps, oil filler caps, locking caps, ignition products, water pumps, fuel pumps, carburetor kits, thermostats, switches and sensors, starters, alternators and auto electrical accessories in the South African automotive aftermarket.
ECHLIN is the industry reference in range and quality.
IGNITION . FUEL . COOLING . SWITCHES AND SENSORS . ELECTRICAL ACCESSORIES . AUTO ELECTRICAL



VDO is a global brand providing state of the art automotive electronic and mechatronic solutions capturing the automotive aftermarket. **VDO** is a premium brand in the Engine Systems category, and complies with the highest levels of OE standards with regards to quality, longevity, accurate fitment and safety. The extensive range of **VDO** quality products cover the automotive, marine, commercial, industrial and specialized OE market. The **VDO** brand embodies the principles of individual mobility, driving pleasure, safety, environmental responsibility and cost efficiency, and is a perfect complementary range to the Echlin brand in the Engine Systems category.
INSTRUMENTATION . SENSORS AND SENDERS . COMMON RAIL DIESEL SYSTEMS . TANK UNITS . TACHOGRAPHS . GAUGES



TEXTAR is a globally recognized brand synonymous with premium friction products with over a 100 years of experience in supplying friction product worldwide. **TEXTAR** is associated with only the highest level of quality, providing optimum safety and the highest braking comfort worldwide. **TEXTAR** also offers the widest range of products and services for passenger cars currently in the market. In the commercial vehicles sector, 70% of vehicles with drum brakes, and 50% of those with disc brakes, leave the OE assembly line already fitted with **TEXTAR** friction products.
BRAKE PADS . BRAKE DISCS . BRAKE SHOES . BRAKE LININGS . BRAKE SYSTEM ACCESSORIES



MAG BRAKES a true South Africa brand in the heavy-duty airbrake market is widely acclaimed for its supply of quality airbrake parts and hydraulic cylinders to the brake industry. **MAG BRAKES** is not only recognized for their extensive range of airbrake, brass and steel fittings, adaptors and comprehensive range of hoses, couplings and Air brake accessories, but also for their design and installation of ABS, EBS and hydraulic brake kits for trucks and trailers in compliance with SABS specification.
BRAKE BOOSTERS . SUZIE HOSES . COUPLINGS . COMPRESSORS . ACTUATORS . VALVES . AIR BRAKE SYSTEMS



VISION X, has been providing lighting solutions demanded by the market as well as innovating the next step for lighting for the past 15 years. With **VISION X** release of the HID series in 2005, **VISION X** was the first to provide an HID internal ballast and starter to mass market, simplifying installation and reducing external components. Again in 2008 **VISION X** revolutionized lighting with the LED bar originally produced for NASA's Back to the Moon Mission. Since then, **VISION X** has continued innovation with the Solo Pod, its heavy duty LED lighting for use in mining, industrial and commercial applications, and it's LED Light Cannon, which transforms a single LED into 1000 feet of usable light. **VISION X** will continue to innovate in the lighting market, and live up to the brands motto of "Lighting Evolved."
LED, HID AND HALOGEN LIGHTING SOLUTIONS . SPOTLIGHTS . LIGHT BARS . MINING EQUIPMENT LIGHTING . STRUCTURAL LIGHTING



TRUCK-LITE has been providing visibility systems since 1955 and continues to remain a leading global brand in the Truck and Trailer market and have always been at the forefront of innovation. From the era of bulb replaceable metal lights to sealed and shock resistant polycarbonate lights, from bulbs to light emitting diodes, **TRUCK-LITE** continues to innovate and provides quality products "from the front of the truck to the rear of the trailer."
LAMPS . CHEVRONS . WARNING TRIANGLES . GLOBES . REFLECTORS . DRIVING LIGHTS . SPOTLIGHTS



WARN, with more than 60 years of research, development and manufacturing experience, it is undoubtedly the premium global winch brand. Manufactured for extreme performance, **WARN** provides a range of winches for automotive, industrial, commercial and recreational needs as well as a full range of off-road accessories. **WARN'S** commitment to engineering excellence can be seen in the products quality, durability and innovation.
WINCHES . HOISTS . WINCHING ACCESSORIES



HI-LIFT jacks are just about the most versatile piece of off road equipment you can buy. It doesn't matter if you are in the Namib dessert, the African jungle, or the Bushveld, **HI-LIFT** jacks are designed to help you survive the most demanding situation. Manufactured to the most exacting standards, with only the highest quality material to withstand the demands of these conditions, it will never let you down.
JACKS . LIFTING ACCESSORIES



HEAD OFFICE

JOHANNESBURG

Torre Automotive (Pty) Ltd

59 Merino Avenue, City Deep, Johannesburg, South Africa

P.O. Box 86222, City Deep, 2049, South Africa

Tel: +27(0)11 627 2500

Fax: +27(0)11 627 2600

Sharecall: 0861 242 886

info@torreautomotive.co.za

www.torreautomotive.co.za



www.gabriel.co.za



Gabriel Shocks ZA



[gabrielshocksza](https://twitter.com/gabrielshocksza)



7M.03.15

Download a recognised QR reader on your mobile device for quick access to the Gabriel web page.